

**TESTING FOR THE VERIFICATION OF COMPLIANCE OF PV INVERTER WITH:  
EN 50549-1: 2019:**

**REQUIREMENTS FOR GENERATING PLANTS TO BE CONNECTED IN PARALLEL  
WITH DISTRIBUTION NETWORKS - PART 1: CONNECTION TO A LV  
DISTRIBUTION NETWORK - GENERATING PLANTS UP TO AND INCLUDING  
TYPE B**

**(REQUIREMENTS FOR PLANTS TYPE B)**

**Procedure: PE.T-LE-62**

Test Report Number .....: 221/0362-3-E1 (\*)

*(\*) This Test Report supersedes Test Report no. 2221/0362-3, see Test Report Historical revision table on page 2.*

Type .....: Solar Grid-tied Inverter

Tested Model .....: **SOFAR 50KTLX-G3**

Trade Mark .....: 

Variant Models .....: SOFAR 25KTLX-G3,  
SOFAR 30KTLX-G3, SOFAR 30KTLX-G3-A,  
SOFAR 33KTLX-G3, SOFAR 36KTLX-G3,  
SOFAR 40KTLX-G3, SOFAR 45KTLX-G3,  
SOFAR 40KTLX-G3-HV, SOFAR 50KTLX-G3-HV.

**APPLICANT**

Name .....: **SGS Tecnos, S.A. (Certification Body)**

Address .....: C/ Trespaderne, 29 - Edificio Barajas 1  
28042 Madrid (Spain)

**HIRED BY**

Name .....: **Shenzhen SOFARSOLAR Co., Ltd.**

Address .....: 11/F., Gaoxingqi Technology Building, No.67 Area, Xingdong  
Community, Xin'an Sub-district, Bao'an District, Shenzhen  
City, Guangdong Province, P.R. China

**TESTING LABORATORY**

Name .....: **SGS Tecnos, S.A. (Electrical Testing Laboratory)**

Address .....: C/ Trespaderne, 29 - Edificio Barajas 1  
28042 Madrid (Spain)

Conducted (tested) by .....: Roger Hu  
(Project Engineer)



Approved by .....: Miguel Rodriguez  
(Technical Reviewer)

Date of issue .....: 2022/03/17

Number of pages .....: 293

**Important Note:**

- This document is issued by the Company under its General Conditions of service accessible at [http://www.sgs.com/terms\\_and\\_conditions.htm](http://www.sgs.com/terms_and_conditions.htm). Attention is drawn to the limitation of liability, indemnification and jurisdiction issues defined therein. Any holder of this document is advised that information contained hereon reflects the Company's findings at the time of its intervention only and within the limits of Client's instructions, if any. The Company's sole responsibility is to its Client and this document does not exonerate parties to a transaction from exercising all their rights and obligations under the transaction documents.
- Any unauthorized alteration, forgery or falsification of the content or appearance of this document is unlawful and offenders may be prosecuted to the fullest extent of the law.
- Unless otherwise stated the results shown in this test report refer only to the sample(s) tested as received. Information of derived or extension models of the range as provided by the applicant, (if any), is included in this report only for informative purposes. The Company SGS shall not be liable for any incorrect results arising from unclear, erroneous, incomplete, misleading or false information provided by Client. This document cannot be reproduced except in full, without prior approval of the Company.

**Test Report Historical Revision:**

Test Report Version	Date	Resume
2221/0362-3	2022/01/14	First issuance
2221/0362-3-E1	2022/03/17	Update report to add deviations for interface protection for Poland, The Netherlands and Ireland according to EN 50438: 2013 and add deviations for interface protection stated by default according to EN 50549-1: 2019 that are used in Greece and Turkey.

**INDEX**

<b>1.</b>	<b>SCOPE .....</b>	<b>4</b>
<b>2.</b>	<b>GENERAL INFORMATION .....</b>	<b>5</b>
2.1.	Testing Period and Climatic conditions .....	5
2.2.	Equipment under Testing .....	6
2.3.	Reference Values .....	11
2.4.	Test equipment list .....	12
2.5.	Measurement uncertainty .....	13
2.6.	Test set up of the different standard .....	14
2.7.	Factory Information .....	14
2.8.	Definitions .....	15
<b>3.</b>	<b>RESUME OF TEST RESULTS .....</b>	<b>16</b>
<b>4.</b>	<b>TEST RESULTS .....</b>	<b>18</b>
4.1.	Normal operating range .....	18
4.1.1.	Operating frequency range .....	18
4.1.2.	Minimal requirement for active power delivery at underfrequency .....	20
4.1.3.	Continuous operating voltage range .....	22
4.2.	Immunity to disturbances .....	23
4.2.1.	Rate of change of frequency (ROCOF) immunity .....	23
4.2.2.	Under-voltage ride through (UVRT) .....	24
4.2.3.	Over-voltage ride through (OVRT) .....	64
4.3.	Active response to frequency deviation .....	95
4.3.1.	Power response to overfrequency .....	95
4.3.2.	Power response to underfrequency .....	100
4.4.	Power response to voltage changes .....	100
4.4.1.	Setpoint control modes .....	100
4.4.2.	Voltage related control mode .....	113
4.4.3.	Voltage related active power reduction (Volt-Watt) .....	124
4.4.4.	Short circuit current requirements on generating plants .....	127
4.5.	EMC and power quality .....	128
4.5.1.	Harmonic emissions .....	129
4.5.2.	Flicker and voltage fluctuations .....	132
4.6.	Interface protection .....	138
4.6.1.	Requirements on voltage and frequency protection (Country / Region included in the default settings: Greece and Turkey) .....	138
4.6.2.	Requirements on voltage and frequency protection (Country / Region included in the default settings: Ireland) .....	168
4.6.3.	Requirements on voltage and frequency protection (Country / Region included in the default settings: The Netherlands) .....	202
4.6.4.	Requirements on voltage and frequency protection (Country / Region included in the default settings: Poland) .....	237
4.6.5.	Means to detect island situation .....	273
4.6.6.	Digital input to the interface protection .....	276
4.7.	Connection and starting to generate electrical power .....	276
4.7.1.	Automatic reconnection after tripping .....	276
4.7.2.	Starting to generate electrical power .....	279
4.7.3.	Synchronization .....	282
4.8.	Ceasing and reduction of active power on set point .....	282
4.8.1.	Ceasing active power .....	282
4.8.2.	Reduction of active power on set point .....	283
4.9.	Requirements regarding single fault tolerance of interface protection system and interface switch .....	284
<b>5.</b>	<b>PICTURES .....</b>	<b>285</b>
<b>6.</b>	<b>ELECTRICAL SCHEME .....</b>	<b>293</b>

## 1. SCOPE

SGS Tecnos, S.A. (Electrical Testing Laboratory) has been contracted by SGS Tecnos, S.A. (Certification Body) to perform the testing according the EN 50549 – 1: 2019: Requirements for generating plants to be connected in parallel with distribution networks - part 1: connection to a LV distribution network - generating plants up to and including type B.

The tests offered at this test report evaluate the EUT compliance with the requirements of **Type B**.

The deviations for interface protection for Greece and Turkey are the same as the requirement of EN 50549-1: 2019.

The deviations for interface protection for Poland, The Netherlands and Ireland are according to EN 50438: 2013.

**2. GENERAL INFORMATION**

**2.1. TESTING PERIOD AND CLIMATIC CONDITIONS**

The necessary testing of **2221/0362-3** has been performed between 05<sup>th</sup> August and 04<sup>th</sup> December of 2021.

The necessary testing of **2221/0362-3-E1** has been performed between 21<sup>st</sup> February and 26<sup>th</sup> February of 2022.

All the tests and checks have been performed at climatic conditions:

Temperature	25 ± 5 °C
Relative Humidity	50 ± 10 %
Pressure	96 ± 10 kPa

**SITE TEST 1 (Test date: 05<sup>th</sup> August and 04<sup>th</sup> December of 2021)**

Name ..... : **Shenzhen SOFARSOLAR Co., Ltd.**  
 Address ..... : 401, Building 4, AnTongDa Industrial Park, District 68,  
 XingDong Community, XinAn Street, BaoAn District,  
 Shenzhen City, Guangdong Province, P.R. China

**SITE TEST 2 (Test date: 21<sup>st</sup> February and 26<sup>th</sup> February of 2022)**

Name ..... : **Shenzhen SOFARSOLAR Co., Ltd.**  
 Address ..... : 11/F., Gaoxinqi Technology Building, No.67 Area,  
 Xingdong Community, Xin'an Sub-district, Bao'an District,  
 Shenzhen City, Guangdong Province, P.R. China

**2.2. EQUIPMENT UNDER TESTING**









Apparatus type .....	Solar Grid-tied Inverter
Installation .....	Fixed installation
Manufacturer .....	<b>Shenzhen SOFARSOLAR Co., Ltd.</b>
Trade mark .....	
Model / Type reference .....	<b>SOFAR 50KTLX-G3</b>
Serial Number .....	SS3ES250M7F022
Software Version .....	V000001
Rated Characteristics .....	DC input: 180-1000 V <sub>MPPT</sub> (Max.1100 V), 4*40 A AC output: 3/N/PE, 230 V <sub>ac</sub> , 50 Hz, 72.5 A (Max.83.3 A), 50 kW (Max.55 kVA)

Date of manufacturing: 2021

## Test item particulars

Input.....	DC
Output.....	AC
Class of protection against electric shock...	Class I
Degree of protection against moisture .....	IP 65
Type of connection to the main supply.....	Three Phase – Fixed installation
Cooling group .....	Fan
Modular .....	No
Internal Transformer .....	No

## Copy of marking plate:

 <b>Solar Grid-tied Inverter</b>	
Model No:	SOFAR 50KTLX-G3
Max.DC Input Voltage	1100V
Operating MPPT Voltage Range	180~1000V
Max. Input Current	4*40A
Max. PV Isc	4*50A
Nominal Grid Voltage	3/N/PE,230/400V
Max.Output Current	83.3A
Nominal Grid Frequency	50/60Hz
Nominal Output Power	50000W
Max.Output Power	55000VA
Power Factor	1 (adjustable+/-0.8)
Ingress Protection	IP65
Operating Temperature Range	-30°C~+60°C
Protective Class	Class I
Inverter Topology	Non-Isolated
Overvoltage Category	AC III,DC II
Manufacturer : Shenzhen SOFARSOLAR Co.,Ltd. Address : 11/F., Gaoxinqi Technology Building, No.67 Area, Xingdong Community, Xin'an Sub-district, Bao'an District, Shenzhen City,China	
VDE0126-1-1,VDE-AR-N4105,G99,IEC61727 IEC62116,UTE C15-712-1,AS4777	
       	

**Note:**

- 1.The above markings are the minimum requirements required by the safety standard. For the final production samples, the additional markings which do not give rise to misunderstanding may be added.
- 2.Label is attached on the side surface of enclosure and visible after installation
- 3.Labels of other models are as the same with SOFAR 50KTLX-G3's except the parameters of rating.

**Equipment Under Testing:**

- SOFAR 50KTLX-G3

**Variant models:**

- SOFAR 25KTLX-G3
- SOFAR 30KTLX-G3
- SOFAR 30KTLX-G3-A
- SOFAR 33KTLX-G3
- SOFAR 36KTLX-G3
- SOFAR 40KTLX-G3
- SOFAR 45KTLX-G3
- SOFAR 40KTLX-G3-HV
- SOFAR 50KTLX-G3-HV

The variant models have been included in this test report without tests because the following features don't change regarding to the tested model:

- Same connection system and hardware topology.
- Same control algorithm.
- Output power within  $1/\sqrt{10}$  and 2 times of the rated output power of the EUT or Modular inverters.
- Same Firmware Version.

Equipment ratings and parameters have been provided by the manufacturer.

The models of SOFAR 25KTLX-G3, SOFAR 30KTLX-G3, SOFAR 30KTLX-G3-A, SOFAR 33KTLX-G3, SOFAR 36KTLX-G3, SOFAR 40KTLX-G3, SOFAR 45KTLX-G3, SOFAR 50KTLX-G3, SOFAR 40KTLX-G3-HV and SOFAR 50KTLX-G3-HV are identical on topological schematic circuit diagram and control solution codes except for the type designation, the input/output rating.

The models with suffix -HV means the output voltage is 277 / 480 V(3/N/PE or 3/PE) and the others are for 230 / 400 V(3/N/PE).



Following table shows the full ratings of the all models referenced in this report, marked in **bold letters** the ones subjected to testing:

<b>Model</b>	<b>SOFAR 25KTLX-G3</b>	<b>SOFAR 30KTLX-G3</b>	<b>SOFAR 30KTLX-G3-A</b>	<b>SOFAR 33KTLX-G3</b>	<b>SOFAR 36KTLX-G3</b>
<b>DC Input</b>					
Max. DC voltage	1100 V				
Rated input voltage	620 V				
Start-up operating voltage	200 V				
MPPT voltage range	180 V~1000 V				
Full power MPPT voltage range	480 V-850 V	480 V-850 V	480 V-850 V	510 V-850 V	540 V-850 V
Max. input current	3*40 A				
Max. input short circuit current	3*50 A				
<b>AC Output</b>					
Rated AC Output power	25 kW	30 kW	29.9 kW	33 kW	36 kW
Max. AC Output power	28 kVA	34 kVA	29.9 kVA	37 kVA	40 kVA
Rated current	36.2 A	43.5 A	43.3 A	47.8 A	52.2 A
Max. output current	42.4 A	51.5 A	45.3 A	56.0 A	60.6 A
Nominal grid voltage	3/N/PE, 230 / 400 V				
Nominal output frequency	50 Hz				
Output power factor	1 default (adjustable +/-0.8)				
Operating temperature range	-30 °C ~60 °C				
Ingress protection	IP65				
Protective class	Class I				

<b>Model</b>	<b>SOFAR 40KTLX-G3</b>	<b>SOFAR 45KTLX-G3</b>	<b>SOFAR 50KTLX-G3</b>	<b>SOFAR 40KTLX-G3-HV</b>	<b>SOFAR 50KTLX-G3-HV</b>
<b>DC Input</b>					
Max. DC voltage	1100 V				
Rated input voltage	620 V			725 V	
Start-up operating voltage	200 V				
MPPT voltage range	180 V~1000 V				
Full power MPPT voltage range	480 V-850 V	510 V-850 V	540 V-850 V	620 V-850 V	650 V-850 V
Max. input current	4*40 A	4*40 A	4*40 A	3*40 A	4*40 A
Max. input short circuit current	4*50 A	4*50 A	4*50 A	3*50 A	4*50 A
<b>AC Output</b>					
Rated AC Output power	40 kW	45 kW	50 kW	40 kW	50 kW
Max. AC Output power	44 kVA	50 kVA	55 kVA	44 kVA	55 kVA
Rated current	58.0 A	65.2 A	72.5 A	48.1 A	60.2 A
Max. output current	66.7 A	75.8 A	83.3 A	53.0 A	66.2 A
Nominal grid voltage	3/N/PE, 230 / 400 V			3/N/PE or 3/PE, 277 / 480 V	
Nominal output frequency	50 Hz				
Output power factor	1 default (adjustable +/-0.8)				
Operating temperature range	-30 °C ~60 °C				
Ingress protection	IP65				
Protective class	Class I				

The results obtained apply only to the particular sample tested that is the subject of the present test report. The most unfavorable result values of the verifications and tests performed are contained herein. Throughout this report a point (comma) is used as the decimal separator.

### 2.3. REFERENCE VALUES

The values presented in the following table have been used for calculation of referenced values (p.u.; %) though the report.

Model: SOFAR 50KTLX-G3	
Rated power, <b>P<sub>n</sub></b> in kW	50
Design active power, <b>P<sub>D</sub></b> in kW <sup>(1)</sup>	50
Maximum apparent power, <b>S max</b> in kVA	55
Rated wind speed (only WT), <b>v<sub>n</sub></b> in m/s	N/A
Rated current (determined), <b>I<sub>n</sub></b> in A	72.5
Rated output voltage, (Line to Neutral) <b>U<sub>n</sub></b> in Vac	230
Note: In this report p.u. values are calculated as follows: -For Active & Reactive Power p.u values are reference to <b>S<sub>n</sub></b> -For Currents p.u values, the reference is always <b>I<sub>n</sub></b> -For Voltages p.u values, the reference is always <b>U<sub>n</sub></b>	

<sup>(1)</sup> Manufacturer's declaration:  $P_D$  equals to 1.0 times of Rated AC Output power, according to measured  $P_D \approx 1.0 P_n$  (49.759 kW)

## 2.4. TEST EQUIPMENT LIST

Equipment used between 05<sup>th</sup> August and 04<sup>th</sup> December of 2021:

From	No.	Equipment Name	MARK / Model No.	Equipment No.	Calibration Period
SofarSolar	1	Digital oscilloscope	Tektronix / MD03024	C055210	2021/01/05 to 2022/01/04
	2	Voltage probe	SanHua/SI-9110	152655	2021/01/05 to 2022/01/04
	3	Voltage probe	SanHua/SI-9110	111134	2021/01/05 to 2022/01/04
	4	Voltage probe	SanHua/SI-9110	111539	2021/01/05 to 2022/01/04
	5	Voltage probe	SIGLENT/ DPB5150A	D15A150052	2021/01/05 to 2022/01/04
	6	Current probe	CYBERTEK/ CP1000A	C181000922	2021/01/05 to 2022/01/04
	7	Current probe	CYBERTEK/ CP1000A	C181000929	2021/01/05 to 2022/01/04
	8	Current probe	CYBERTEK/ CP1000A	C191000141	2021/01/05 to 2022/01/04
	9	Current probe	DANISENSE/ IIT300	20203031300378	2021/05/18 to 2022/05/17
	10	Power analyzer	ZhiYuan/ PA5000H	C8202909082002 110002	2021/01/05 to 2022/01/04
	11	Temperature & Humidity meter	Anymeters/ HTC-1	WSDJ-007	2020/12/28 to 2021/12/27
SGS	12	True RMS Multimeter	Fluke/289C	GZE012-53	2021/01/18 to 2022/01/17

Equipment used between 21<sup>st</sup> February and 26<sup>th</sup> February of 2022:

From	No.	Equipment Name	MARK / Model No.	Equipment No.	Calibration Period
SofarSolar	1	Power analyzer	ZLG/ PA6000H	BZ-DGD-L059	2021/10/22 to 2022/10/21
	2	Current probe	Fluke/ CP1000A	C191000142	2021/12/21 to 2022/12/20
	3	Current probe	Fluke/ CP1000A	C191000127	2021/12/21 to 2022/12/20
	4	Current probe	Fluke/ CP1000A	C191000124	2021/12/21 to 2022/12/20
	5	Digital oscilloscope	Tektronix/ MD03024	C055210	2021/12/21 to 2022/12/20
	6	Voltage probe	SanHua/SI-9110	111539	2021/12/21 to 2022/12/20
	7	Voltage probe	SanHua/SI-9110	111541	2021/12/21 to 2022/12/20
	8	Voltage probe	SanHua/SI-9110	111134	2021/12/21 to 2022/12/20
	9	Temperature & Humidity meter	Anymeters/ TH101B	ZB-WSDJ-001	2021/12/21 to 2022/12/20
	10	Digital oscilloscope	SIGLENT/ SDS1102X	SDS1XDCC1L46 28	2021/12/21 to 2022/12/20
SGS	11	True RMS Multimeter	Fluke/187	GZE012-8	2021/11/19 to 2022/11/18

Note: Voltage direct measurement through power analyzer, the voltage probes were used with the digital oscilloscope. All measurement equipment was used inside their corresponding calibration period. Copy of all calibration certificates are available at the laboratory for reference.

## 2.5. MEASUREMENT UNCERTAINTY

Associated uncertainties through measurements showed in this report are the maximum allowable uncertainties.

Magnitude	Uncertainty
Voltage measurement	$\pm 1.5 \%$
Current measurement	$\pm 2.0 \%$
Frequency measurement	$\pm 0.2 \%$
Time measurement	$\pm 0.2 \%$
Power measurement	$\pm 2.5 \%$
Phase Angle	$\pm 1^\circ$
Temperature	$\pm 3^\circ\text{C}$

Note1: Measurements uncertainties showed in this table are maximum allowable uncertainties. The measurement uncertainties associated with other parameters measured during the tests are in the laboratory at disposal of the petitioner.

Note2: Where the standard requires lower uncertainties that those in this table. Most restrictive uncertainty has been considered.

**2.6. TEST SET UP OF THE DIFFERENT STANDARD**

Below is the simplified construction of the test set up.

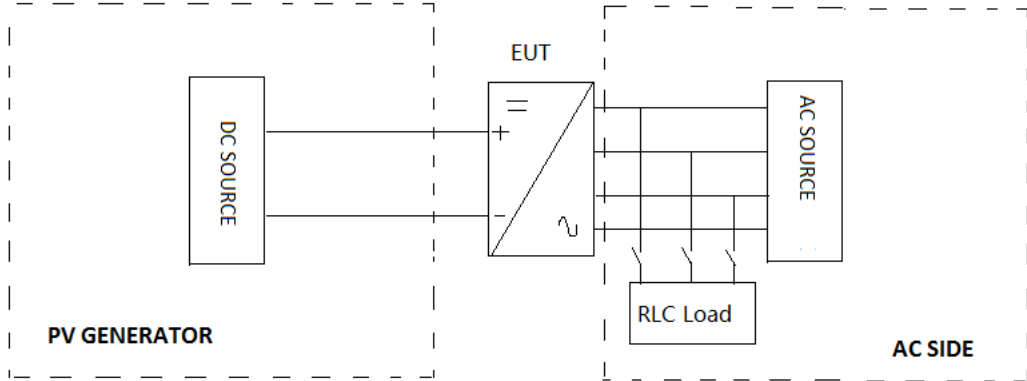

Different equipments have been used to take measures as shown in chapter 2.4. Current and voltage clamps have been connected to the inverter input / output for all the tests.

All the tests described in the following pages have used this specified test setup.

**The test bench used includes:**

EQUIPMENT	MARK / MODEL	RATED CHARACTERISTICS	OWNER / ID.CODE
AC source	Wogo / WLPA-33-1000kVA	1000 kVA 5-400 V <sub>rms</sub> 44.5-65.5 Hz	--
DC source	Wogo / WDGC-1000kW	0 – 1500 Vdc (0.01 V step) 0 – 1333 A (0.01 A step)	--
RLC load	Qunlin / ACLT3816H	563.3kW, 563.3kVAr	--

**2.7. FACTORY INFORMATION**

Factory Name ..... : **Dongguan SOFAR SOLAR Co., Ltd.**

Factory Address ..... : 1F - 6F, Building E, No. 1 JinQi Road, Bihu Industrial Park, Wulian Village, Fenggang Town, Dongguan City, Guangdong Province, P.R. China.

**2.8. DEFINITIONS**

EUT	Equipment Under Testing	Hz	Hertz
A	Ampere	V	Volt
Un	Nominal Voltage	p.u	Per unit
In	Nominal Current	Pn	Rated Active Power
Ia	Active Current	Qn	Rated Reactive Power
Ir	Reactive Current	Sn	Rated Apparent Power
MV	Medium Voltage	THC	Total Harmonic Current
LV	Low Voltage	TDD	Total Demand Distortion
UVRT	Under-Voltage Ride Through	I <sub>h</sub>	Harmonic Current
OVRT	Over-Voltage Ride Through	Plt	Severity of Flicker Long-Term
Pst	Severity of Flicker Short-Term	ms	Millisecond
dc	Maximum Variation of Voltage	s	Second
d max	Maximum Absolute Value of Voltage Variation	min	Minute
fn	Nominal frequency	P	Active Power
IGBT	Insulated-Gate Bipolar Transistor	Q	Reactive Power
RMS	Root Mean Square	PF	Power Factor
S <sub>k, fic</sub>	Short-circuit apparent power	Nr.	Number
AC	Alternating Current	POC	Point of Connection
DC	Direct Current	Meas.	Measured
DSO	Distribution System Operator	Des.	Desired
EES	Electrical energy storage system	PGU	Power Generating Unit
EES	Electrical energy storage	P <sub>D</sub>	Design active power
Pmax	Maximum active power	P <sub>M</sub>	Momentary active power
P <sub>A</sub>	Available active power	Smax	Maximum apparent power

### 3. RESUME OF TEST RESULTS

#### INTERPRETATION KEYS

Test object does meet the requirement ..... **P** Pass  
 Test object does not meet the requirement ..... **F** Fails  
 Test case does not apply to the test object ..... **N/A** Not applicable  
 To make a reference to a table or an annex..... See additional sheet  
 To indicate that the test has not been realized..... **N/R** Not realized

EN 50549-1:2019 – Requirements for plant category Type B have been considered.				
REPORT SECTION	STANDARD SECTION	CHAPTER OF THE STANDARD	Plant category	Result
4.1	4.4	Normal operating range	--	--
4.1.1	4.4.2	Operating frequency range	≥A	P
4.1.2	4.4.3	Minimal requirement for active power delivery at underfrequency	≥A	P
4.1.3	4.4.4	Continuous operating voltage range	≥A	P
4.2	4.5	Immunity to disturbances	≥A	P
4.2.1	4.5.2	Rate of change of frequency (ROCOF) immunity	≥A	P
4.2.2	4.5.3	Under-voltage ride through (UVRT)	B	P
4.2.3	4.5.4	Over-voltage ride through (OVRT)	≥A	P
4.3	4.6	Active response to frequency deviation	≥A	P
4.3.1	4.6.1	Power response to overfrequency	≥A	P
4.3.2	4.6.2	Power response to underfrequency	≥A	N/A
4.4	4.7	Power response to voltage changes	≥A	P
4.4.1 and 4.4.2	4.7.2	Voltage support by reactive power	≥A	P
4.4.3	4.7.3	Voltage related active power reduction	≥A	P
4.4.4	4.7.4	Short circuit current requirements on generating plants	B	N/A
4.5	4.8	EMC and power quality	≥A	N/R (1)
4.5.1	4.8	Harmonic emissions	≥A	P
4.5.2	4.8	Flicker and voltage fluctuations	≥A	P
4.6	4.9	Interface protection	≥A	P
4.6.1	4.9.3	Requirements on voltage and frequency protection	≥A	P
4.6.5	4.9.4	Means to detect island situation	≥A	P
4.6.6	4.9.5	Digital input to the interface protection	≥A	P
4.7	4.10	Connection and starting to generate electrical power	≥A	P
4.7.1	4.10.2	Automatic reconnection after tripping	≥A	P
4.7.2	4.10.3	Starting to generate electrical power	≥A	P
4.7.3	4.10.4	Synchronization	≥A	P
4.8	4.11	Ceasing and reduction of active power on set point	≥A	P
4.8.1	4.11.1	Ceasing active power	≥A	P
4.8.2	4.11.2	Reduction of active power on set point	B	P
4.9	4.13 & 4.3	Requirements regarding single fault tolerance of interface protection system and interface switch	≥A	N/R (2)

Note:

Decision rule of the declaration of conformity evaluated according to the ILAC G8: 09/2019 & IEC 115 Guidelines (Proc. 2 “Accuracy Method” based on OD-5014).

Decision rule used: Binary with simple acceptance. (Safety Zone with respect to the limit  $w = 0$ ).

Specific risk: Probability of False Acceptance or Rejection less than 50%, (PFA / PFR <50%). For more information see ILAC Guide G8 / 09



The compliances with these requirements are stated in the following test reports:

(1) EN IEC 61000-6-1: 2019; EN IEC 61000-6-2: 2019; EN 61000-6-3: 2007+A1:2011+AC2012; EN IEC 61000-6-4: 2019: Test Report no.BL-DG2190260-402, issued by Dongguan BALUN Technology Co., Ltd. on Oct.18, 2021. CNAS L14701

(2) IEC/EN 62109-1: 2010 : Report No. BL-DG2180298-B01 and IEC/EN 62109-1: 2011 : Report No. BL-DG2180298-B02 , issued by Dongguan BALUN Testing Technology Co., Ltd. on Oct.26, 2021. CNAS L14701

<b>EN 50438: 2013– Requirements for micro-generating plants to be connected in parallel with public low-voltage distribution networks</b>				
<b>REPORT SECTION</b>	<b>STANDARD SECTION</b>	<b>CHAPTER OF THE STANDARD</b>	<b>Plant category</b>	<b>Result</b>
4.6.1	Greece and Turkey	Requirements on voltage and frequency protection for default protection interface requirements according to EN 50549-1:2019	--	N/A
4.6.2	A.13 IE – Ireland	Requirements on voltage and frequency protection	--	P
4.6.3	A.16 NL – The Netherlands	Requirements on voltage and frequency protection	--	P
4.6.4	A.18 PL – Poland	Requirements on voltage and frequency protection	--	P

## 4. TEST RESULTS

### 4.1. NORMAL OPERATING RANGE

#### 4.1.1. Operating frequency range

The test has been done according to the clause 4.4.2 of the standard, the requirement is as follows:

Table 1 — Minimum time periods for operation in underfrequency and overfrequency situations

Frequency Range	Time period for operation Minimum requirement	Time period for operation stringent requirement
47,0 Hz – 47,5 Hz	not required	20 s
47,5 Hz – 48,5 Hz	30 min <sup>a</sup>	90 min
48,5 Hz – 49,0 Hz	30 min <sup>a</sup>	90 min <sup>a</sup>
49,0 Hz – 51,0 Hz	Unlimited	Unlimited
51,0 Hz – 51,5 Hz	30 min <sup>a</sup>	90 min
51,5 Hz – 52,0 Hz	not required	15 min

<sup>a</sup> Respecting the legal framework, it is possible that longer time periods are required by the responsible party in some synchronous areas.

“Time period for operation, Minimum requirement” (first column of the table) has been considered for this test.

In order to verify this function, parameter settings as in the following table have been considered to perform the test. Time requirements considered are the “minimum requirement” according to Table 1 of the standard:

Steps	f (Hz) Setting	Time requirement	f Measured (Hz)	Time Measured (Min)	Power measured (p.u.)
1	47.00	Not required	47.00	0.95	1.001
2	47.50	>30 min	47.50	99.97	1.000
3	48.50	>30 min	48.50	99.97	1.001
4	52.00	Not required	52.00	19.97	1.001
5	50.00	Unlimited	50.00	1.97	1.001
6	51.50	>30 min	51.50	99.97	1.001
7	52.00	Not required	52.00	18.68	1.001

Operating frequency range

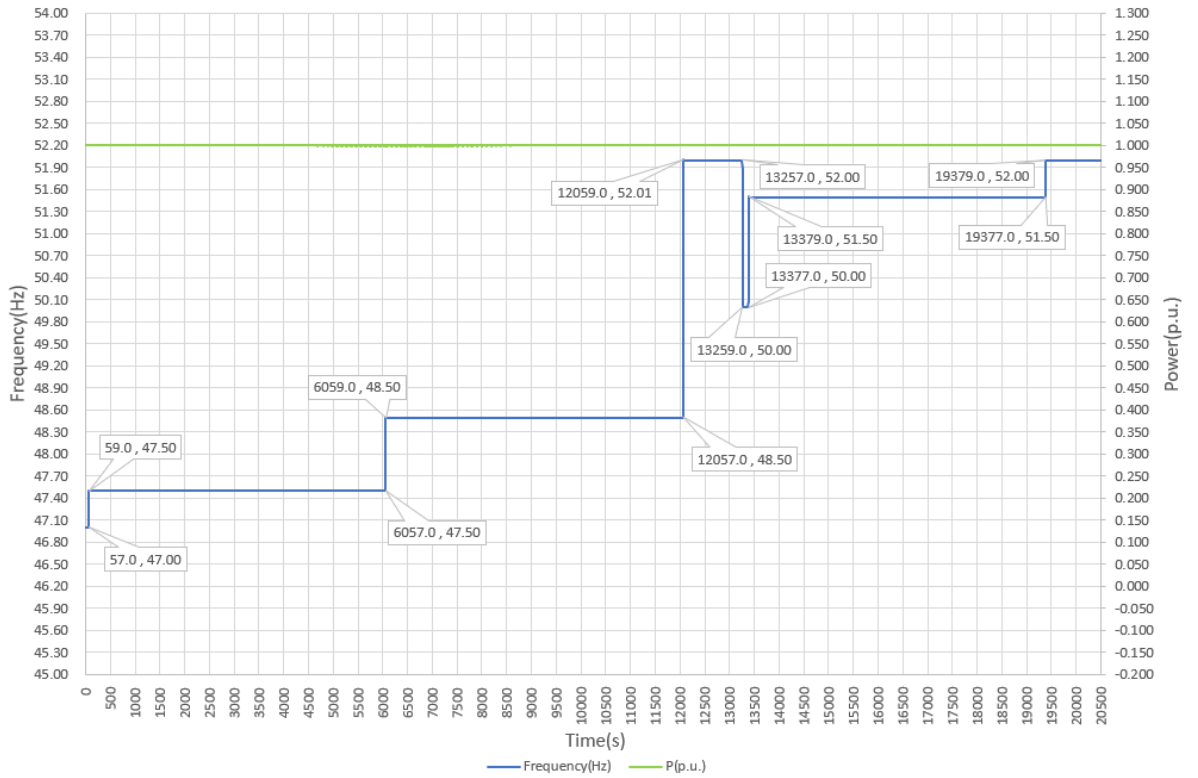

**4.1.2. Minimal requirement for active power delivery at underfrequency**

The test has been done according to the clause 4.4.3 of the standard, the requirement is as follows:

A generating plant shall be resilient to the reduction of frequency at the point of connection while reducing the maximum active power as little as possible.

The admissible active power reduction due to underfrequency is limited by the full line in Figure 5 of the standard and is characterized by a maximum allowed reduction rate of 10 % of Pmax per 1 Hz for frequencies below 49.5 Hz.

It is possible that a more stringent power reduction characteristic is required by the responsible party. Nevertheless this requirement is expected to be limited to an admissible active power reduction represented by the dotted line in Figure 5 which is characterised by a reduction rate of 2 % of the maximum power Pmax per 1 Hz for frequencies below 49 Hz.

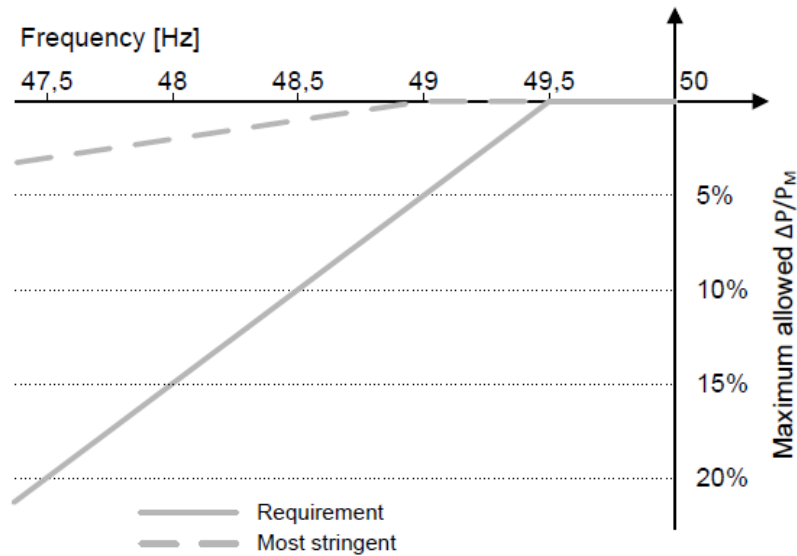
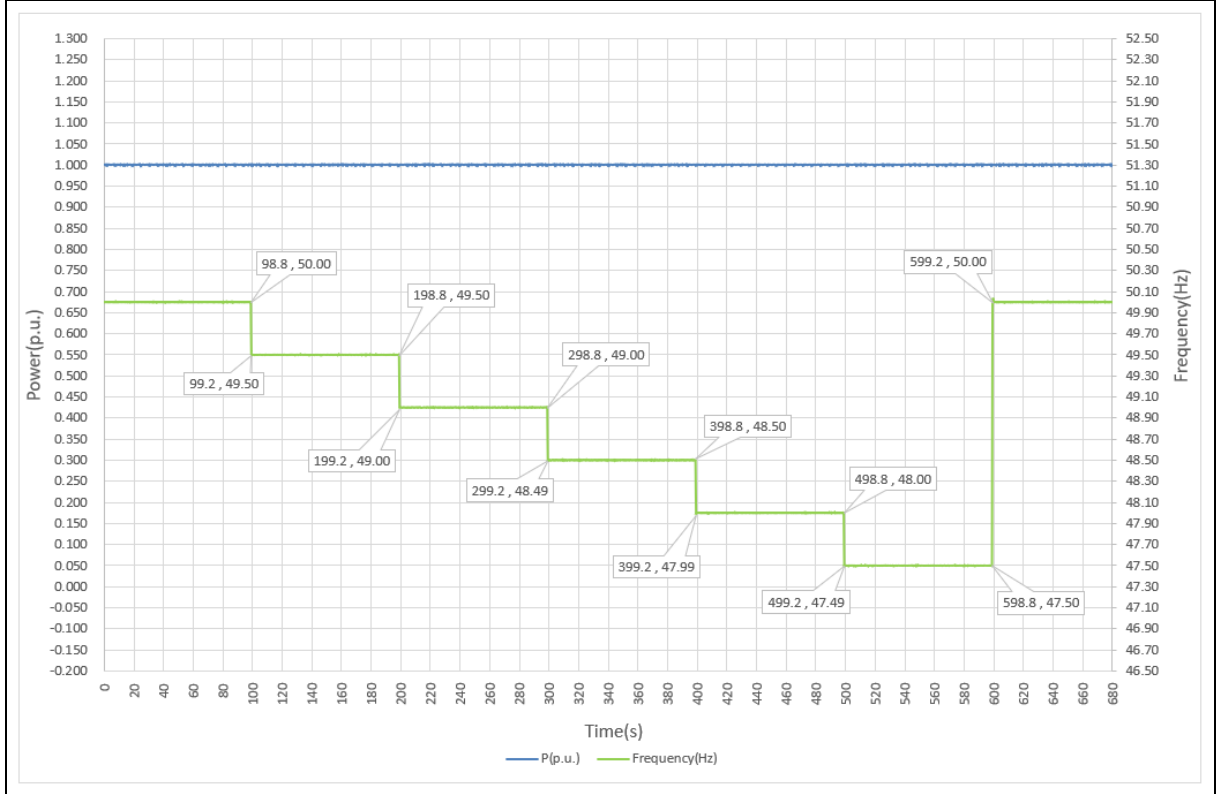

Figure 5 — Maximum allowable power reduction in case of underfrequency

As defined by manufacturer, the power will not reduce when the frequency is below 49.5 Hz.

Step	f (Hz)	f meas. (Hz)	T (s)	T meas. (s)	P desired (p.u.)	P meas. (p.u.)	P deviation (p.u.)
1	50.00 ± 0.05	50.00	>60	98.8	1.000	1.001	+0.001
2	49.50 ± 0.05	49.50	>60	99.6	1.000	1.001	+0.001
3	49.00 ± 0.05	49.00	>60	99.6	1.000	1.001	+0.001
4	48.50 ± 0.05	48.50	>60	99.6	1.000	1.001	+0.001
5	48.00 ± 0.05	48.00	>60	99.6	1.000	1.001	+0.001
6	47.50 ± 0.05	47.50	>60	99.6	1.000	1.001	+0.001
7	50.00 ± 0.05	50.00	>60	80.8	1.000	1.001	+0.001

Active power delivery at underfrequency



### 4.1.3. Continuous operating voltage range

The test has been done according to the clause 4.4.4 of the standard, the requirement is as follows:

The generating plant shall be capable of operating continuously when the voltage at the point of connection stays within the range of 85%Un to 110%Un.

In order to verify this function, the parameter setting is as follows to perform the test:

Step	V desired (p.u.)	P desired (p.u.)	V meas. (p.u.)	P meas. (p.u.)	Time meas.(s)
1	1.000	1.000	1.002	1.000	180.2
2	0.850	1.000	0.851	0.992	180.4
3	1.000	1.000	1.002	1.000	179.2
4	1.100	1.000	1.100	1.000	179.0

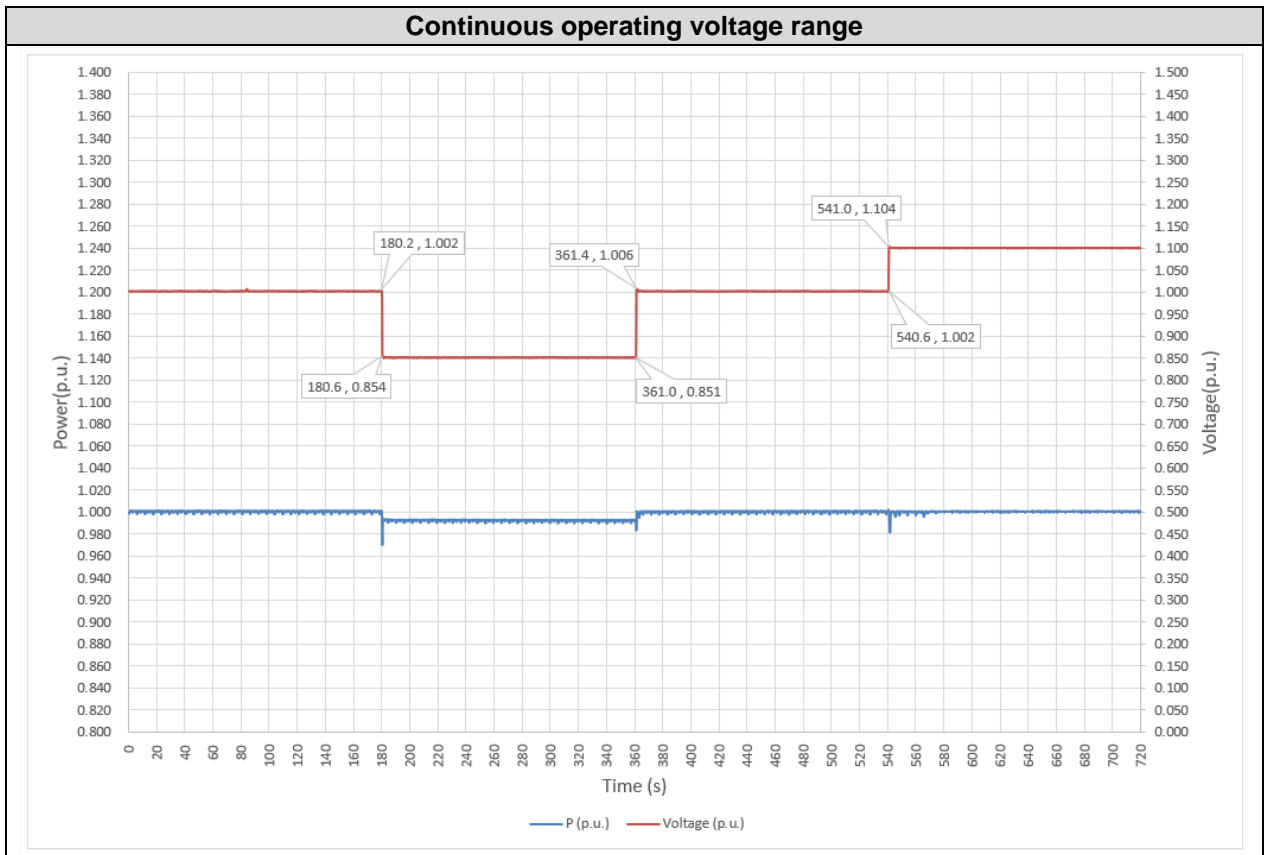

**4.2. IMMUNITY TO DISTURBANCES**

**4.2.1. Rate of change of frequency (ROCOF) immunity**

The test has been done according to the clause 4.5.2 of the standard, the requirement is as follows:

- **Non-synchronous generating technology: at least 2 Hz/s**

The ROCOF immunity is defined with a sliding measurement window of 200 ms as follows:

Steps	f (Hz)	ROCOF requirement (Hz/s)	Step time	Measured frequency (Hz)	Measured step change time (s)	ROCOF meas. (Hz/s)	Disconnection
1	50.00 ± 0.05	N/A	>10 s	50.00	--	--	No
2	52.00 ± 0.05	>2	>10 s	52.00	0.8	+2.5	No
3	50.00 ± 0.05	>2	>10 s	50.00	0.8	-2.5	No
4	48.00 ± 0.05	>2	>10 s	48.00	0.8	-2.5	No
5	50.00 ± 0.05	>2	>10 s	50.00	0.8	+2.5	No

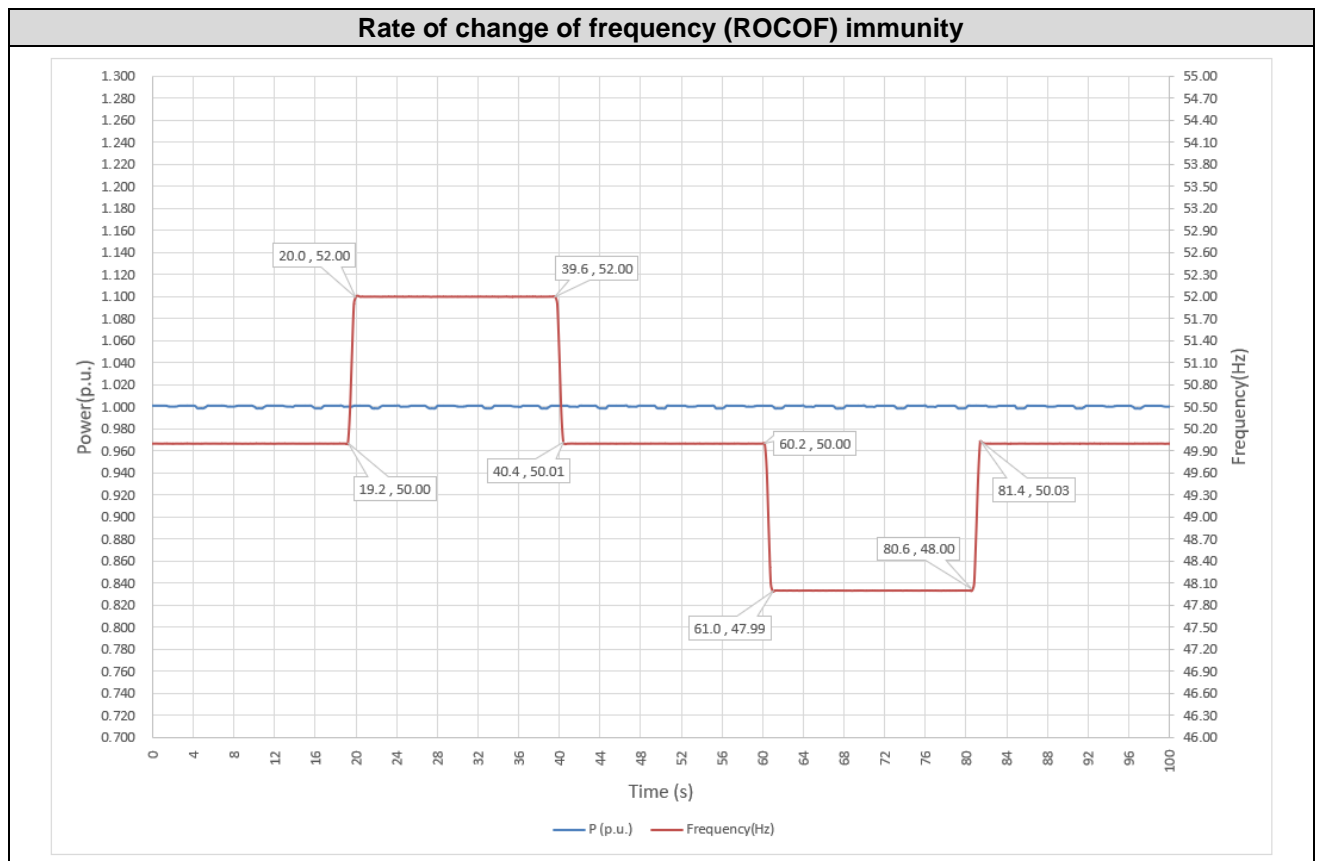

**4.2.2. Under-voltage ride through (UVRT)**

The requirements are defined in the clause 4.5.3 of the standard.  
The test uses the most stringent line in the following figure.

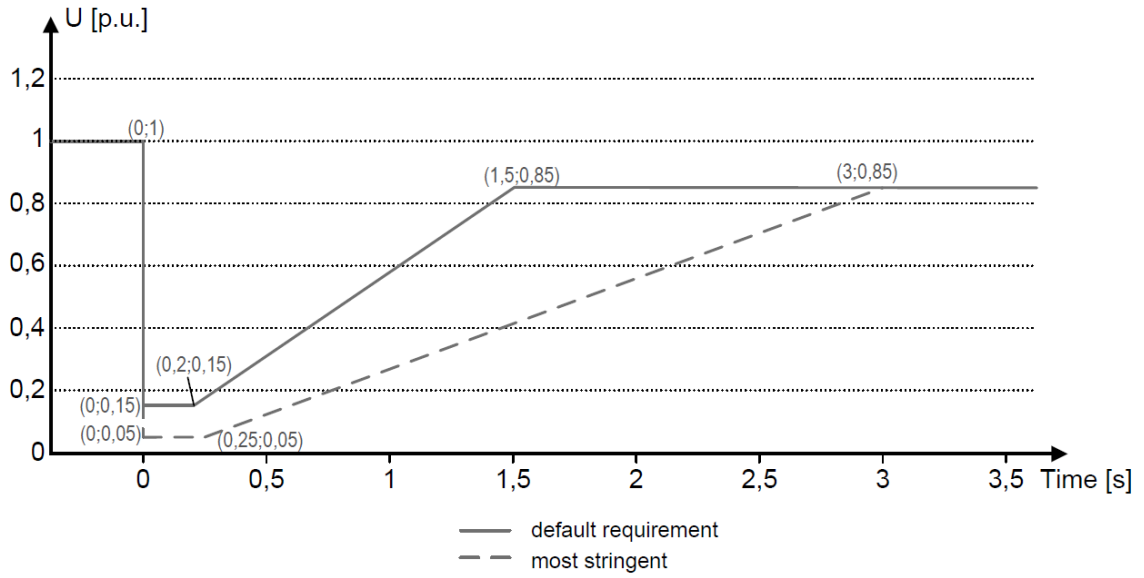



**4.2.1.1. No load Test**

It is not specified in the reference standard, but following tolerances have been applied. Tolerances for drop depth and duration during no-load tests shall not exceed the values shown in the next figure:

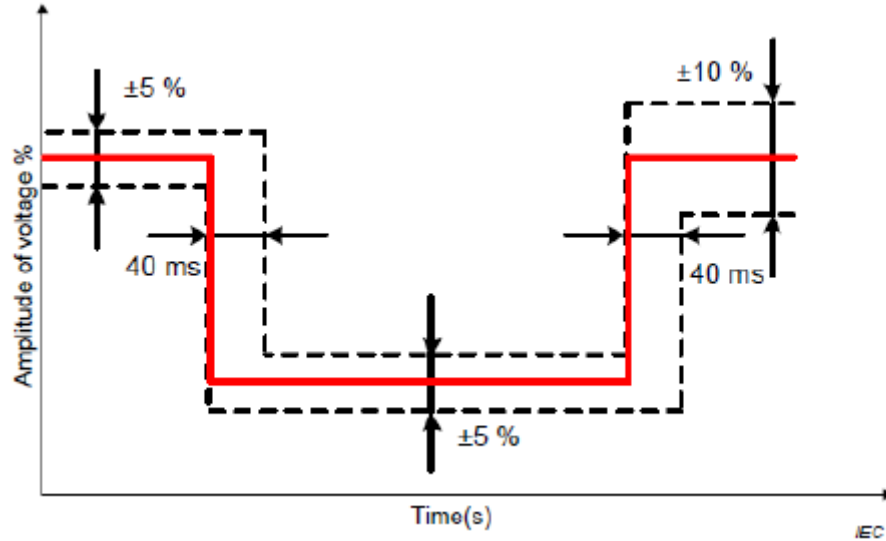

The tolerance for voltage magnitude is  $\pm 5\%U_n$  for the period before and during the voltage drop. The tolerance for voltage magnitude is  $\pm 10\%U_n$  during the period after voltage is recovered. The tolerance range for both drop duration and rise time prefers 40 ms.

Test results of different no-load cases performed are offered below:

No Load								
Phase type	Residual voltage desired (%Un)	Voltage before fault (%Un)	Voltage drop time (ms)	Residual voltage Measured (%Un)	Dip time desired (ms)	Dip time measured (ms)	Power recovery time (ms)	Voltage after recovery (%Un)
1 ph	0.0-5.0	100.0	18	4.0	$\geq 250$	261	--	100.0
2 ph		99.9	20	4.0		260	--	99.9
3 ph		100.0	20	4.0		260	--	100.0
1 ph	25.0	100.0	17	25.0	$\geq 938$	982	--	100.0
2 ph		100.0	20	25.0		980	--	100.0
3 ph		100.0	19	25.0		980	--	100.0
1 ph	50.0	100.0	17	50.1	$\geq 1797$	1832	--	100.0
2 ph		100.0	20	50.1		1831	--	100.0
3 ph		100.0	20	50.1		1830	--	100.0
1 ph	75.0	100.0	17	75.1	$\geq 2656$	2783	--	100.0
2 ph		100.0	19	75.1		2781	--	99.9
3 ph		100.0	20	75.1		2780	--	100.0

Test results are graphically represented in the following pages.

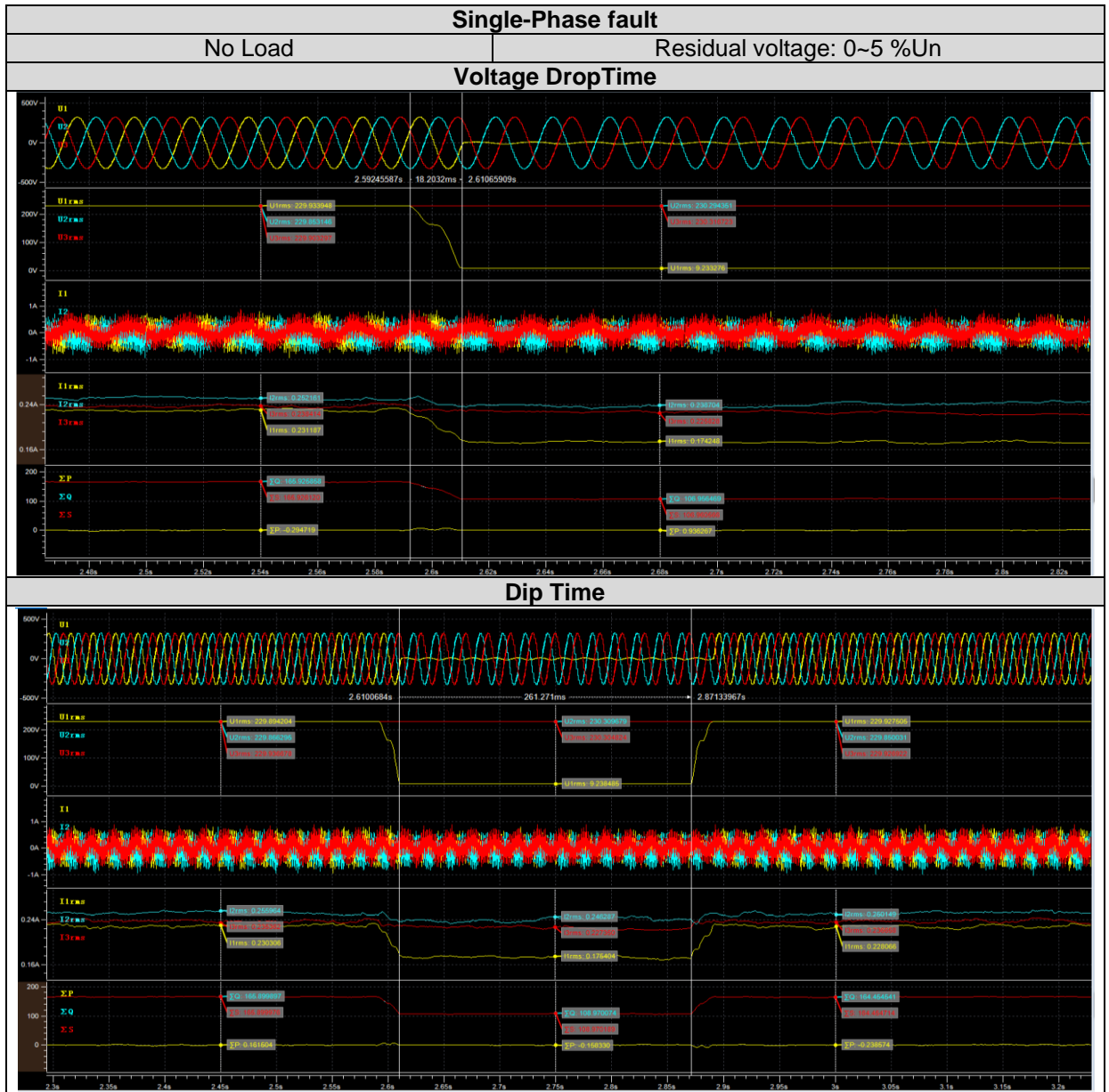

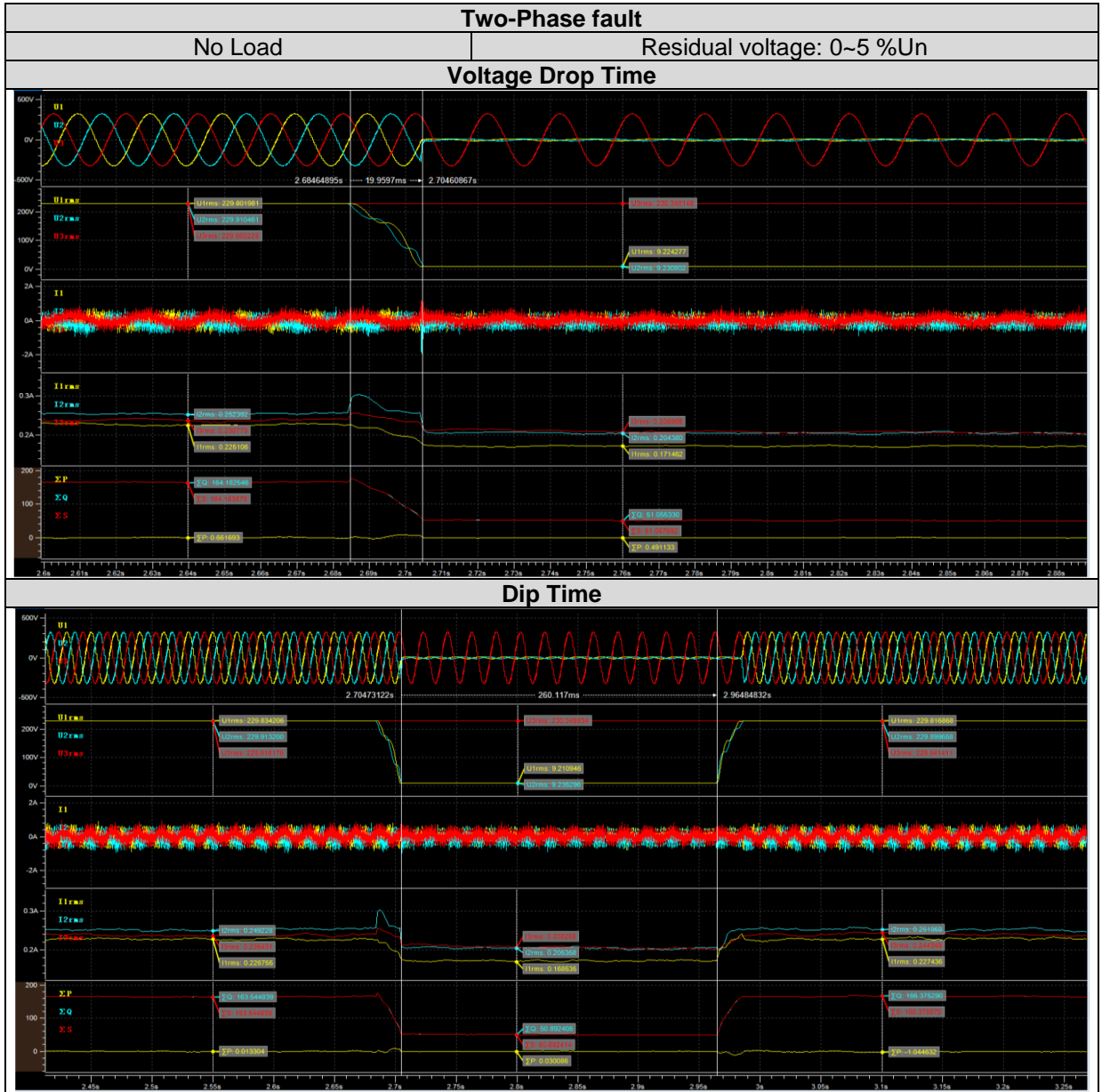

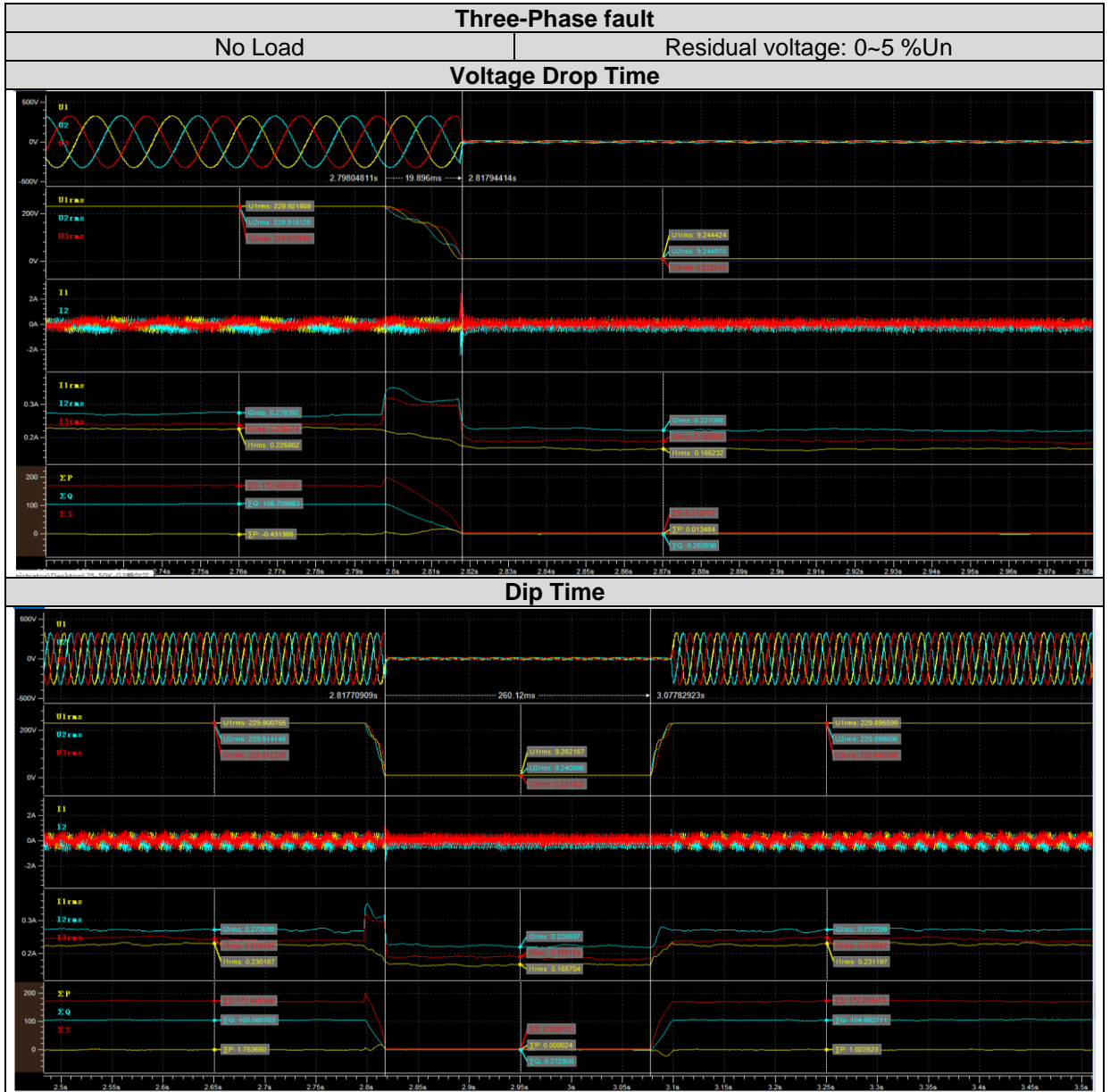

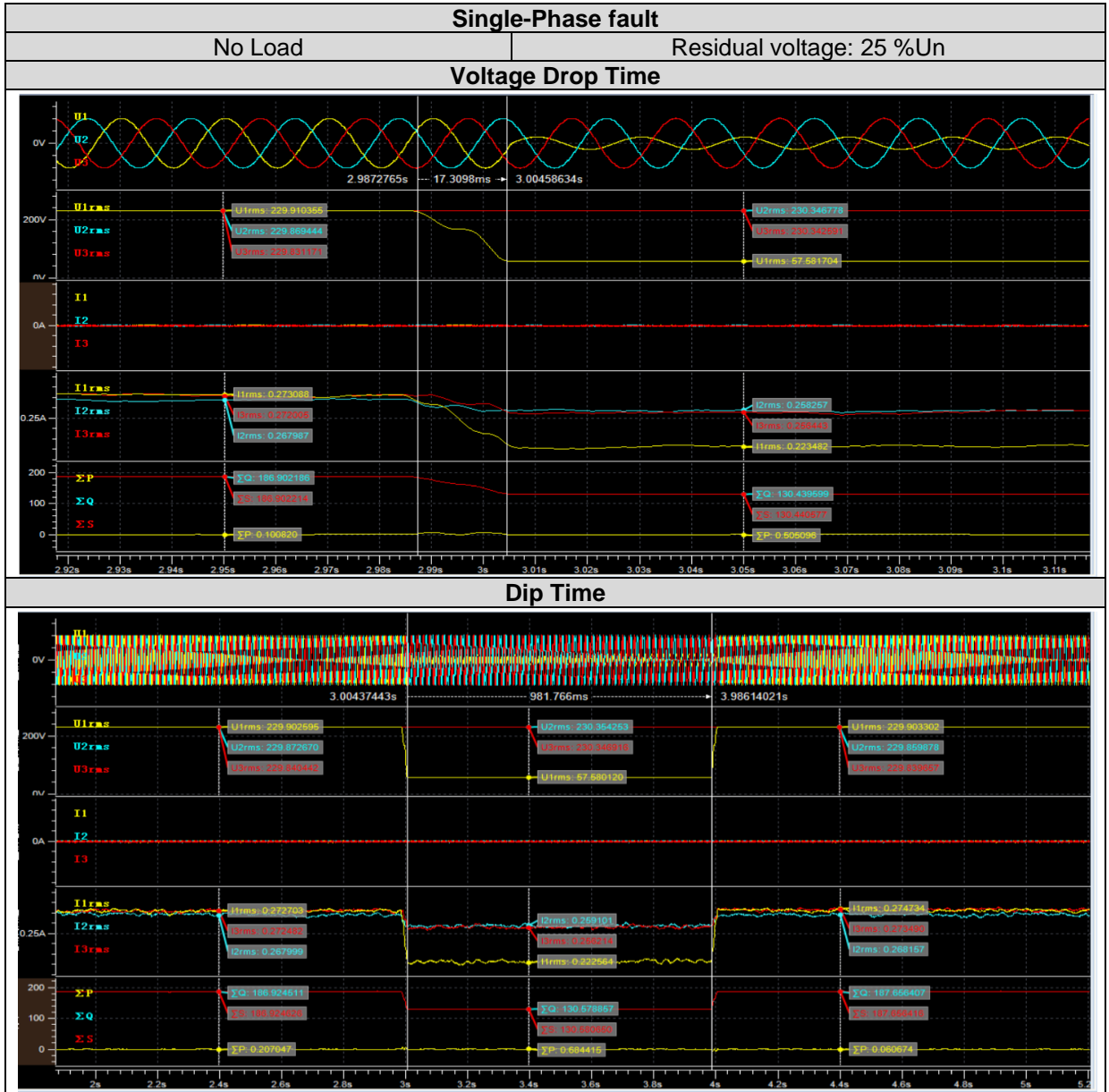

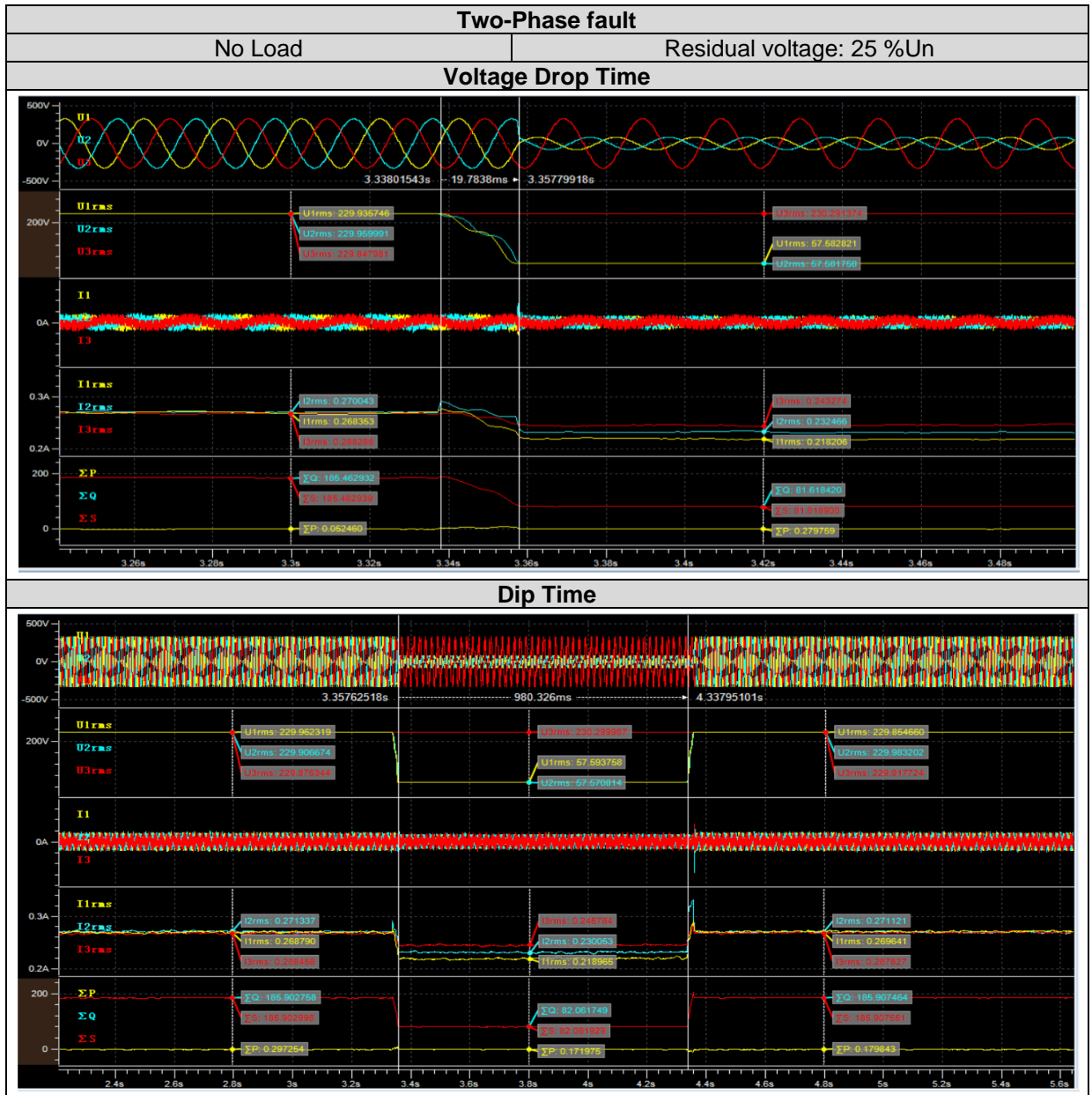

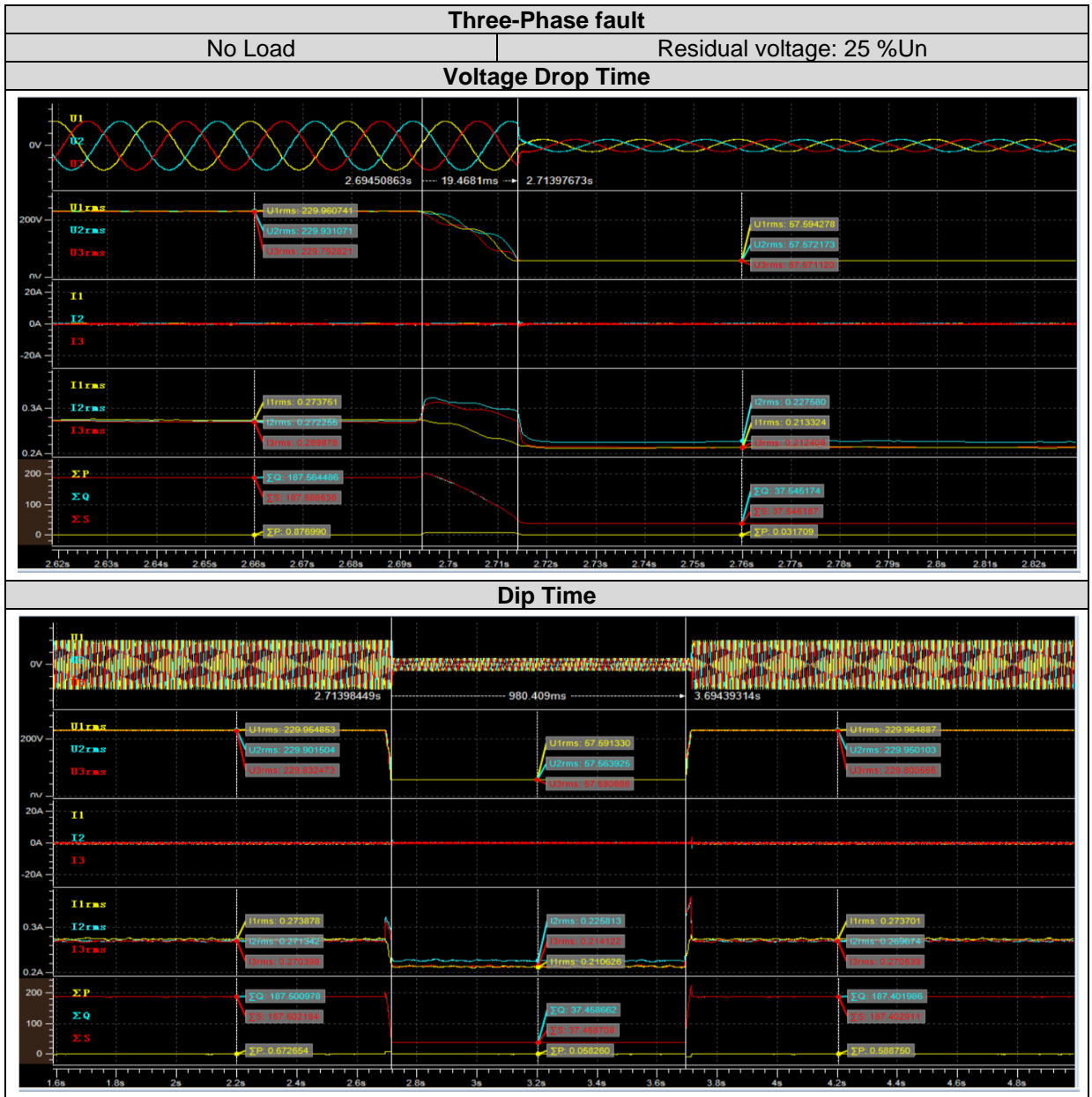

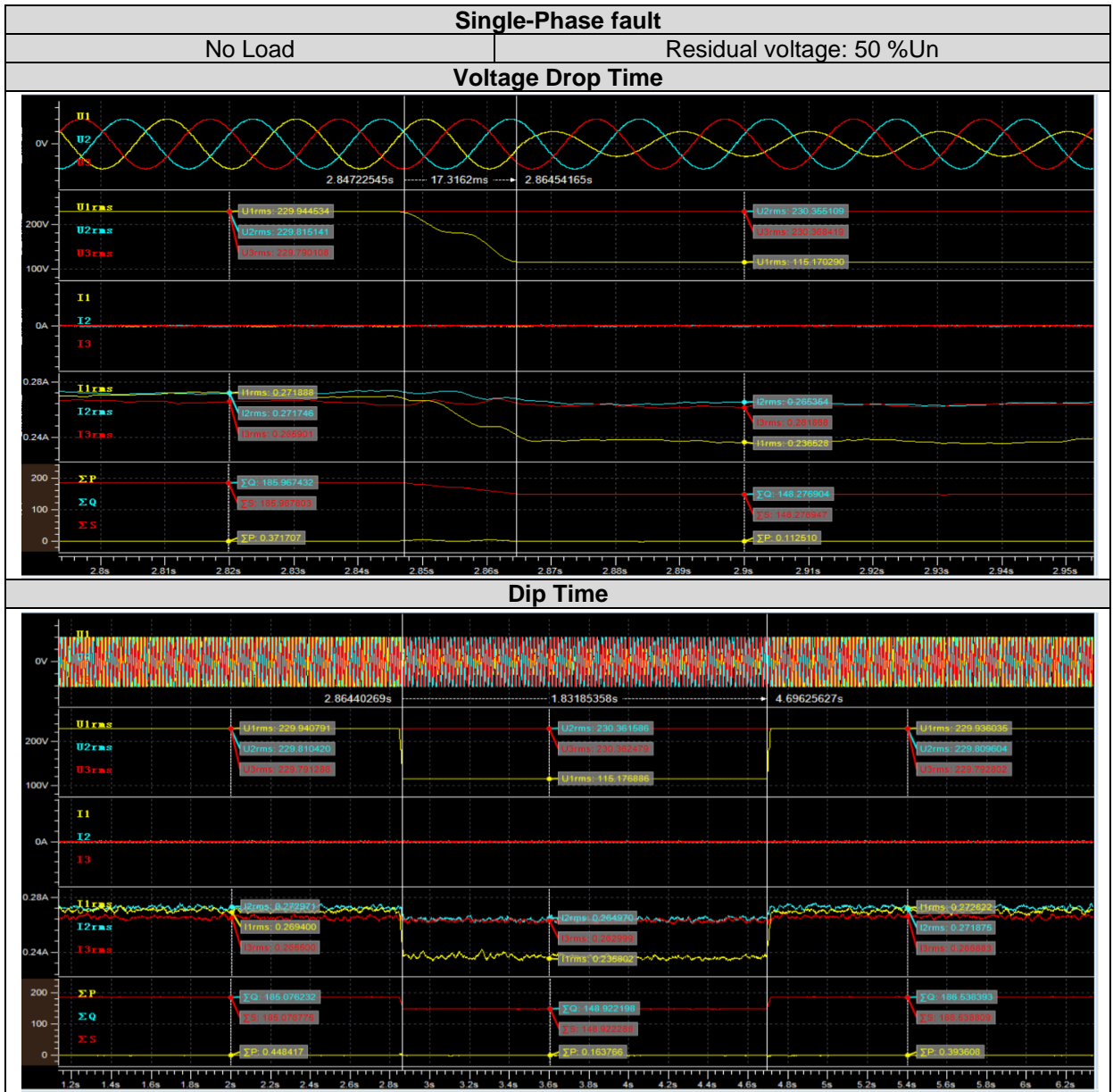



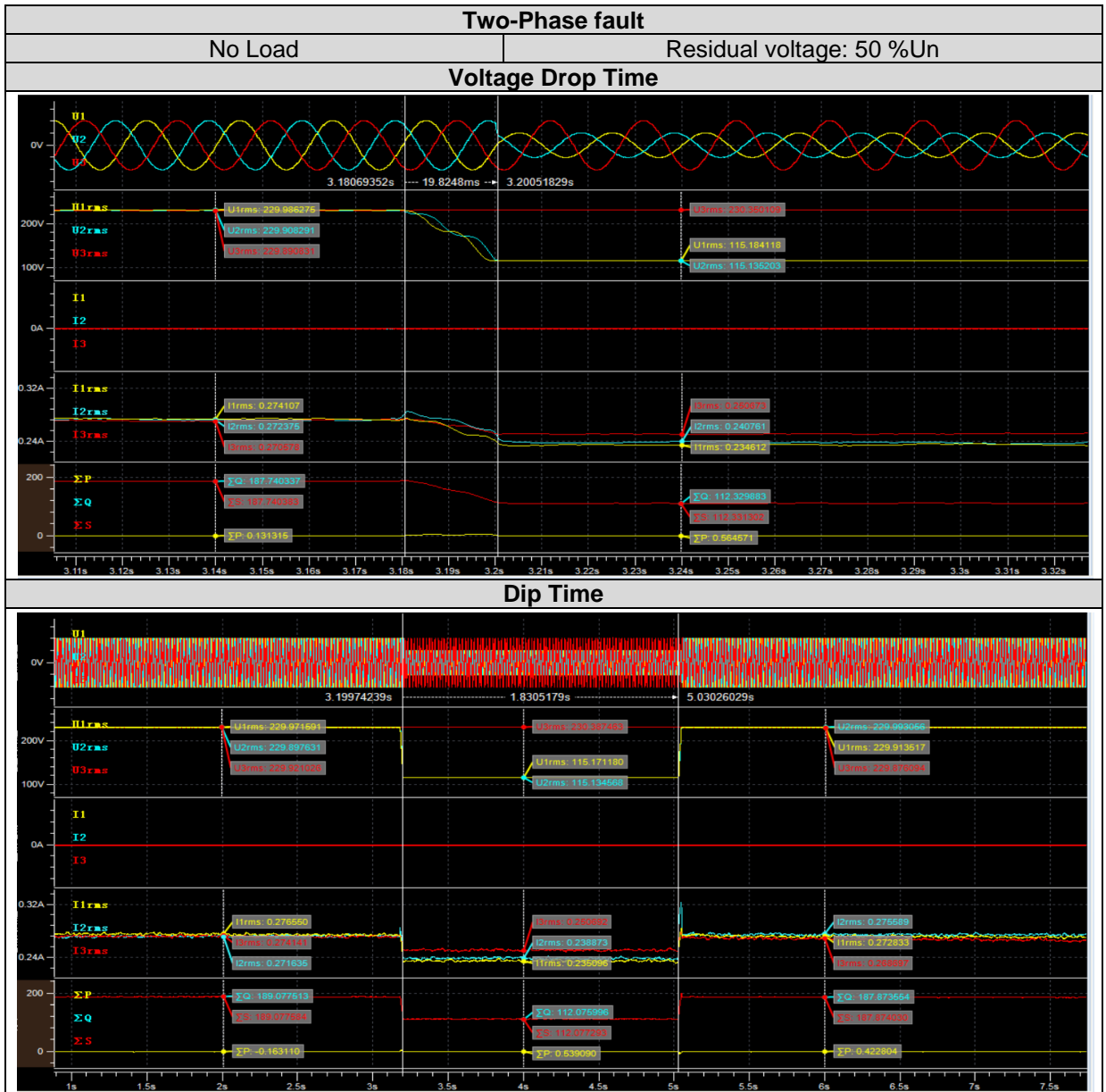

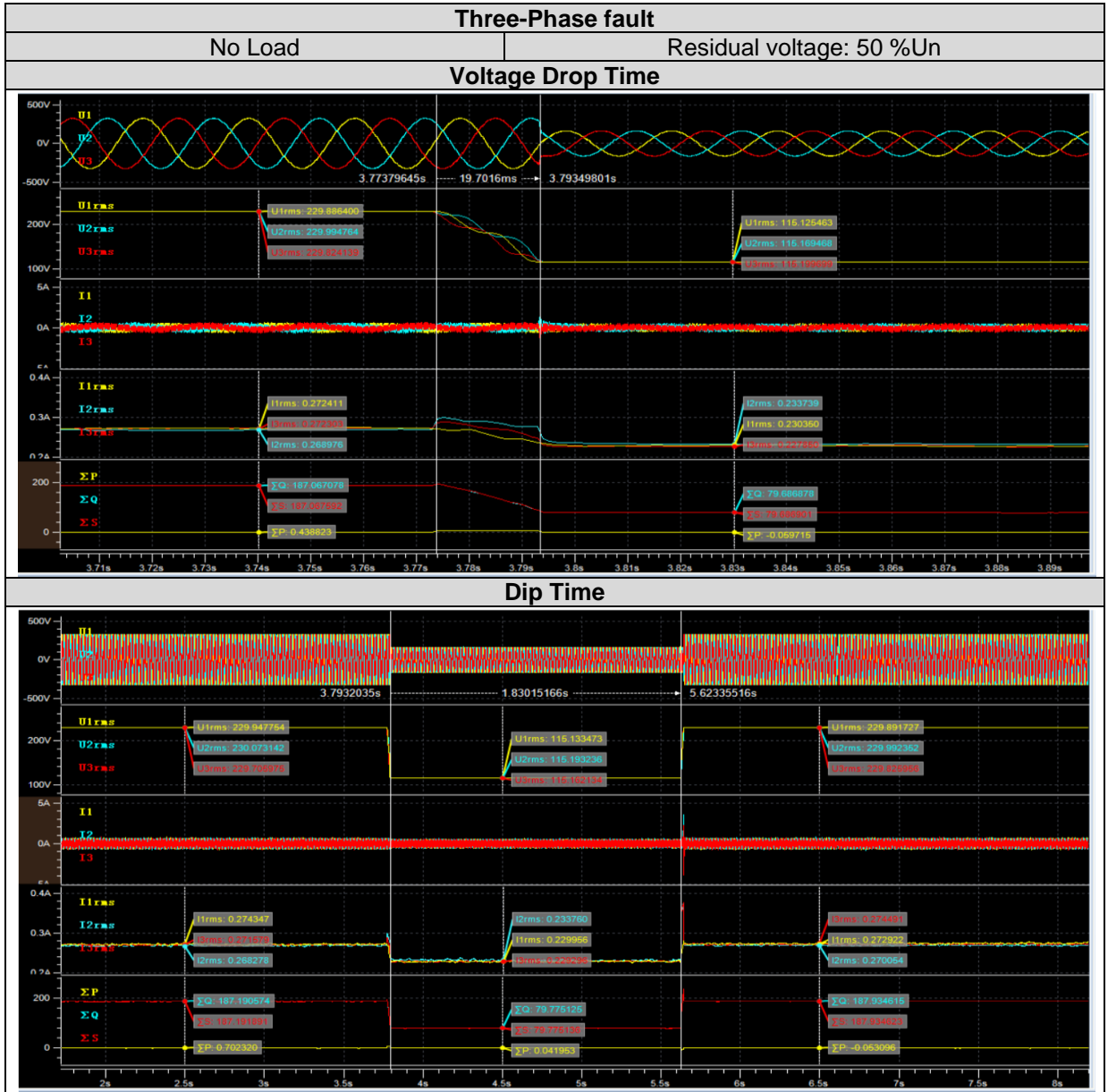

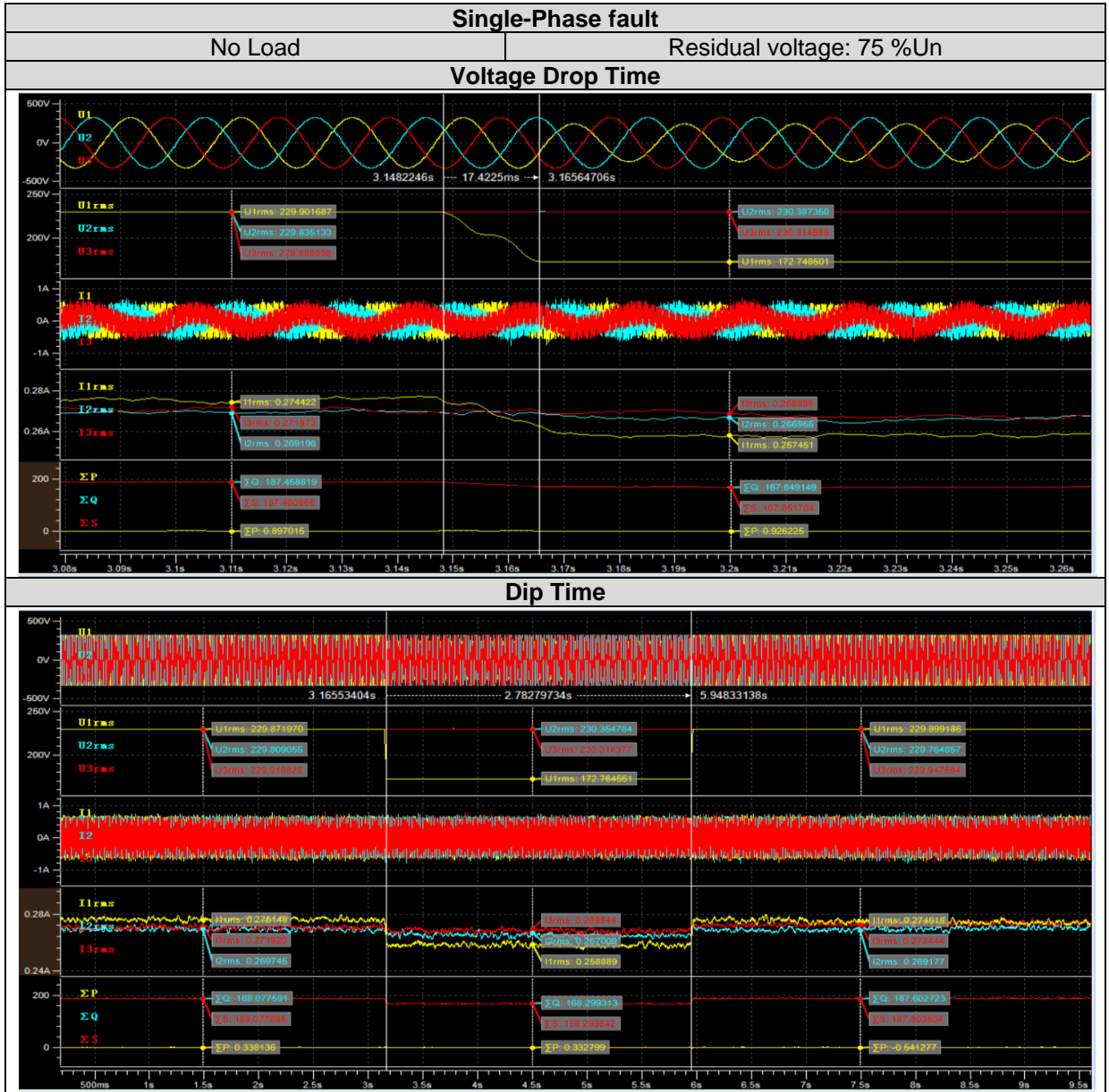

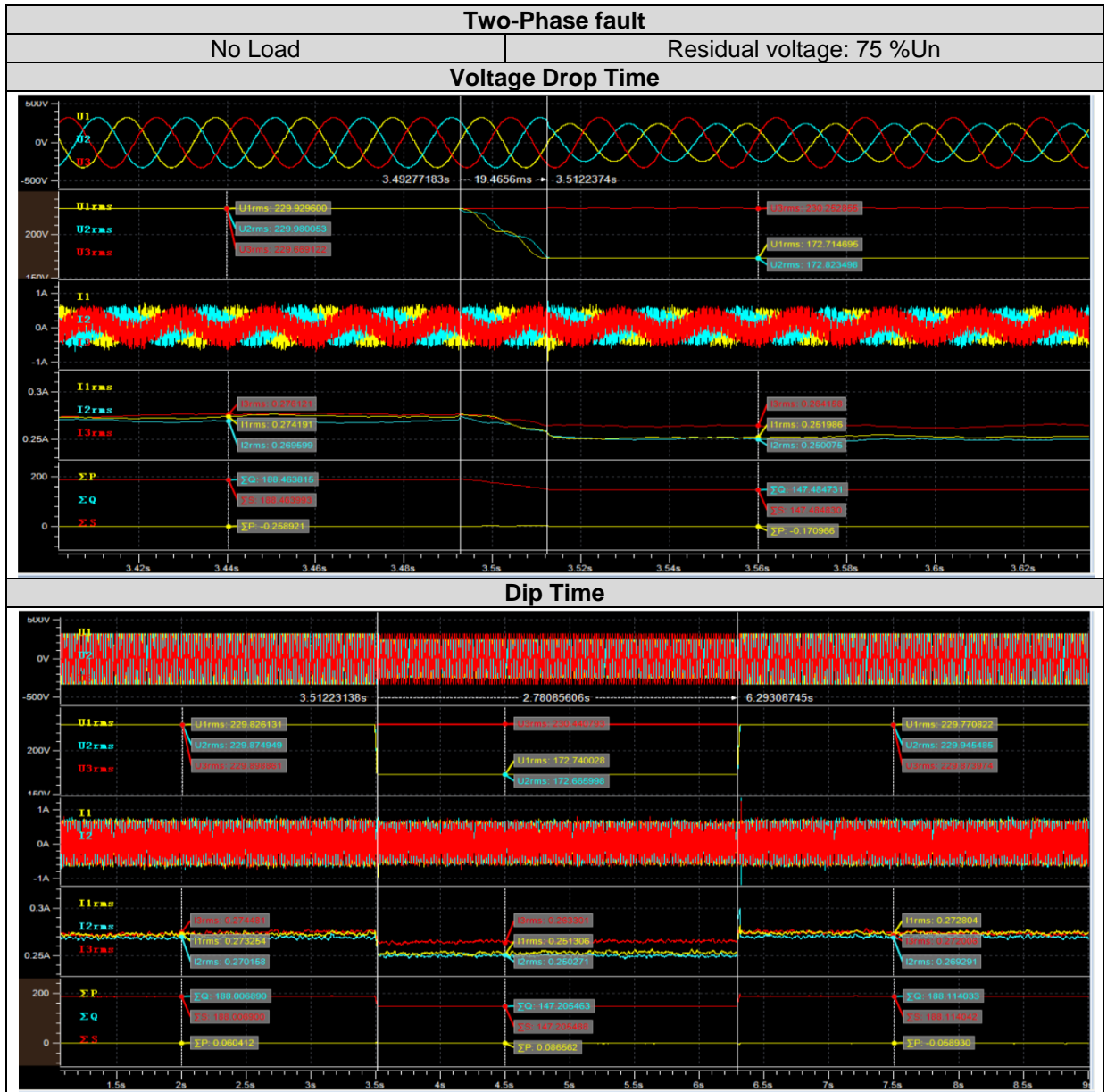

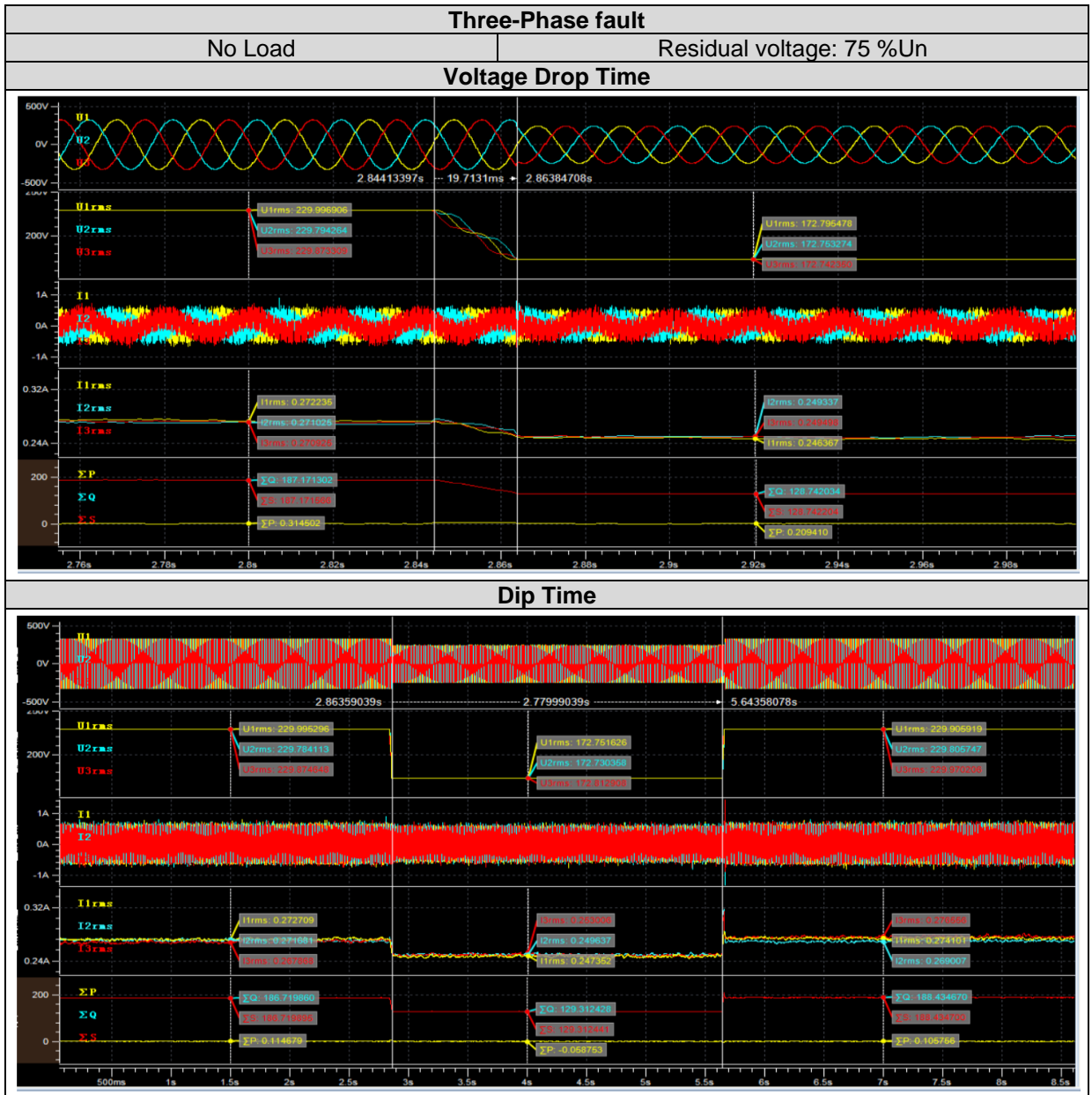

**4.2.1.2. Load Tests: Partial load (20 %Pn)**

Test results of different 20%Pn load cases performed are offered below:

20 %Pn Load								
Phase type	Residual voltage desired (%Un)	Voltage before fault (%Un)	Voltage drop time (ms)	Residual voltage Measured (%Un)	Dip time desired (ms)	Dip time measured (ms)	Power recovery time (ms)	Voltage after recovery (%Un)
1 ph	0.0-5.0	100.0	18	4.1	≥ 250	261	39	100.0
2 ph		100.0	20	4.1		261	35	100.1
3 ph		100.0	20	4.0		260	38	100.1
1 ph	25.0	100.0	17	25.0	≥ 938	982	31	100.2
2 ph		100.0	20	25.0		980	33	100.1
3 ph		100.0	20	25.1		979	33	100.1
1 ph	50.0	100.0	17	50.1	≥ 1797	1831	24	100.1
2 ph		100.0	20	50.1		1830	20	100.1
3 ph		100.0	19	50.1		1830	20	100.1
1 ph	75.0	99.9	17	75.1	≥ 2656	2782	34	100.1
2 ph		100.0	20	75.1		2780	32	100.1
3 ph		100.0	20	75.1		2780	32	100.1

Test results are graphically represented at following pages.

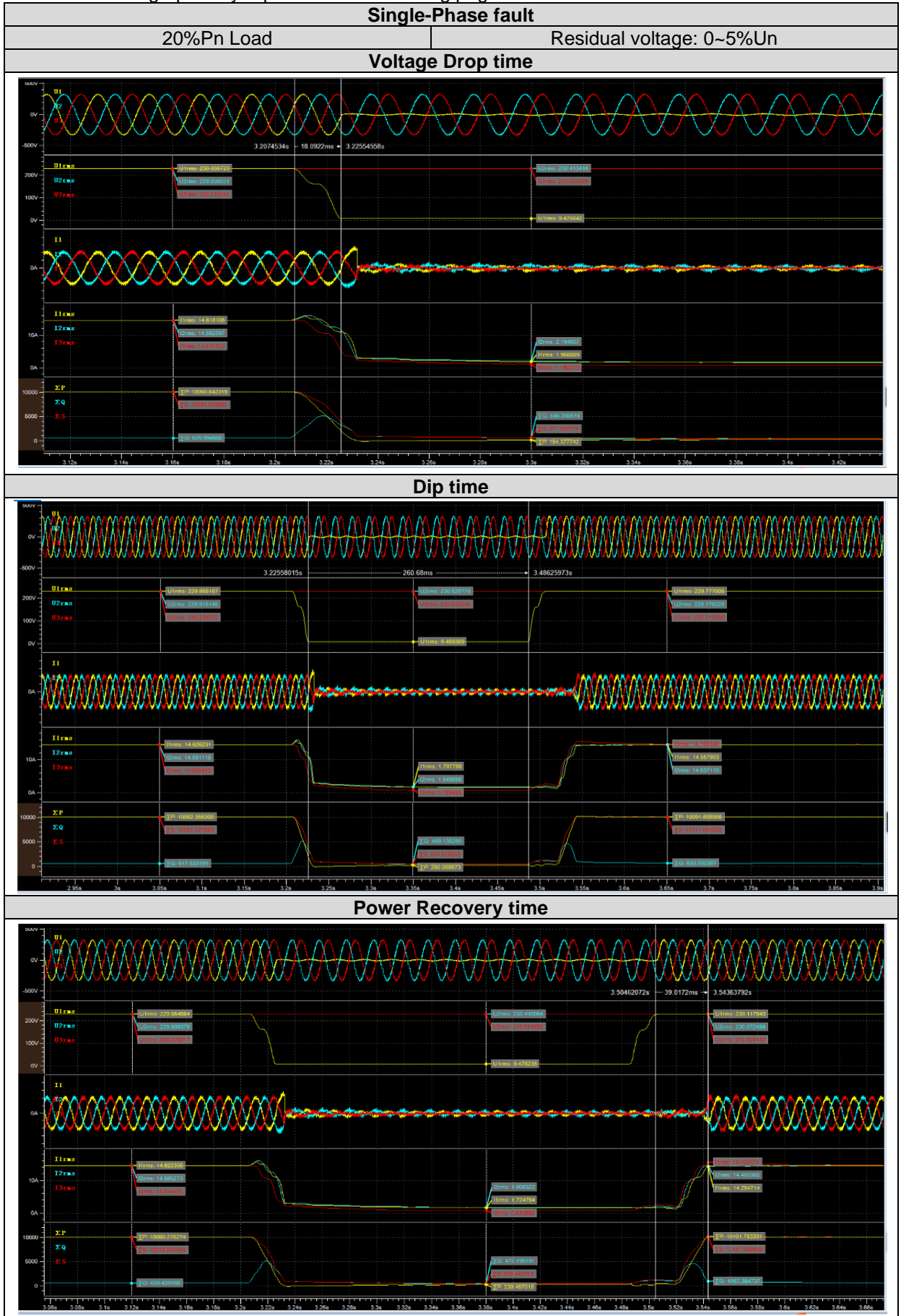

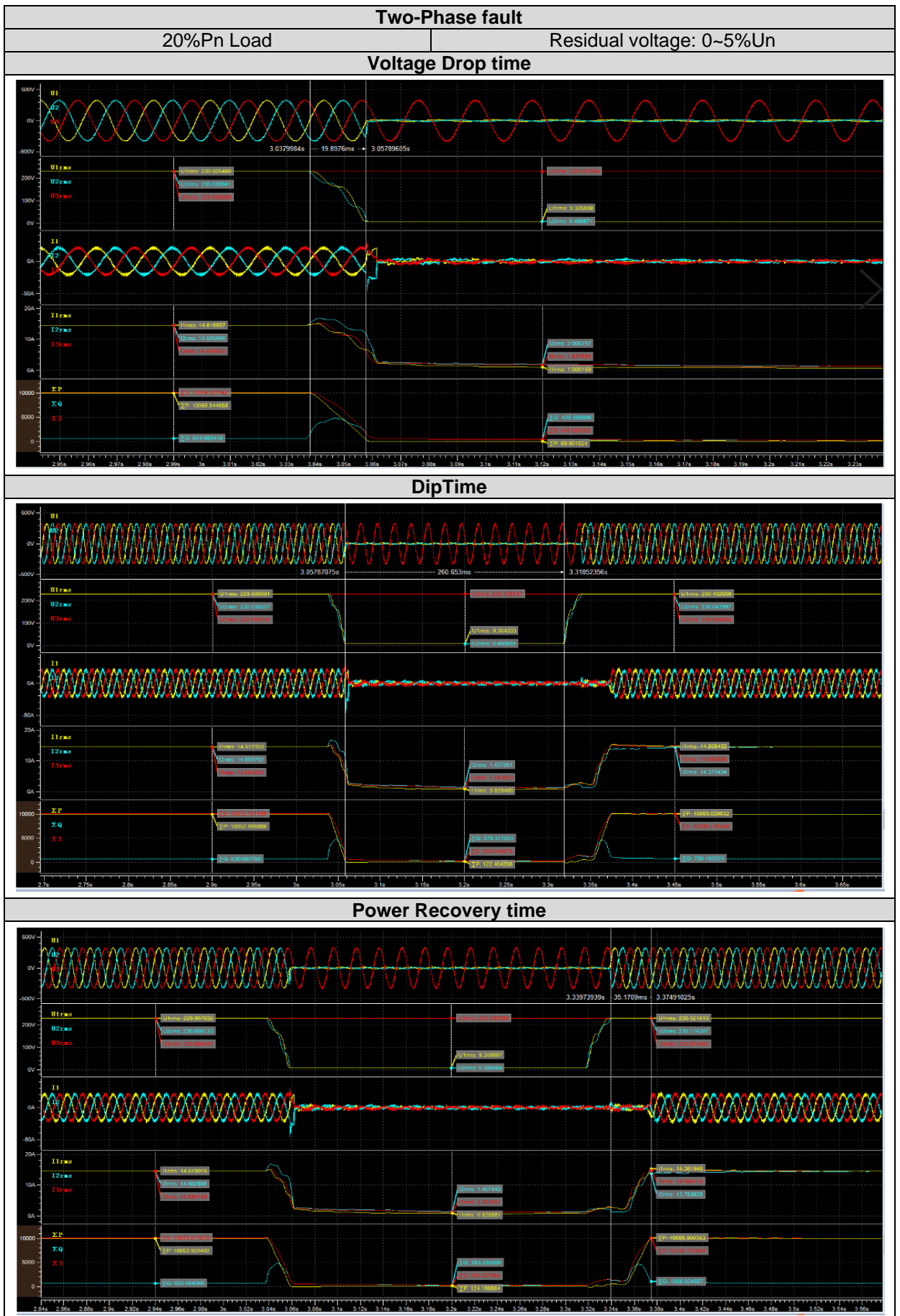



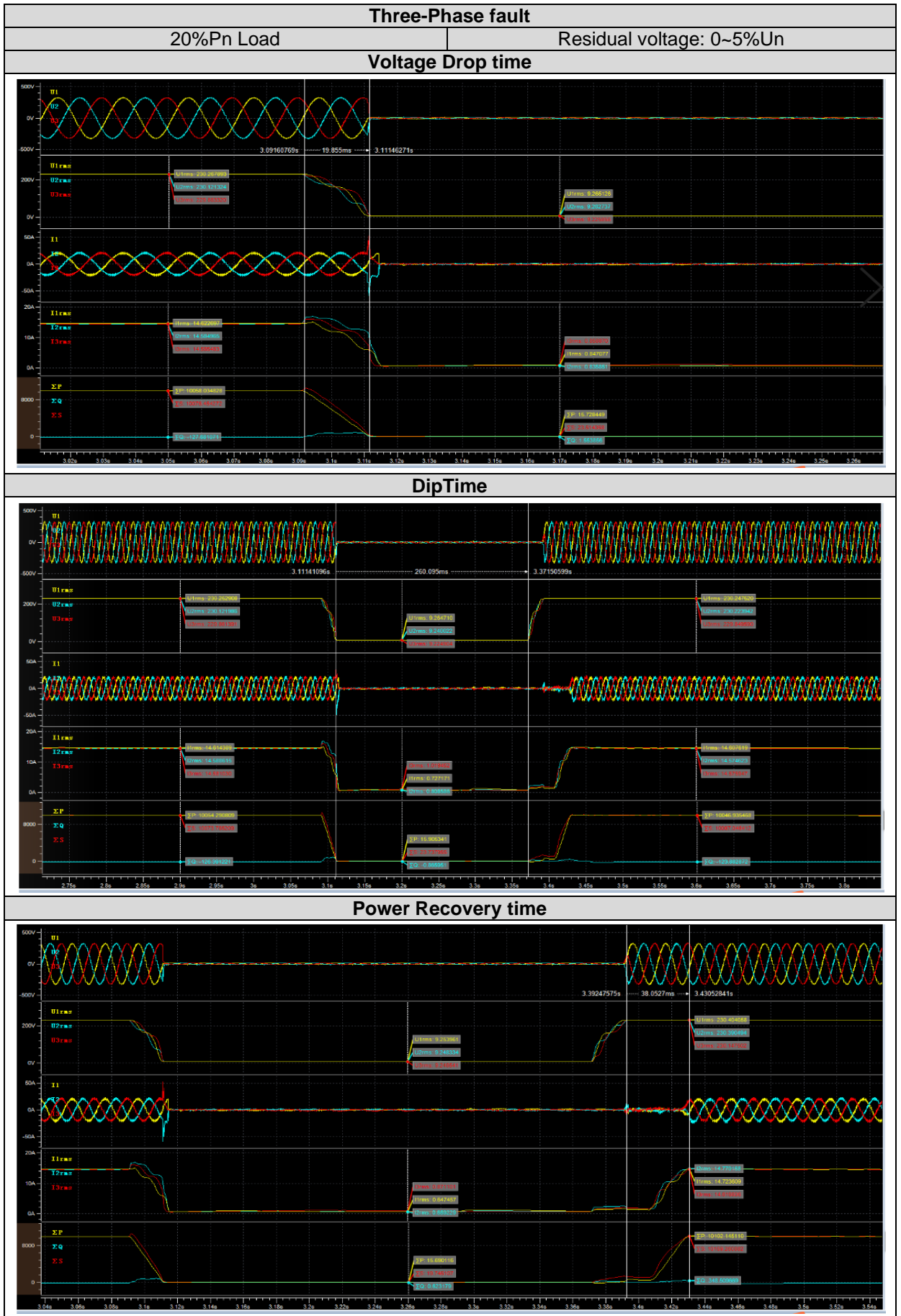

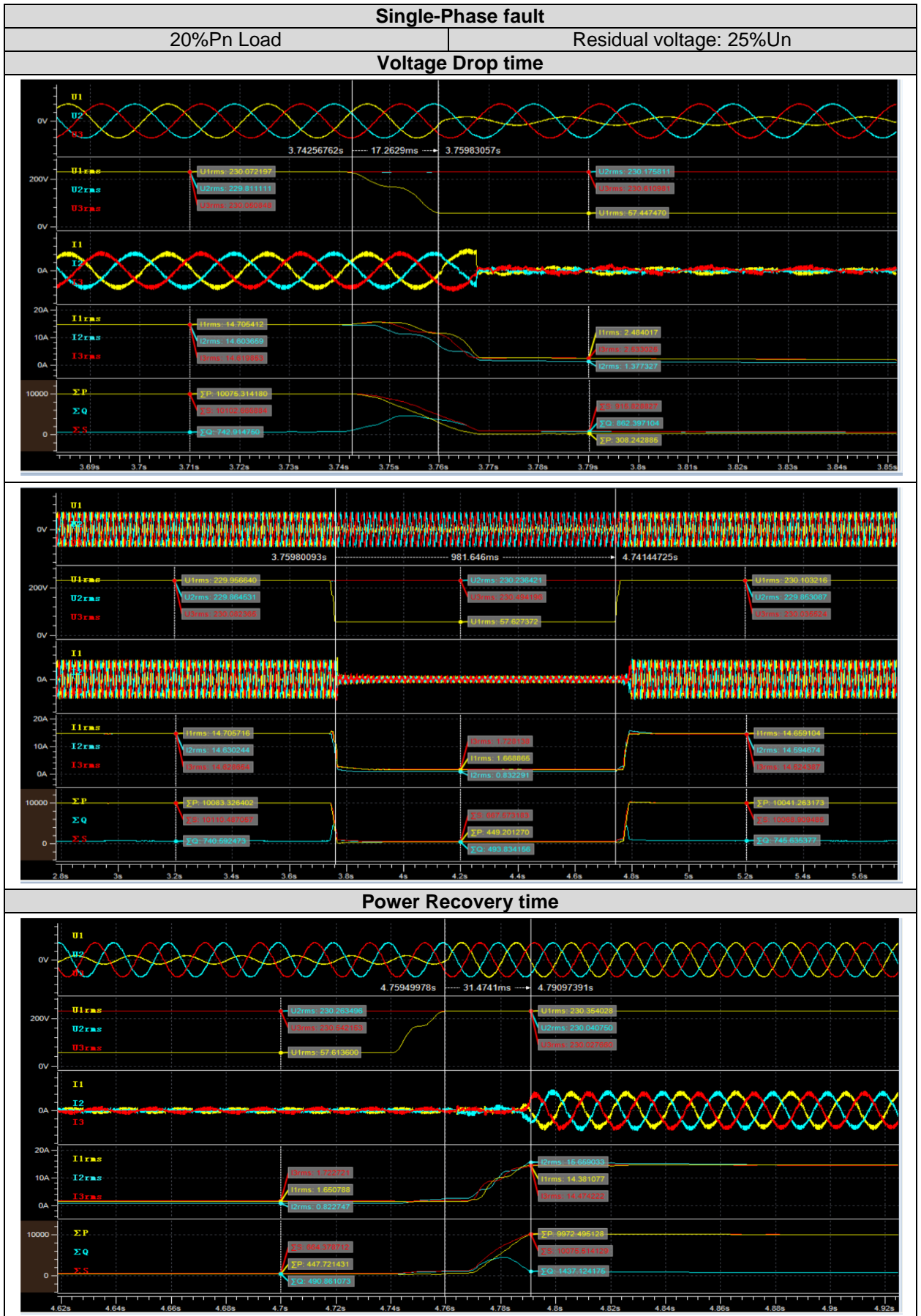

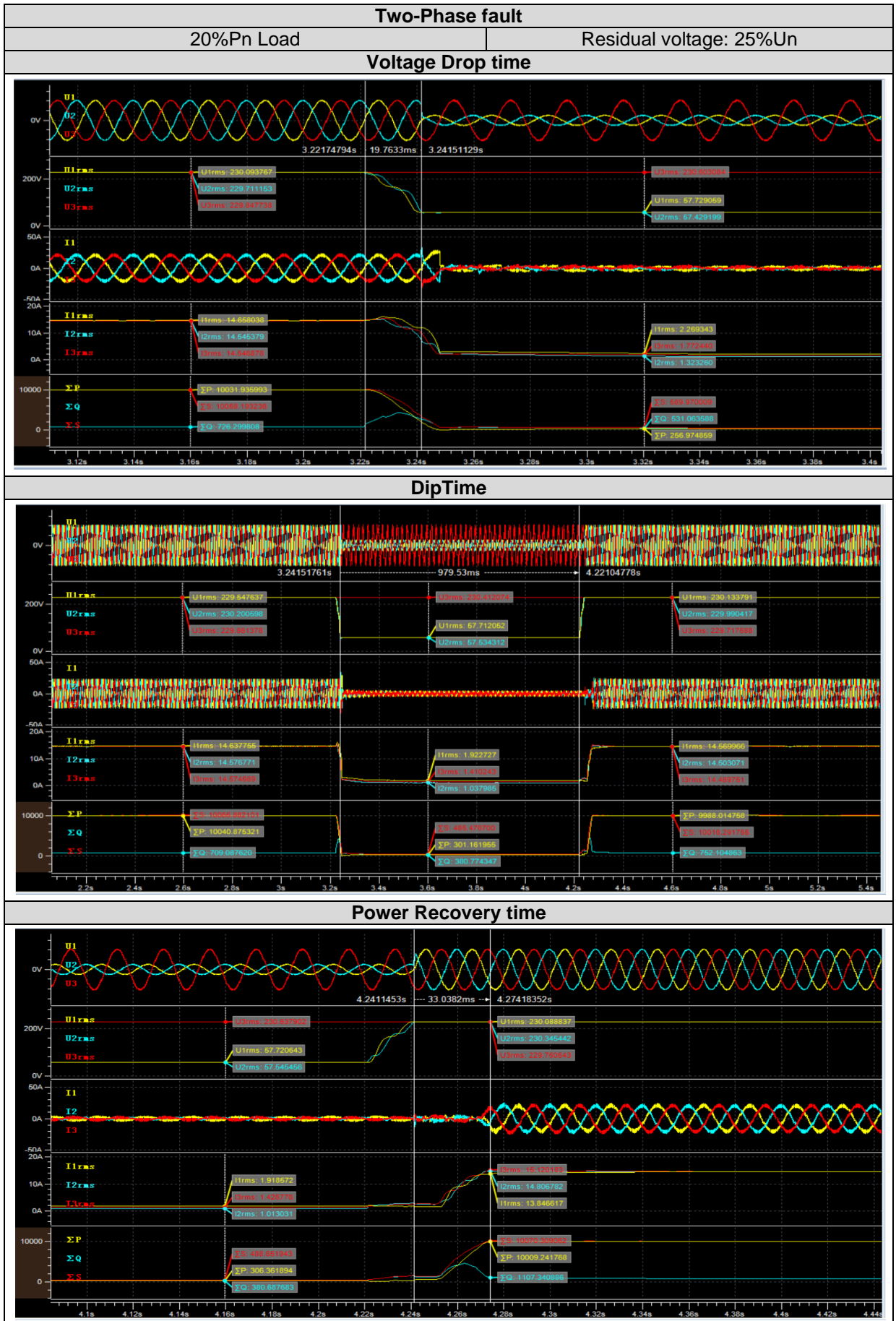

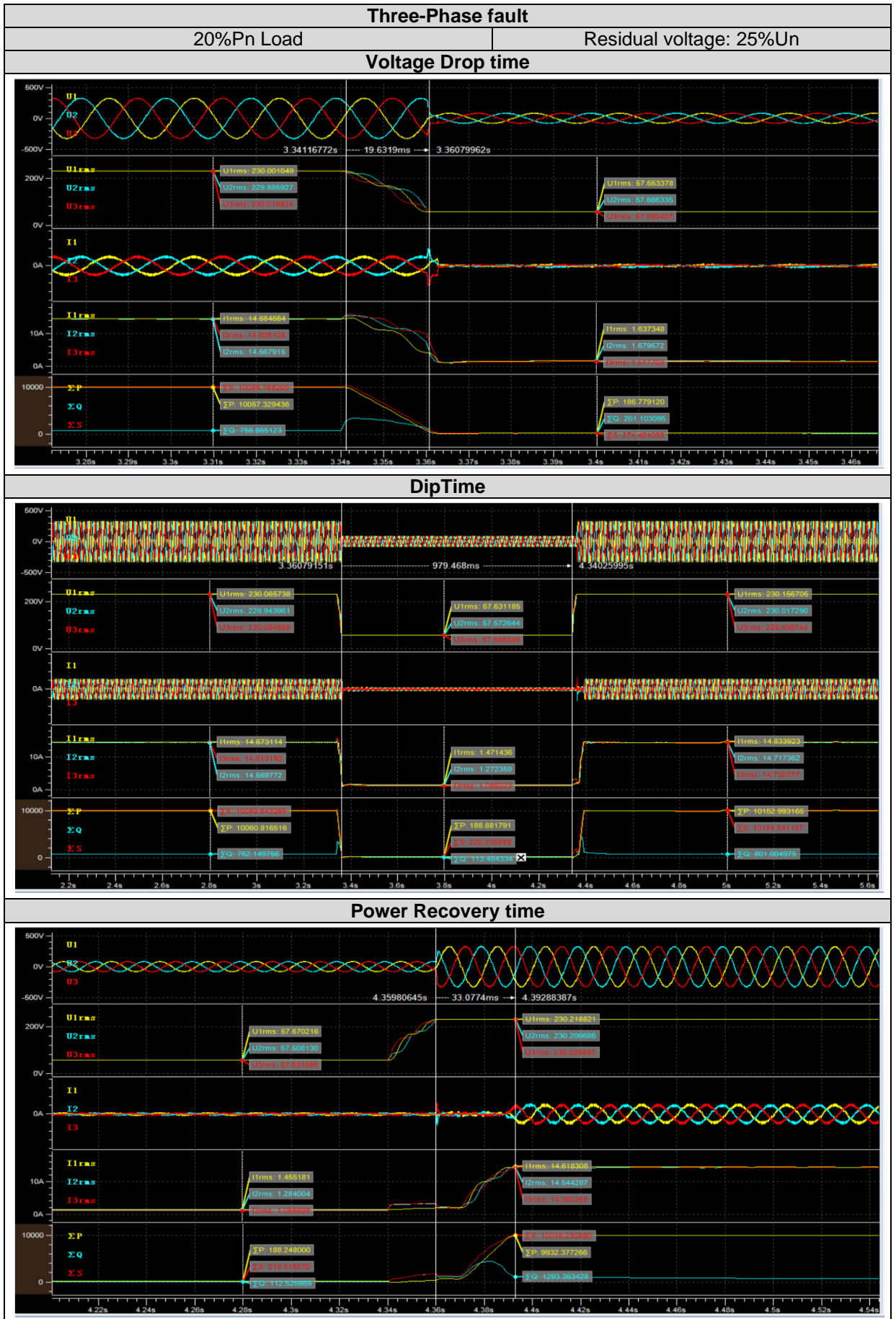

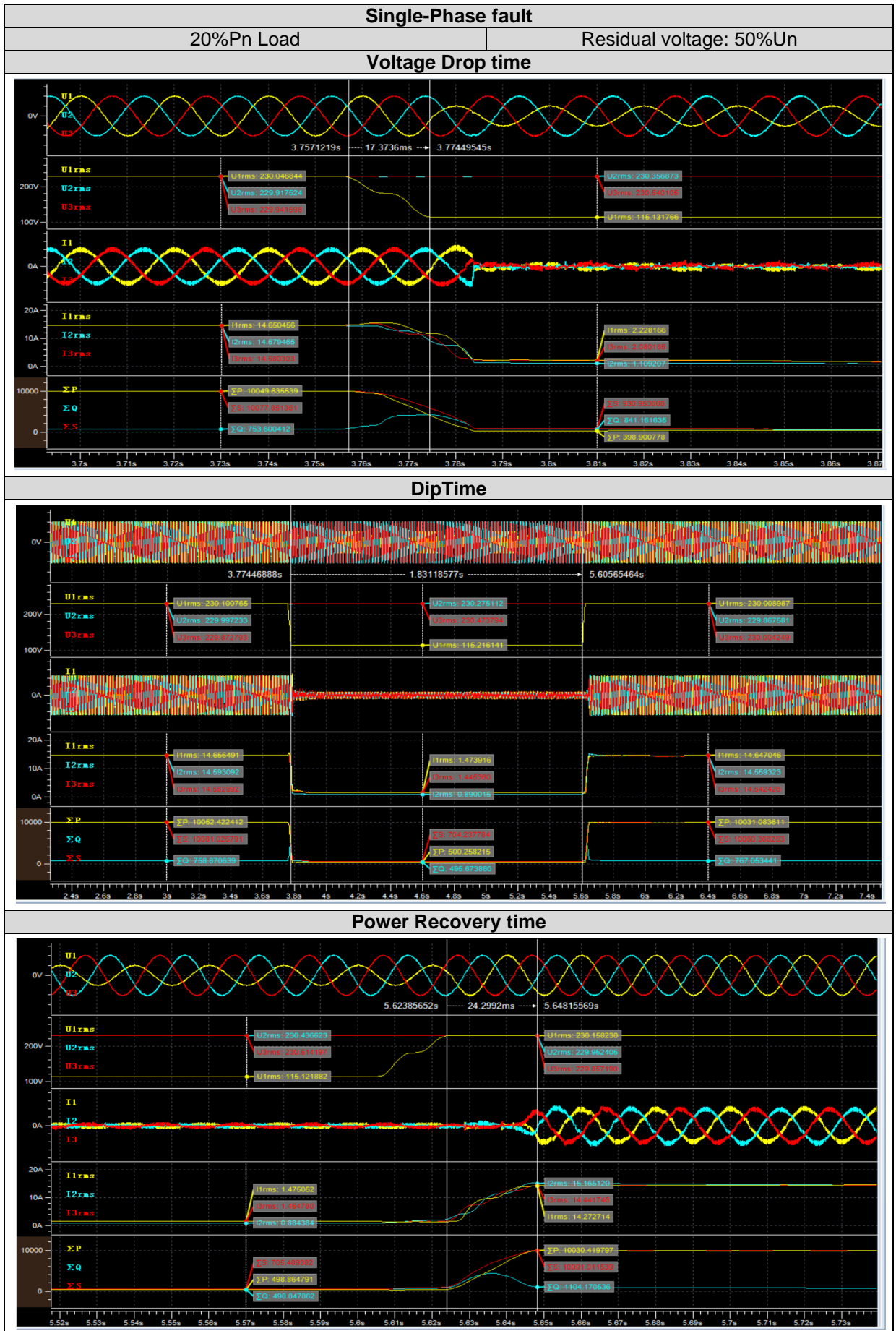

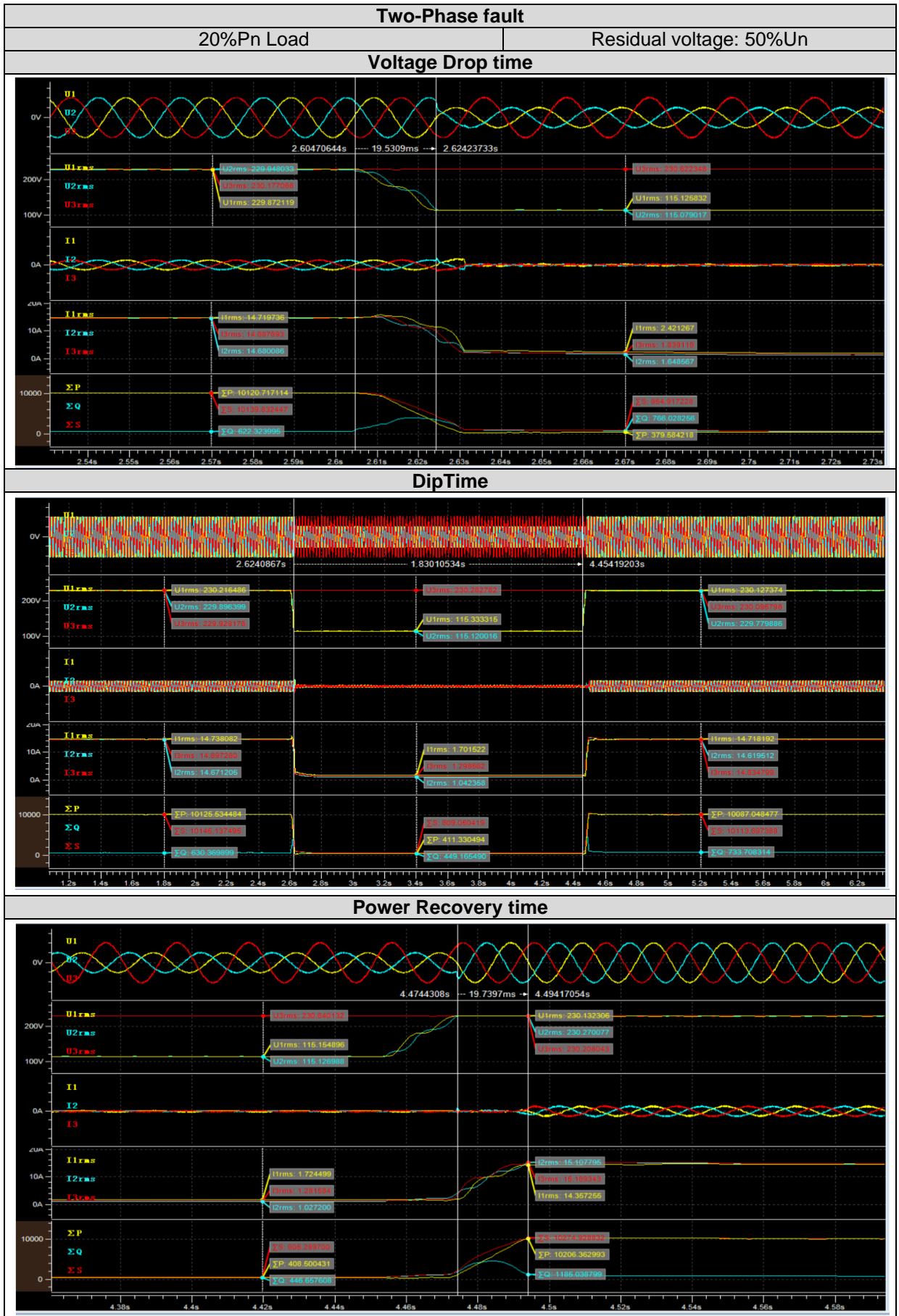

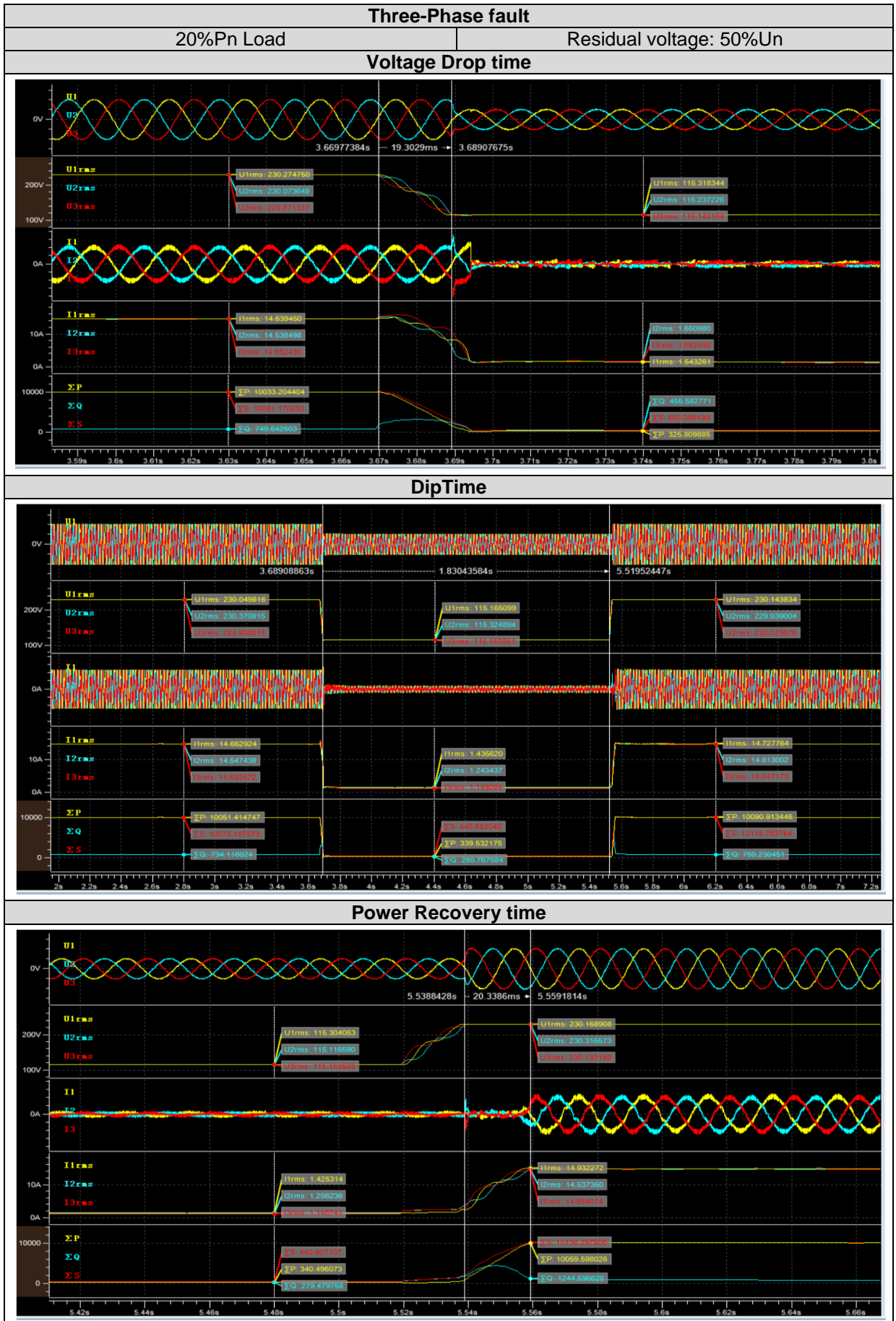

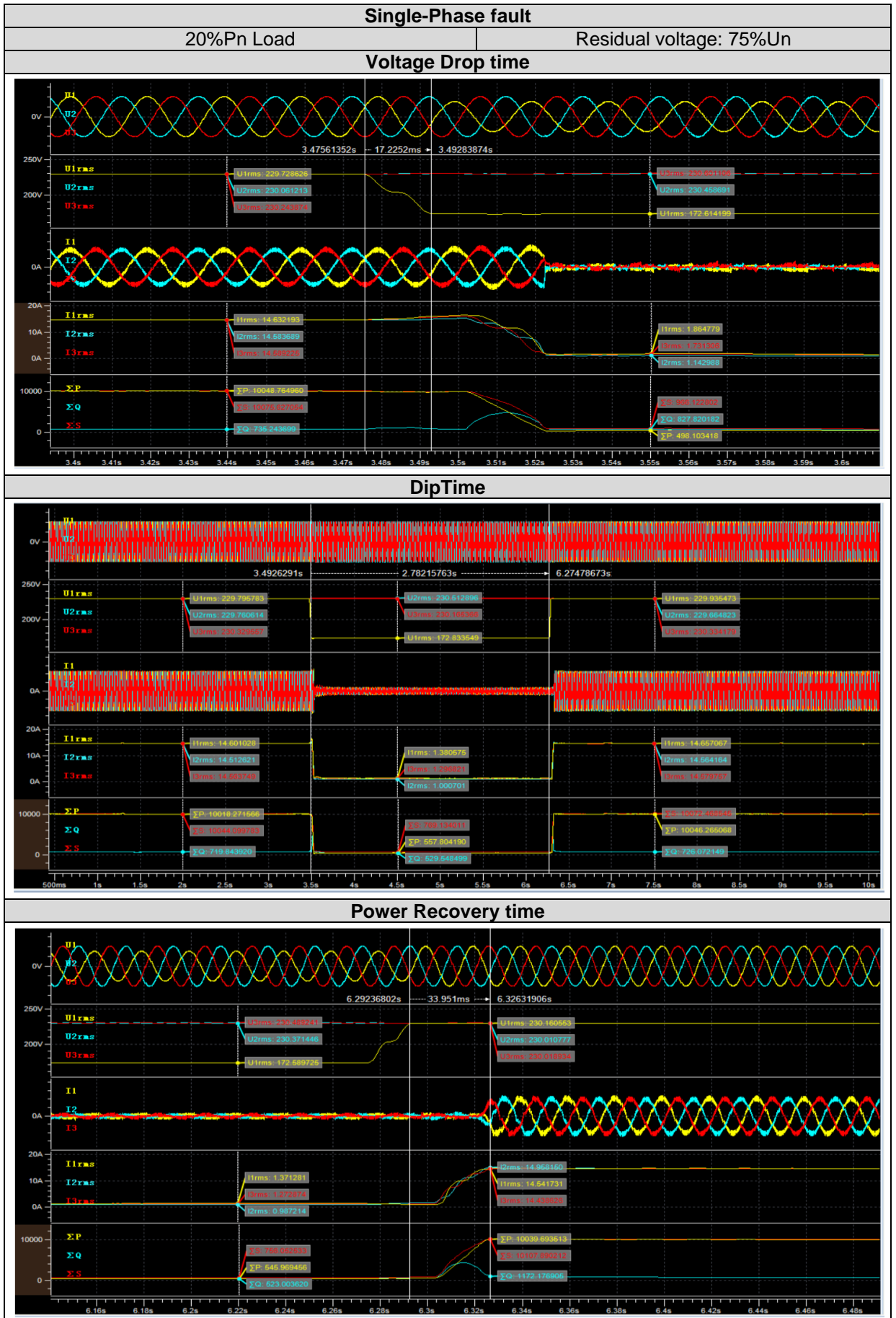



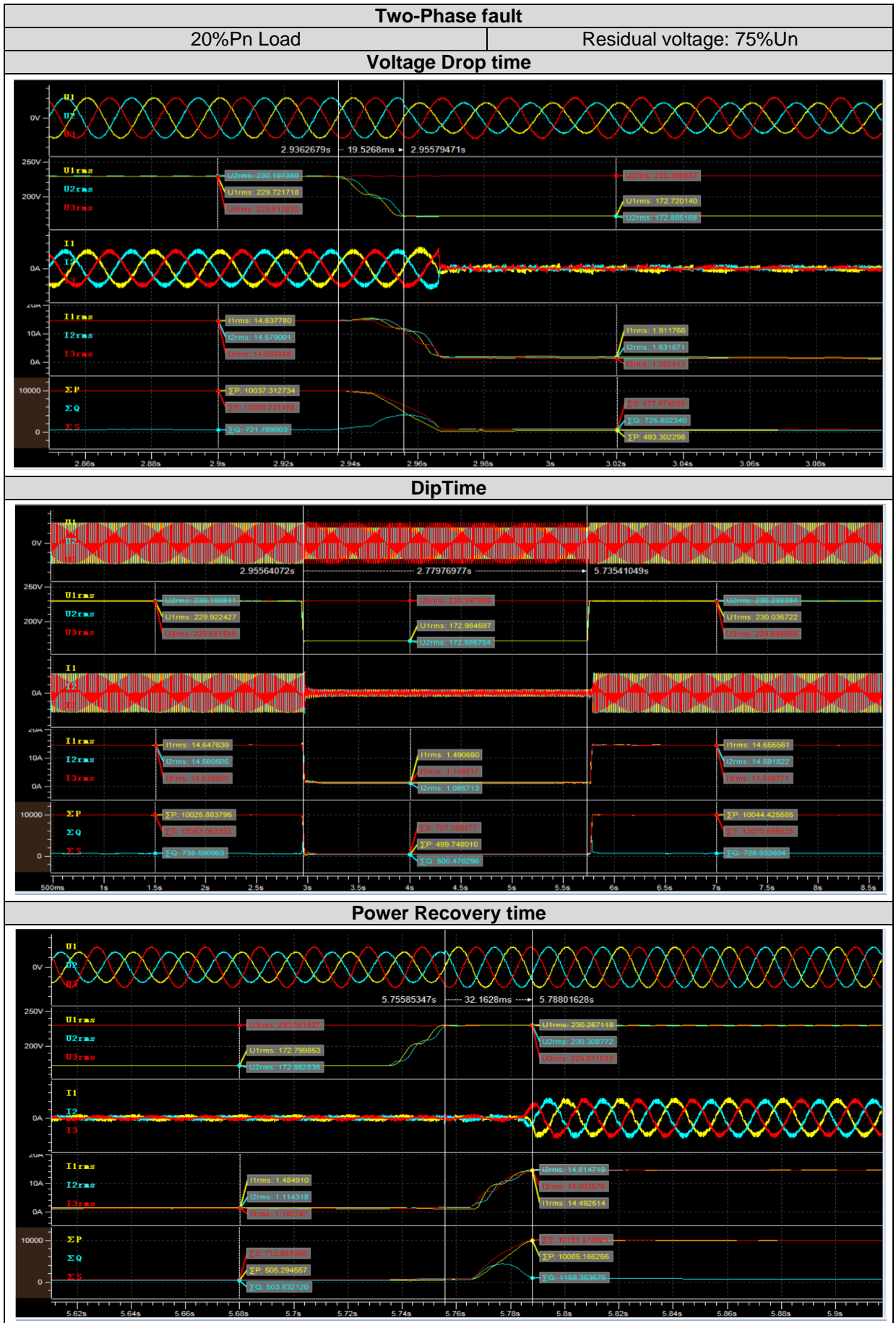

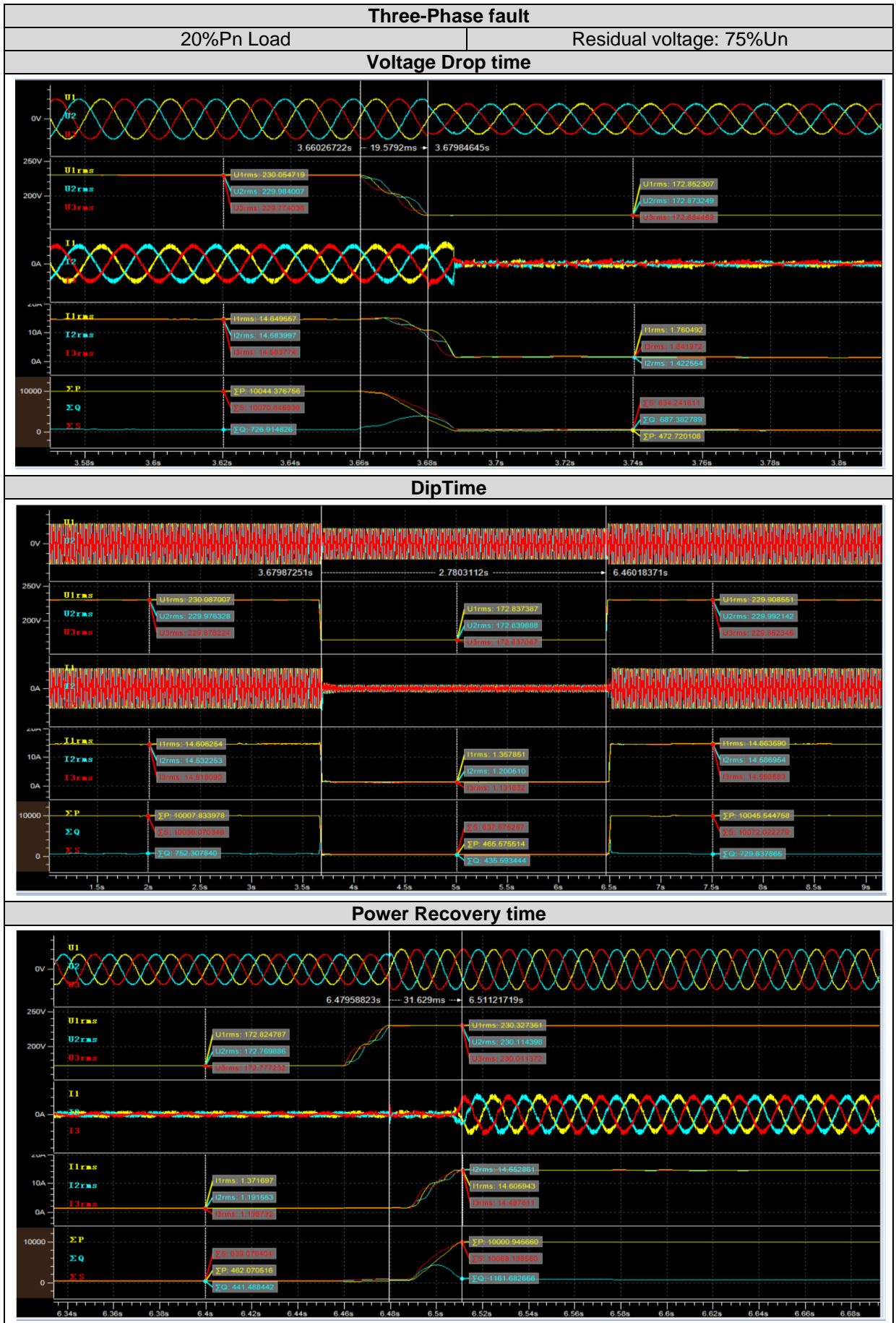

**4.2.1.3. Load Tests: Partial load (> 90 %Pn)**

Test results of different 100%Pn load cases performed are offered below:

<b>&gt; 90 %Pn Load</b>								
<b>Phase type</b>	<b>Residual voltage desired (%Un)</b>	<b>Voltage before fault (%Un)</b>	<b>Voltage drop time (ms)</b>	<b>Residual voltage Measured (%Un)</b>	<b>Dip time desired (ms)</b>	<b>Dip time measured (ms)</b>	<b>Power recovery time (ms)</b>	<b>Voltage after recovery (%Un)</b>
1 ph	0.0-5.0	100.3	18	4.1	≥ 250	261	57	100.3
2 ph		100.2	20	4.1		260	58	100.2
3 ph		100.2	20	4.0		260	58	100.2
1 ph	25.0	100.0	19	25.0	≥ 938	981	52	100.1
2 ph		100.1	20	25.0		979	48	100.2
3 ph		100.1	20	25.0		980	47	100.2
1 ph	50.0	100.1	16	50.1	≥ 1797	1832	43	100.1
2 ph		100.0	20	50.1		1830	38	100.2
3 ph		100.1	19	50.1		1830	58	100.0
1 ph	75.0	100.2	15	75.2	≥ 2656	2783	53	100.2
2 ph		100.0	19	75.2		2780	52	100.2
3 ph		100.1	19	75.1		2781	52	100.1

Test results are graphically represented at following pages.

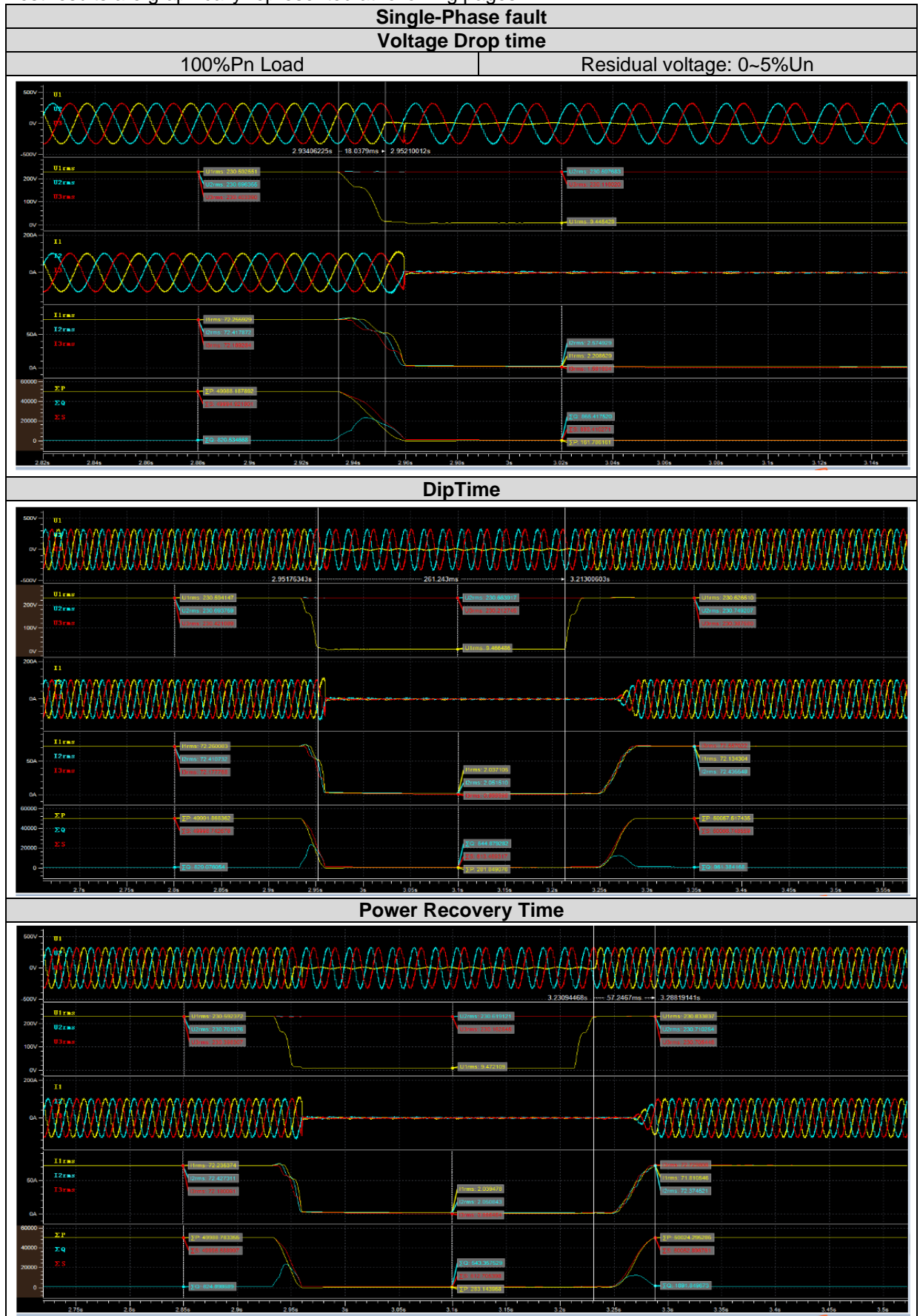

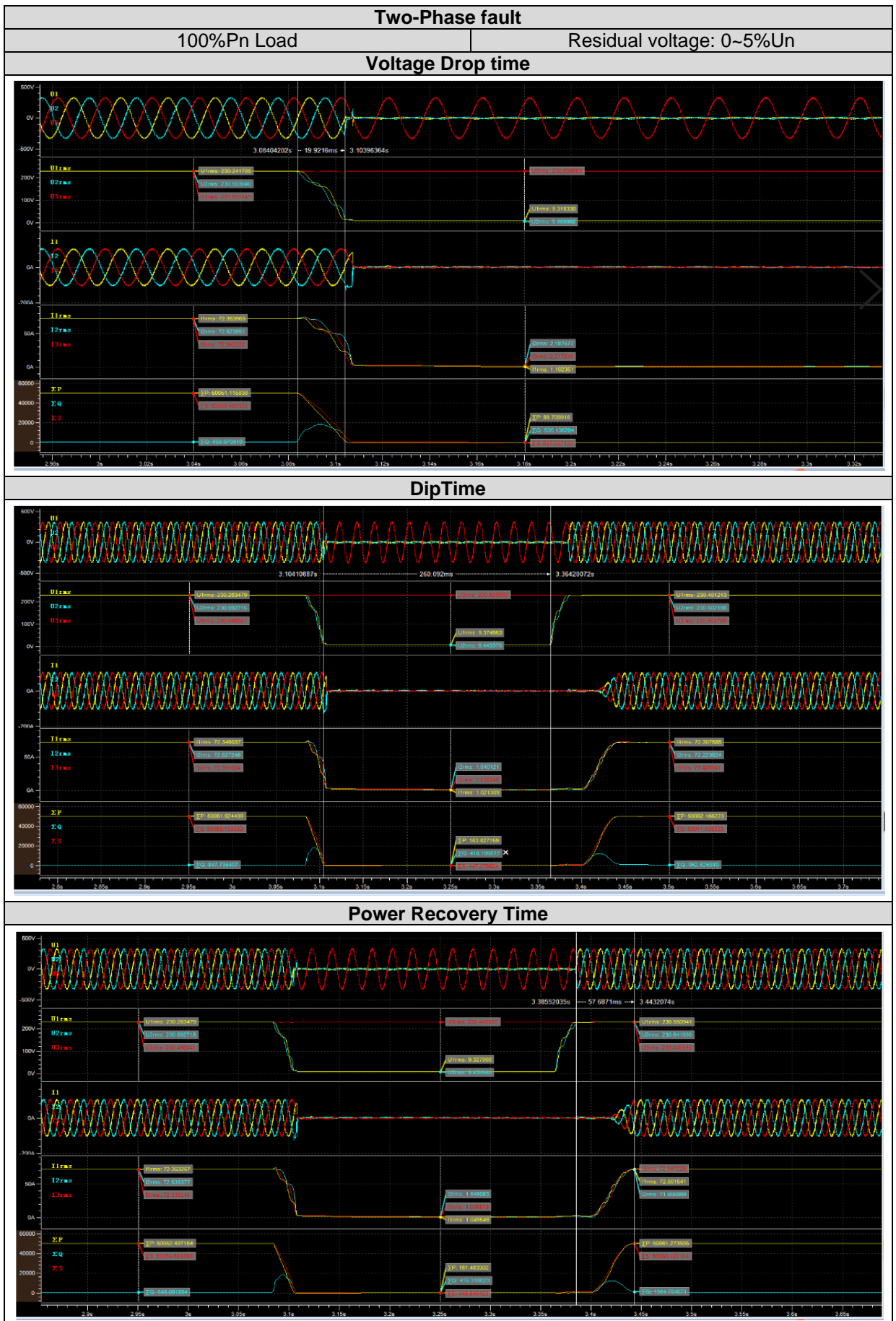

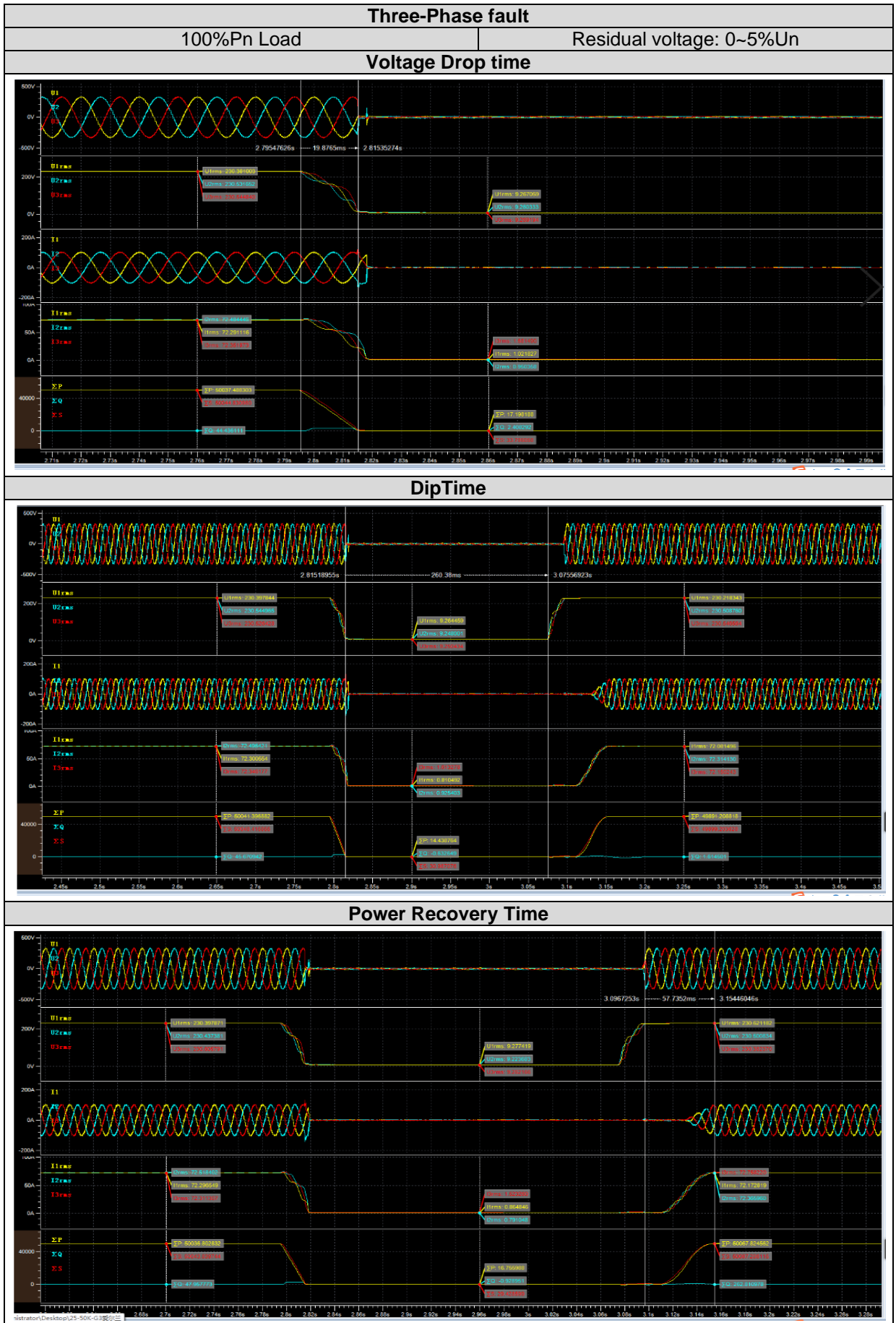

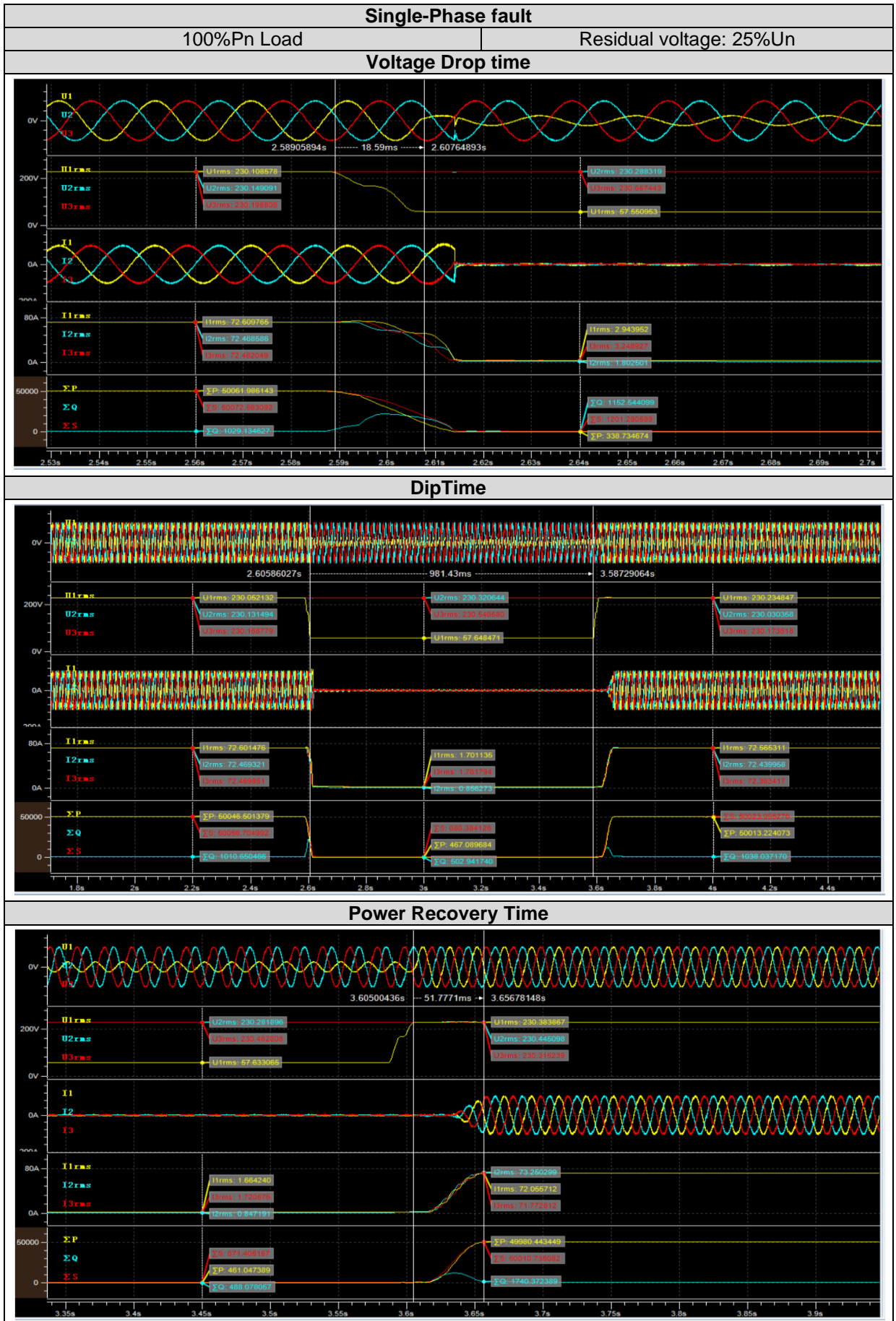

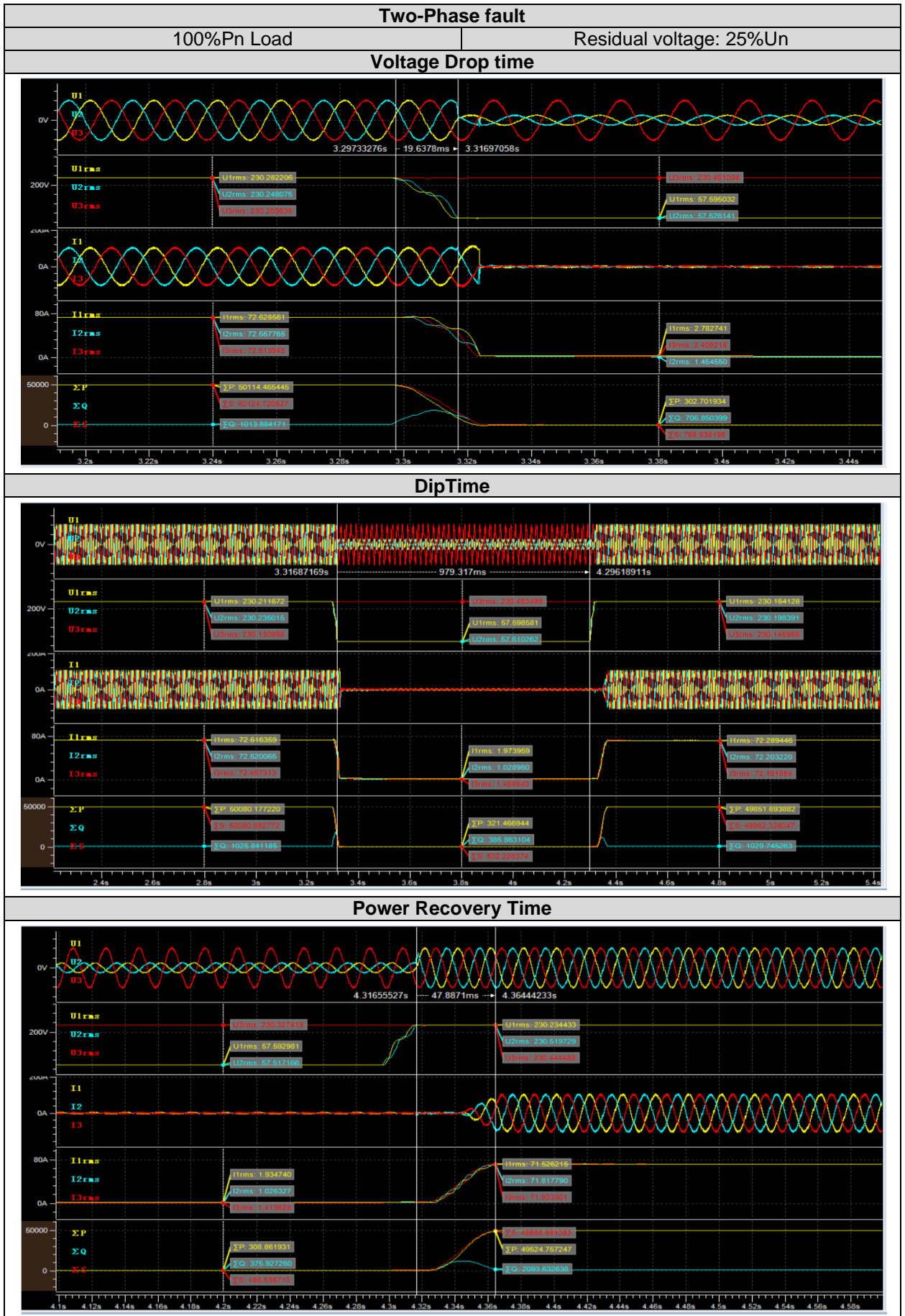



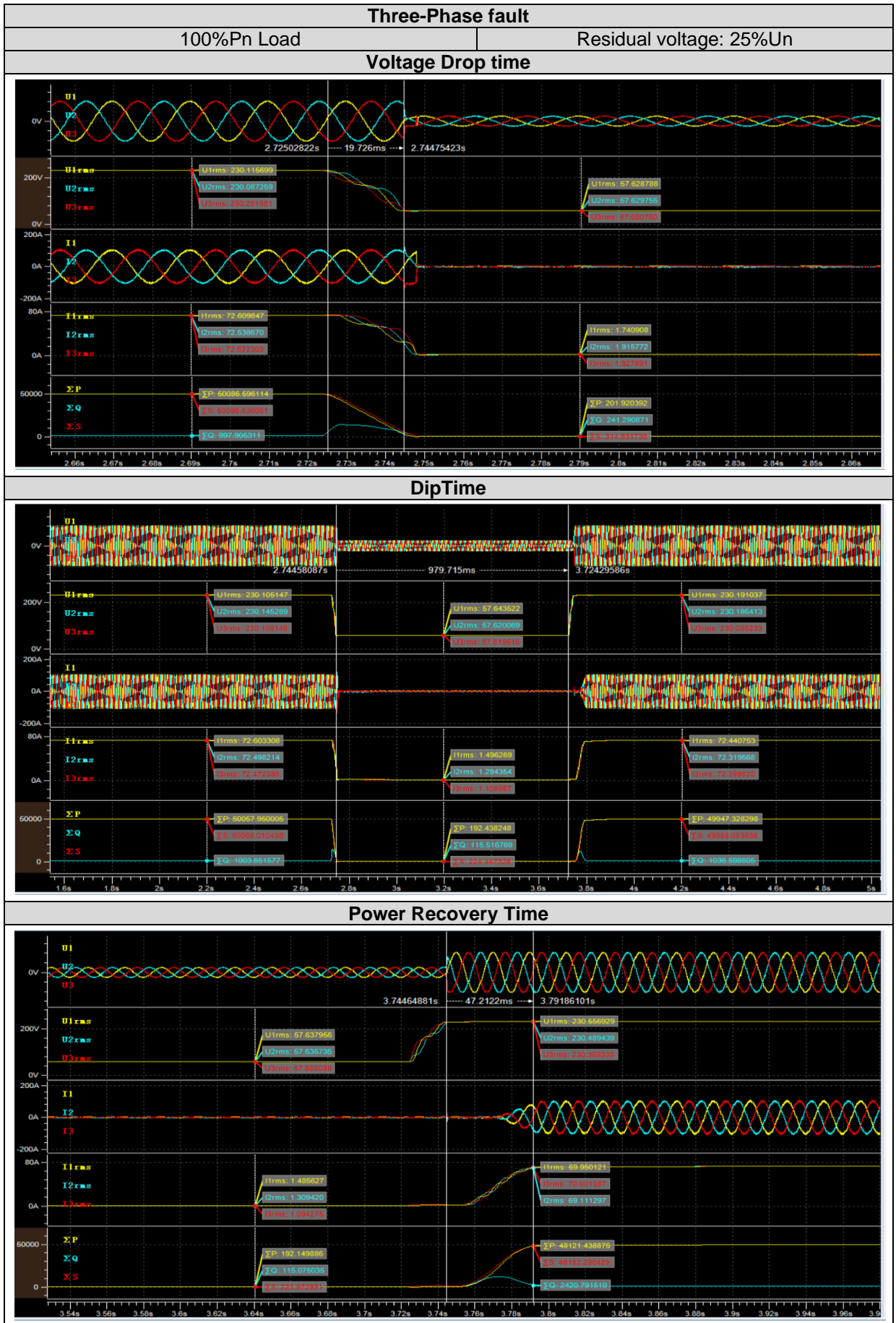

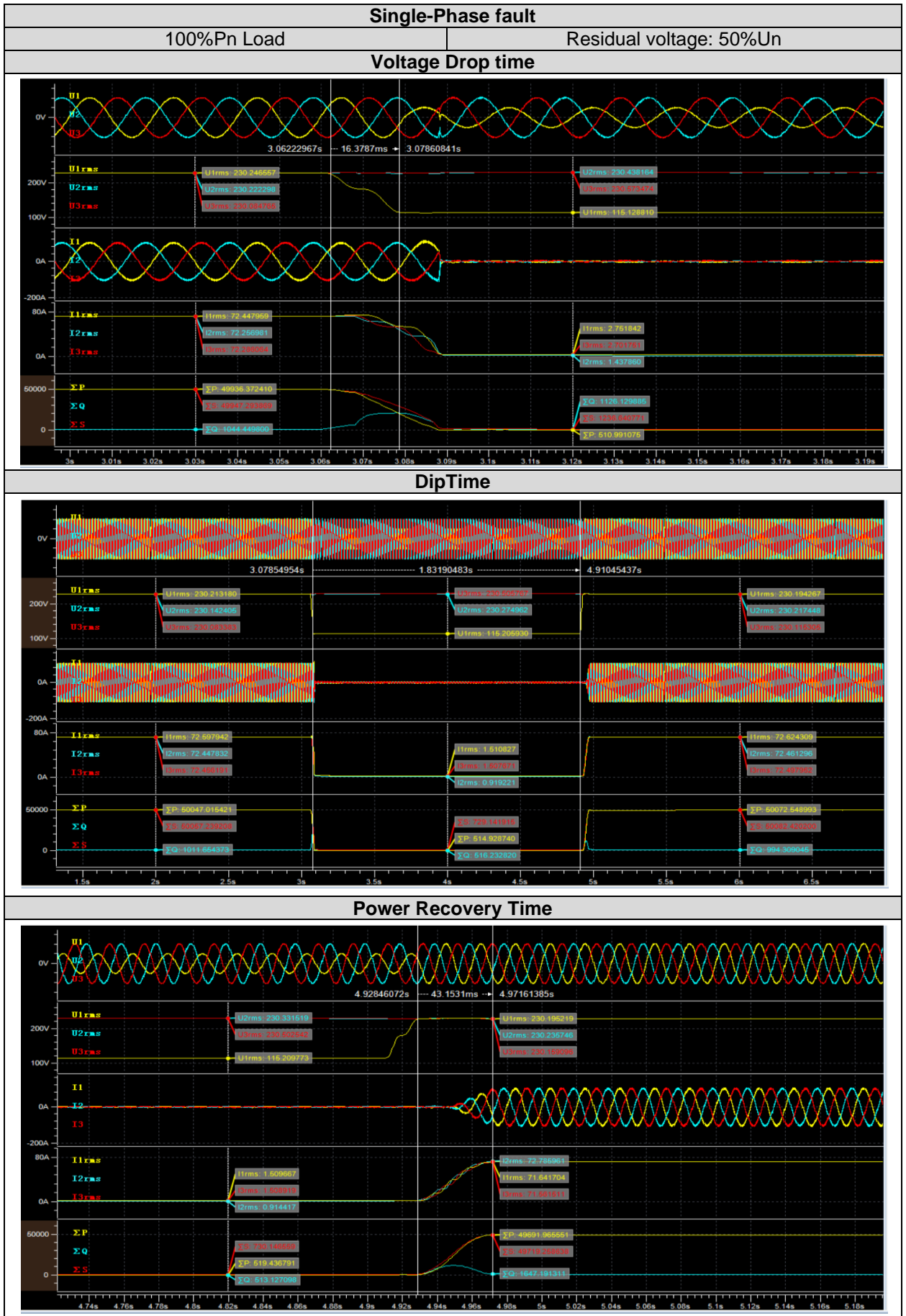

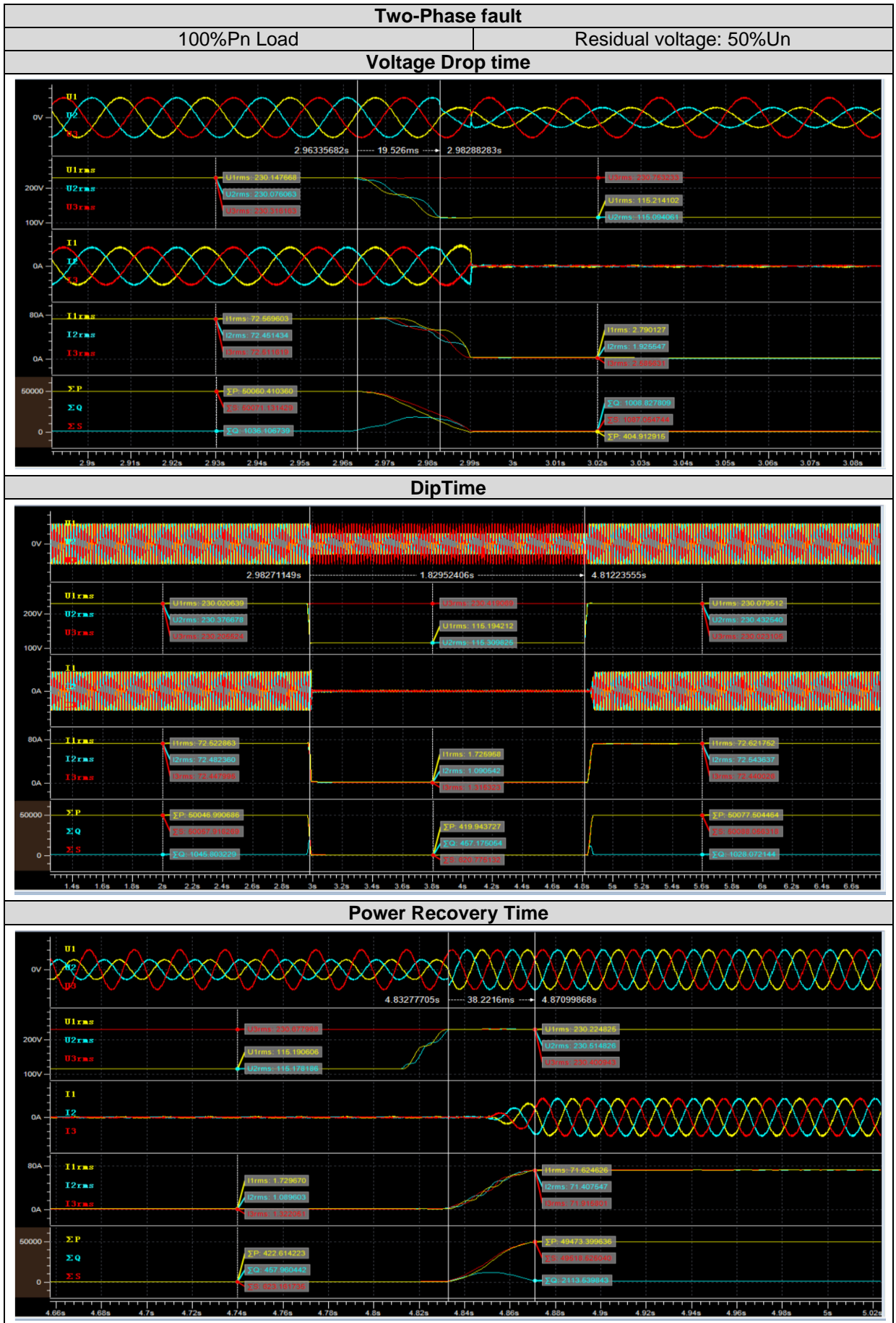

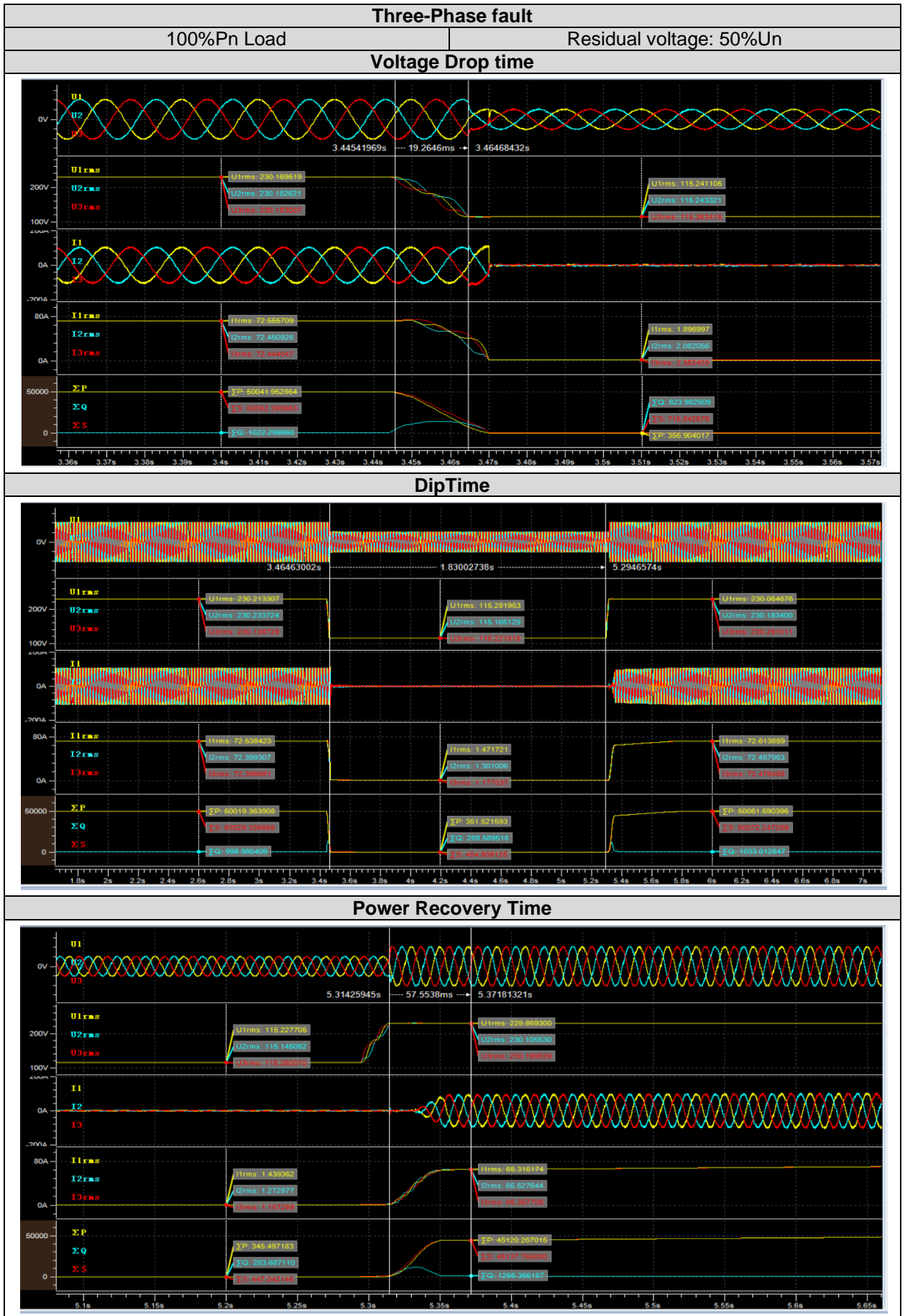

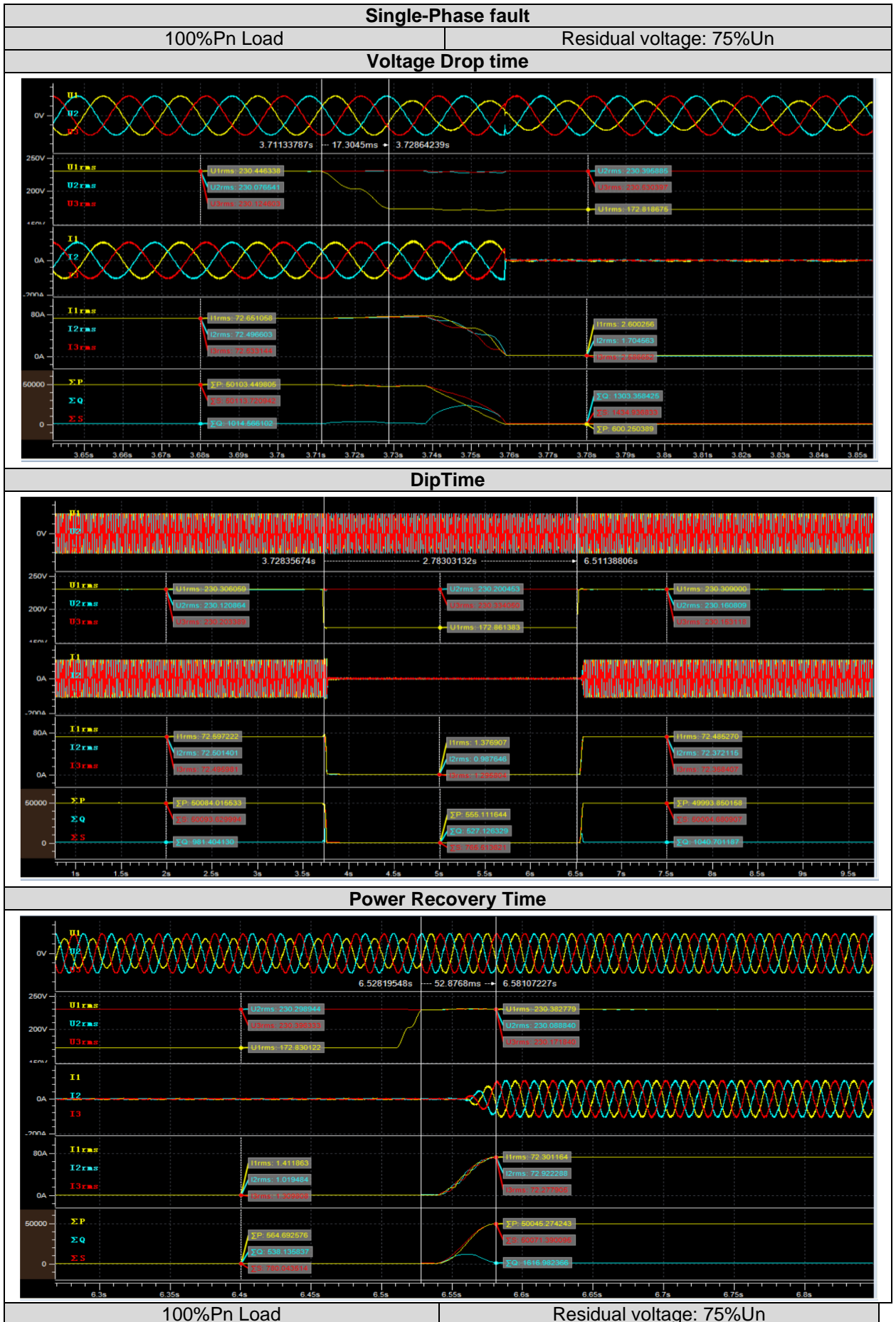

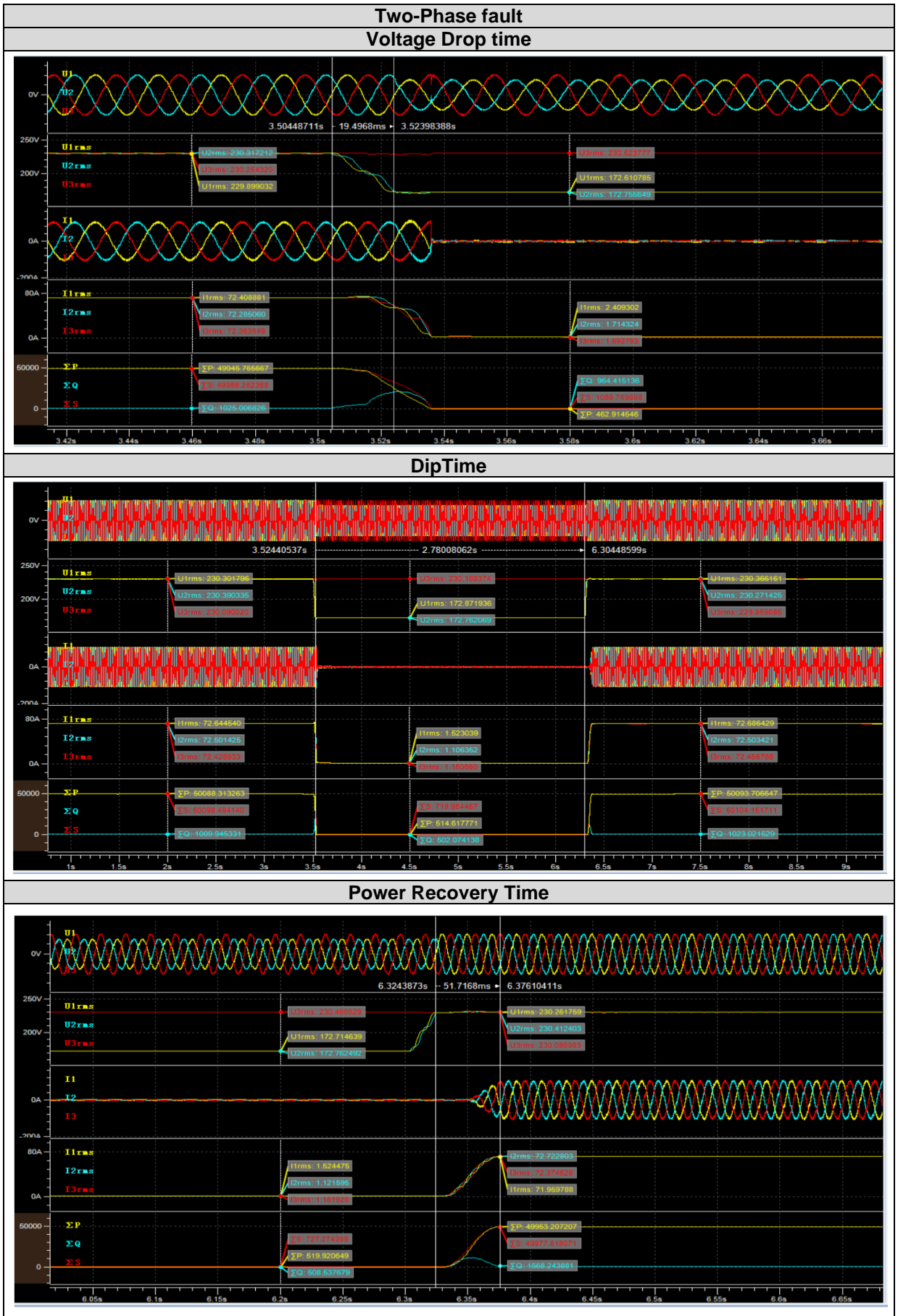

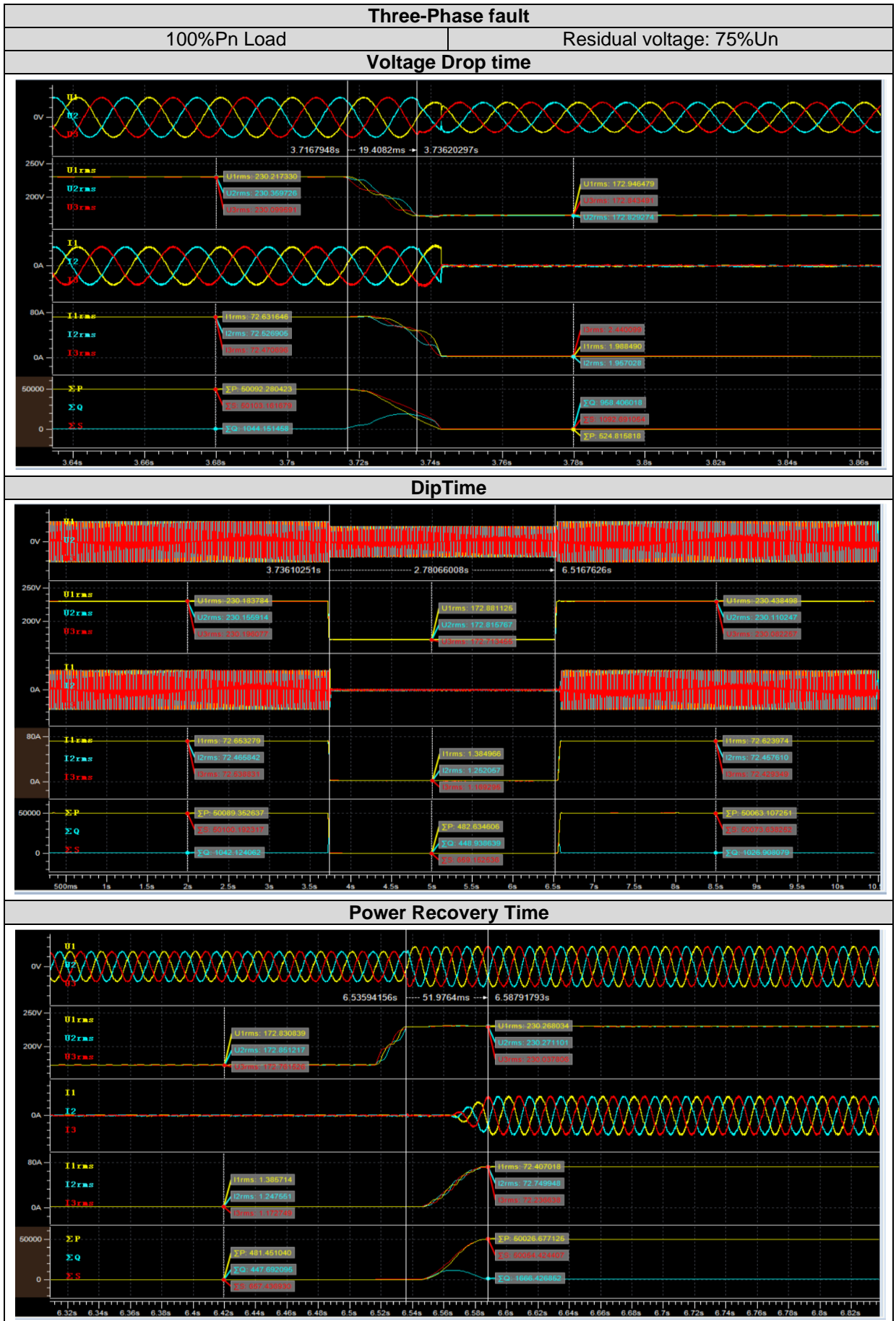

**4.2.3. Over-voltage ride through (OVRT)**

The test has been done according to the clause 4.5.4 of the standard. The setting of over-voltage ride through capability is as follows:

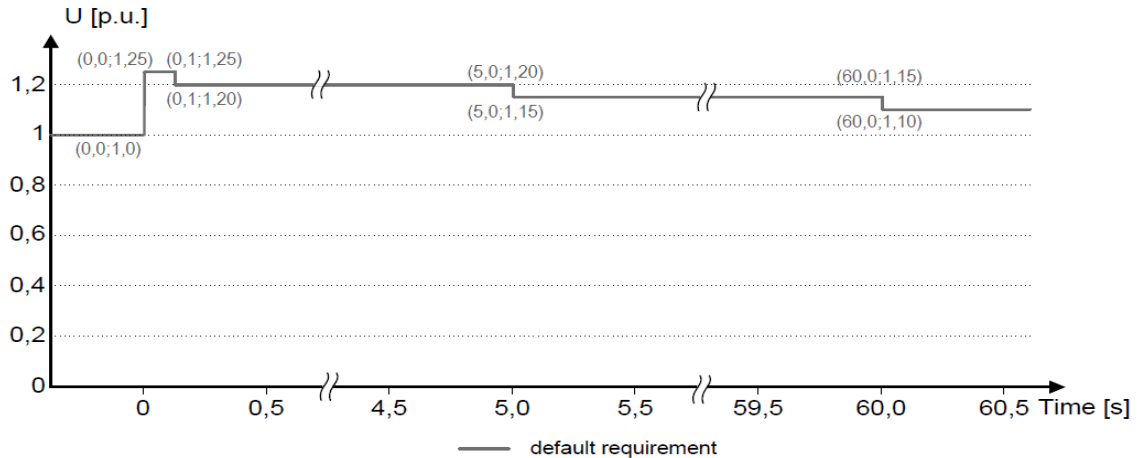

**Figure 8 — Over-voltage ride through capability**

**4.2.3.1 No load Test**

It is not specified in the reference standard, but following tolerances have been applied. Tolerances for drop depth and duration during no-load tests shall not exceed the values shown in the next figure:

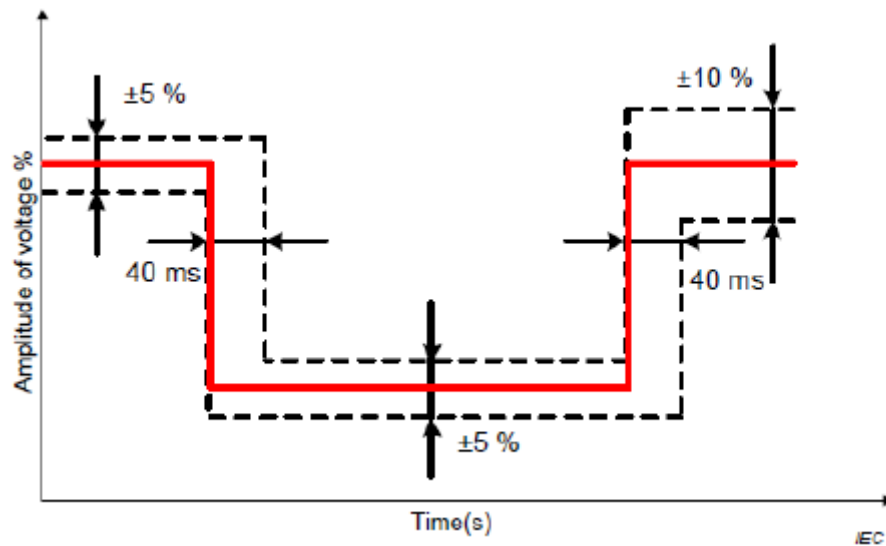

The tolerance for voltage magnitude is  $\pm 5\%U_n$  for the period before and during the voltage drop. The tolerance for voltage magnitude is  $\pm 10\%U_n$  during the period after voltage is recovered. The tolerance range for both drop duration and rise time prefers 40 ms.



Test results of different no-load cases performed are offered below:

Single-Phase fault							
Residual voltage Desired (%Un)	Voltage before sag (%Un)	Voltage Rise time (ms)	Residual voltage Measured (%Un)	DipTime (ms)		Power Recovery time (ms)	Voltage after Recovery (%Un)
				Desired	Meas.		
125.0	100.0	18	125.1	> 100	112	--	100.0
120.0	99.9	17	120.1	> 5000	5032	--	100.0
115.0	100.0	10	115.2	> 60000	60040	--	99.9

Two-Phase fault							
Residual voltage Desired (%Un)	Voltage before sag (%Un)	Voltage Rise time (ms)	Residual voltage Measured (%Un)	DipTime (ms)		Power Recovery time (ms)	Voltage after Recovery (%Un)
				Desired	Meas.		
125.0	100.0	20	125.2	> 100	111	--	100.0
120.0	100.0	20	120.2	> 5000	5030	--	100.0
115.0	100.0	20	115.2	> 60000	60030	--	99.9

Three-Phase fault							
Residual voltage Desired (%Un)	Voltage before sag (%Un)	Voltage Rise time (ms)	Residual voltage Measured (%Un)	DipTime (ms)		Power Recovery time (ms)	Voltage after Recovery (%Un)
				Desired	Meas.		
125.0	100.0	20	125.2	> 100	111	--	100.0
120.0	100.0	20	120.2	> 5000	5031	--	100.0
115.0	100.0	20	115.2	> 60000	60030	--	100.0

Test results are graphically represented at following pages.

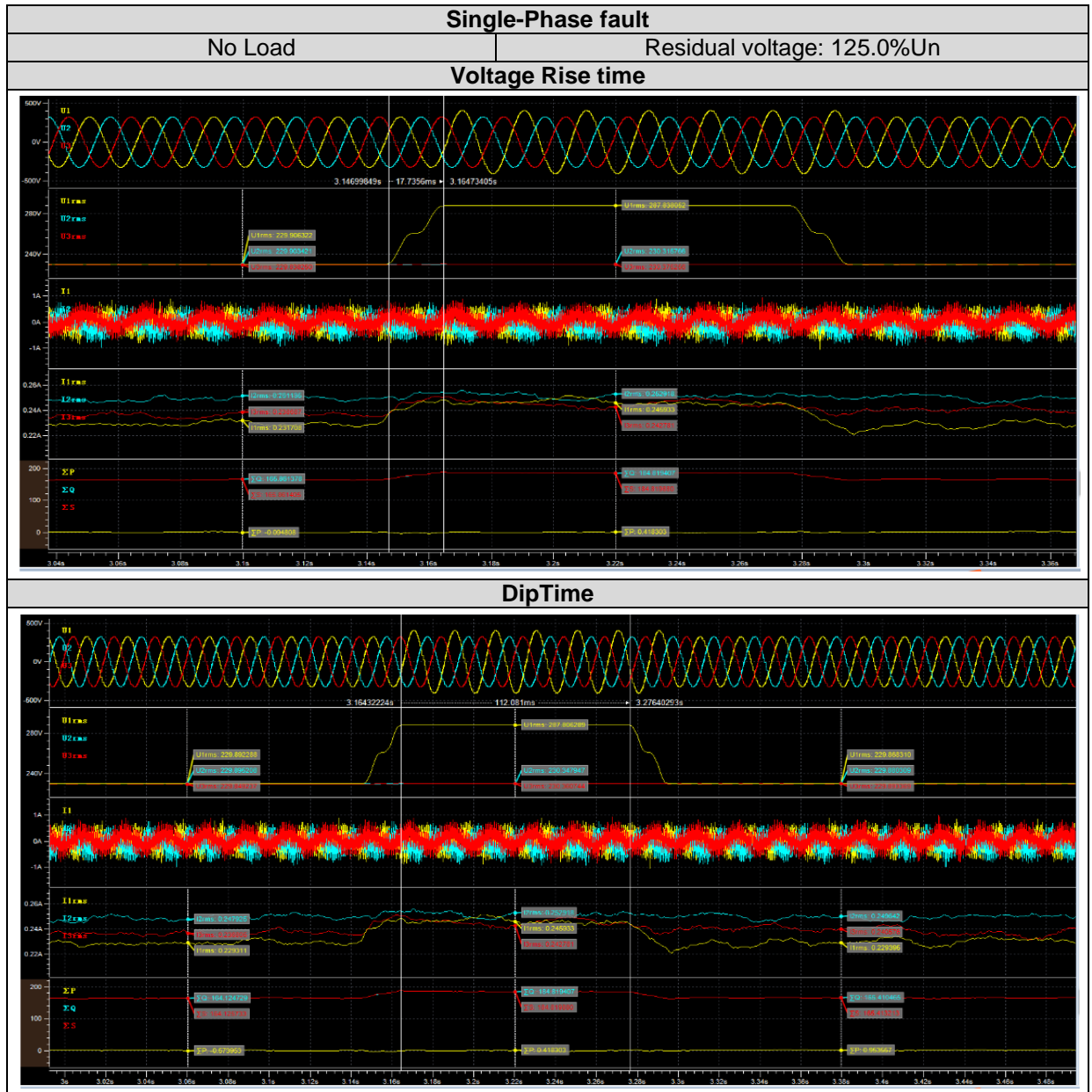

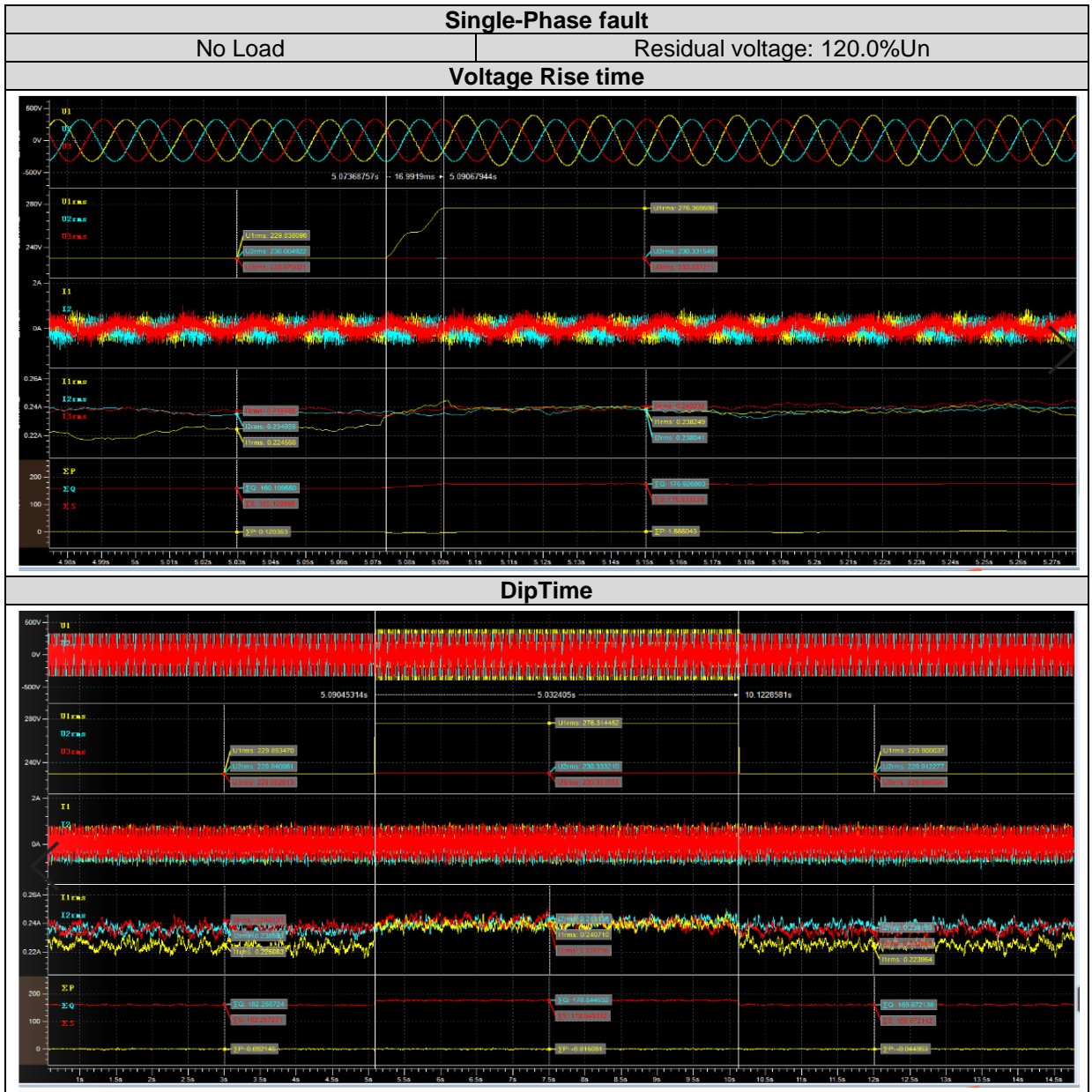

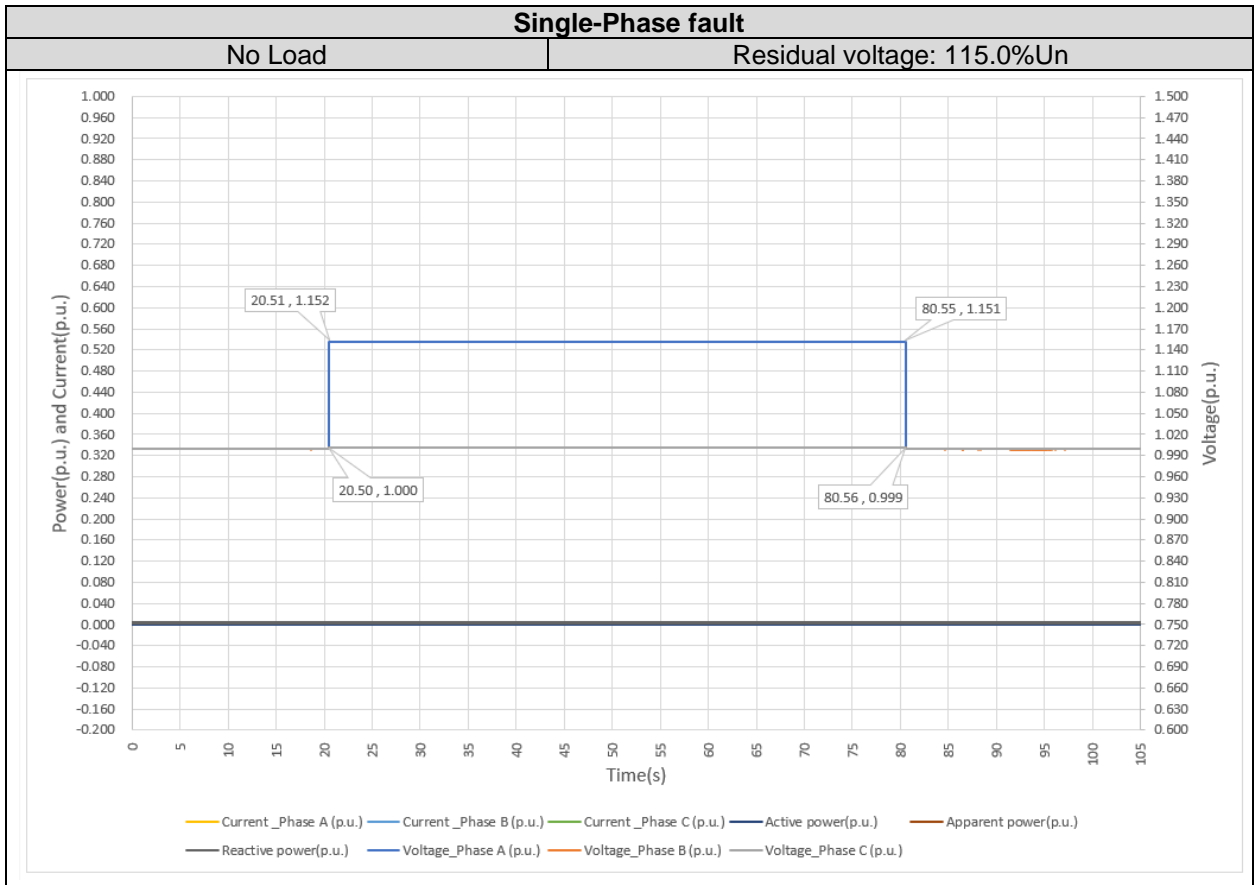

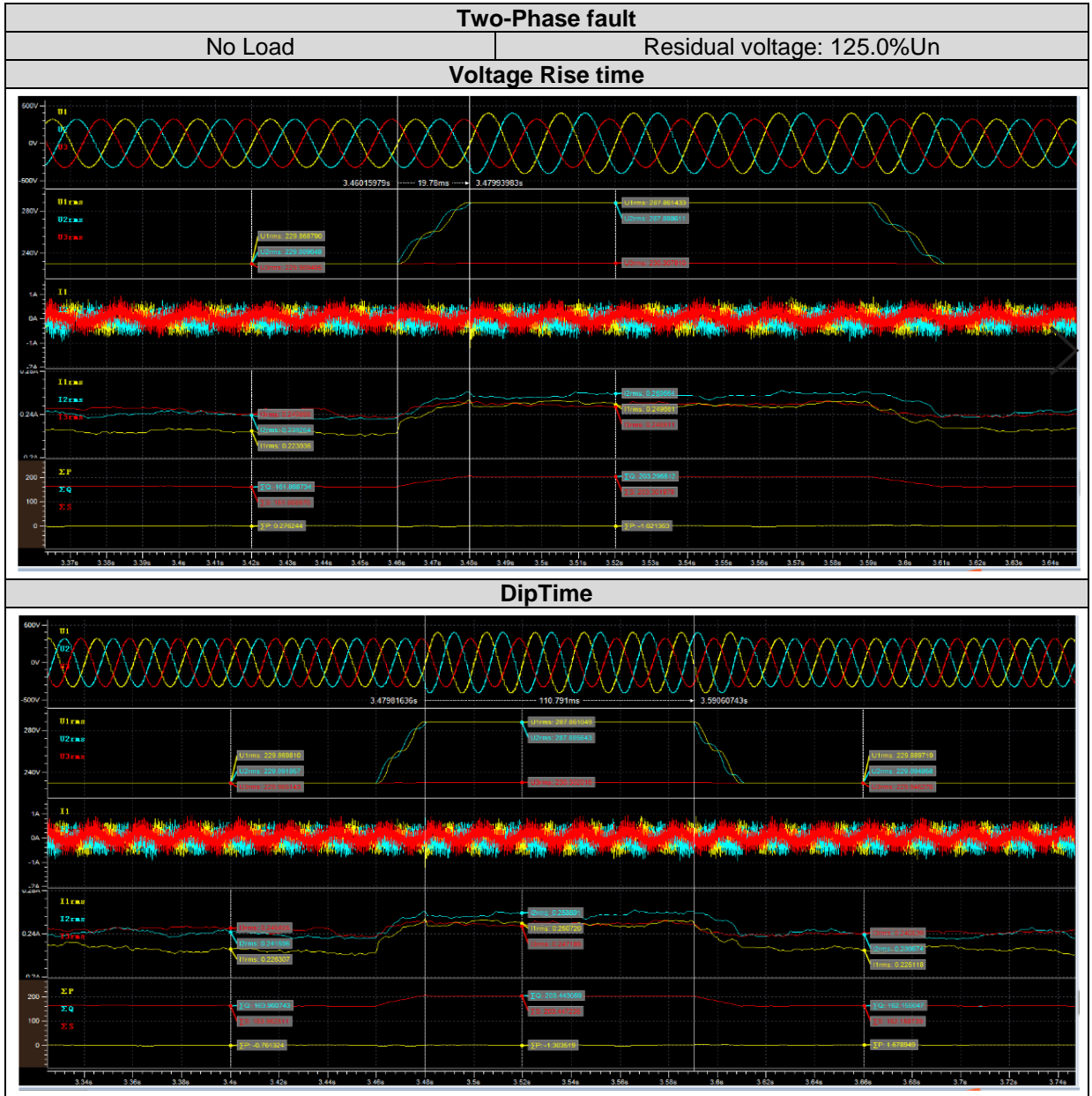

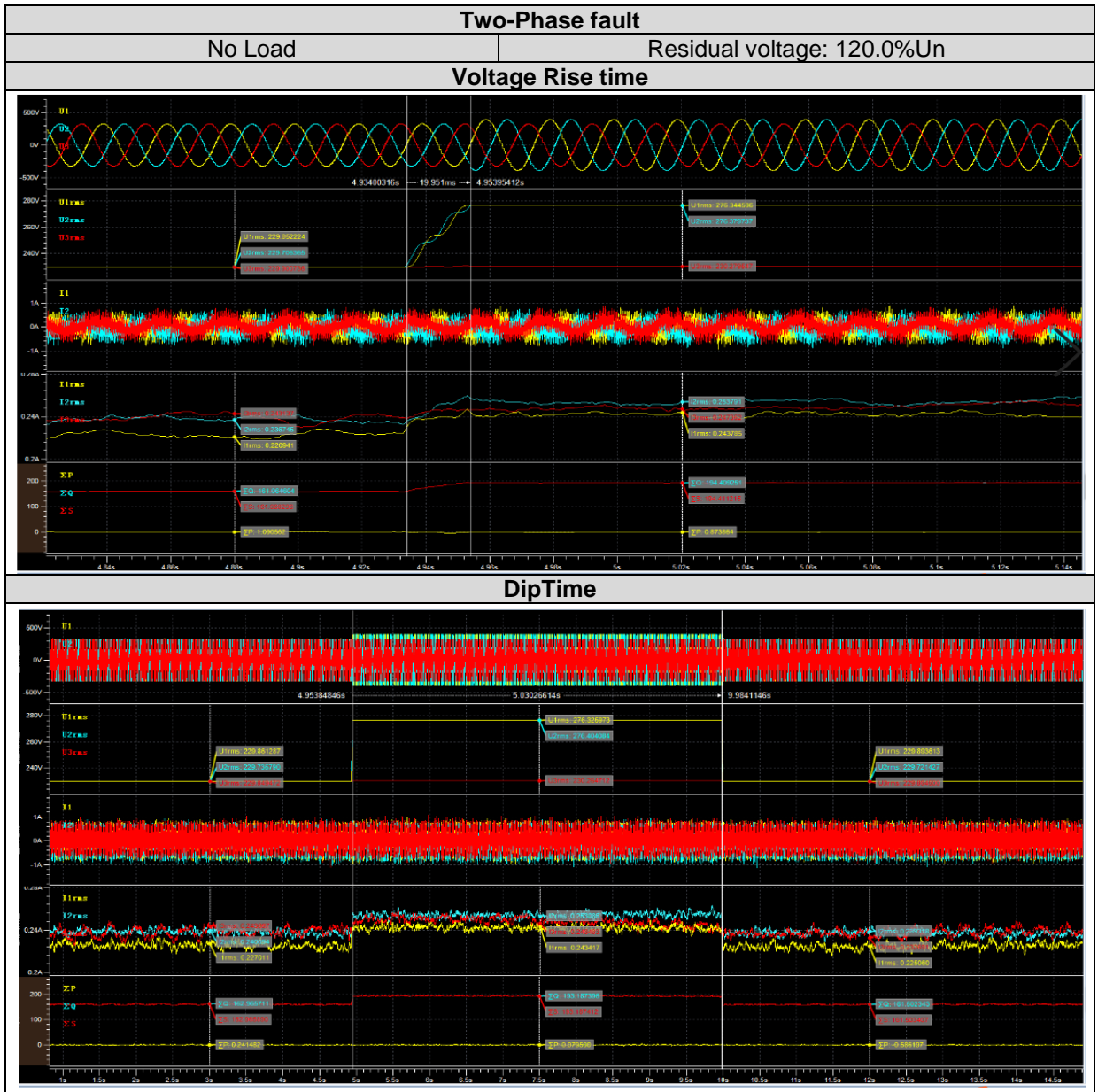

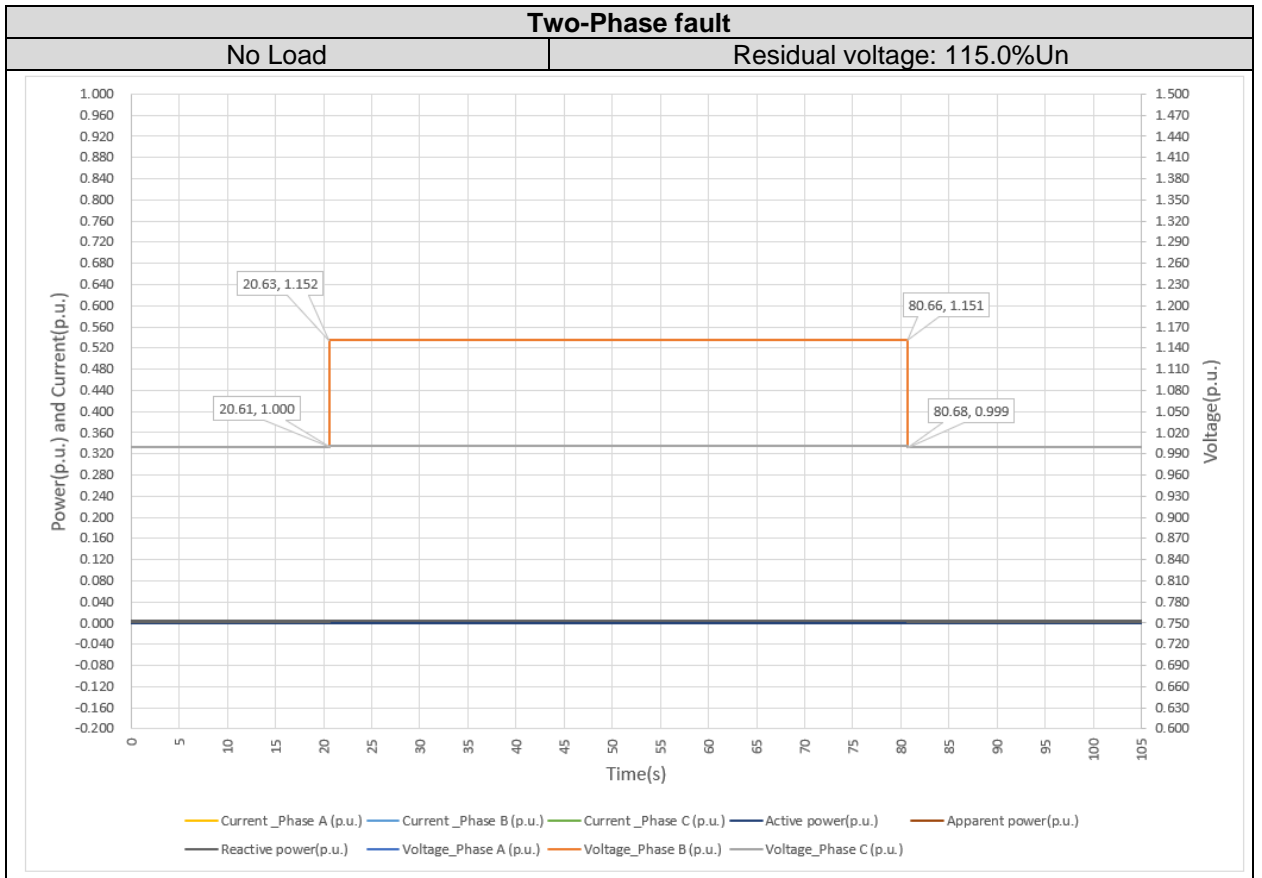

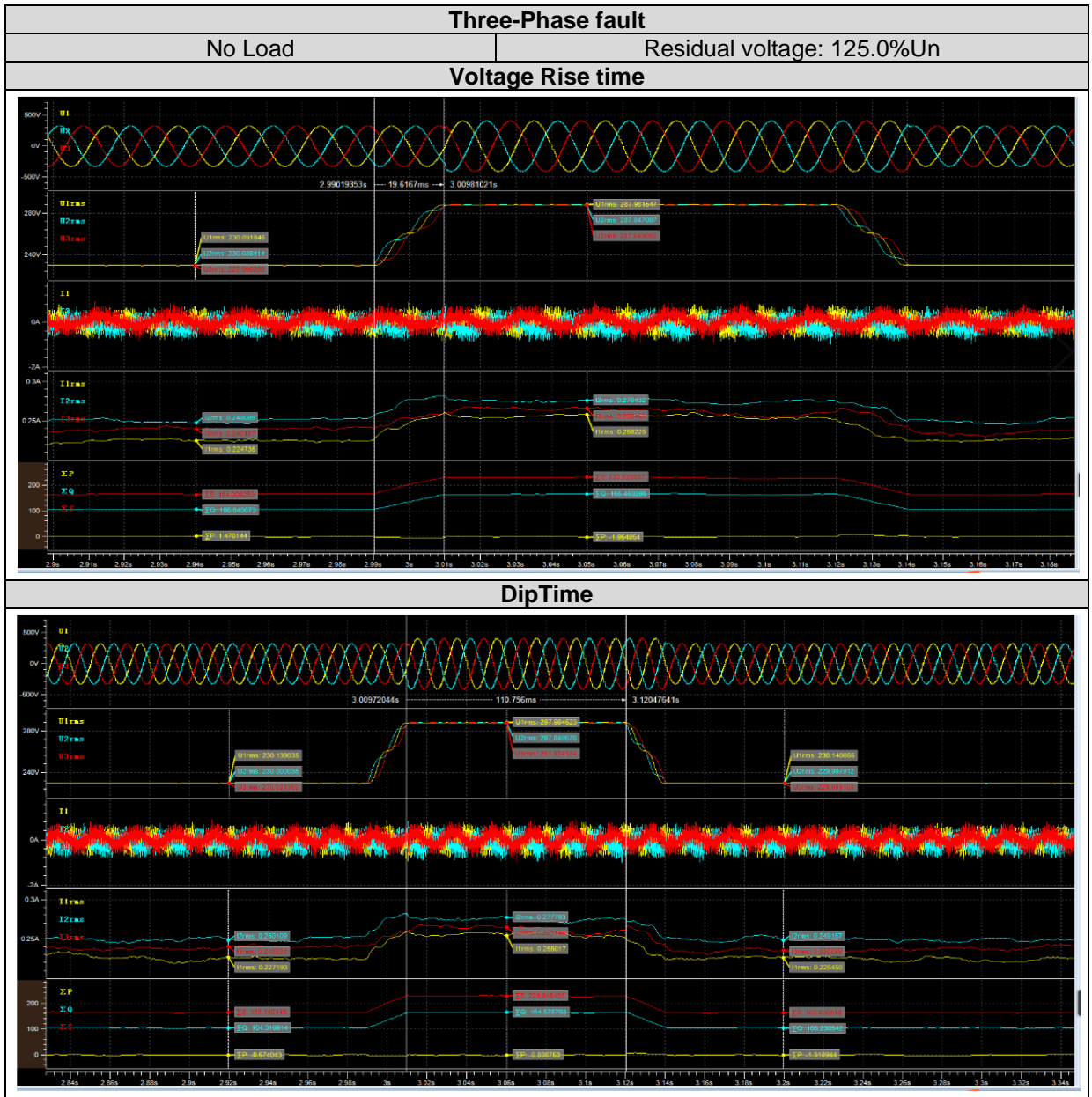



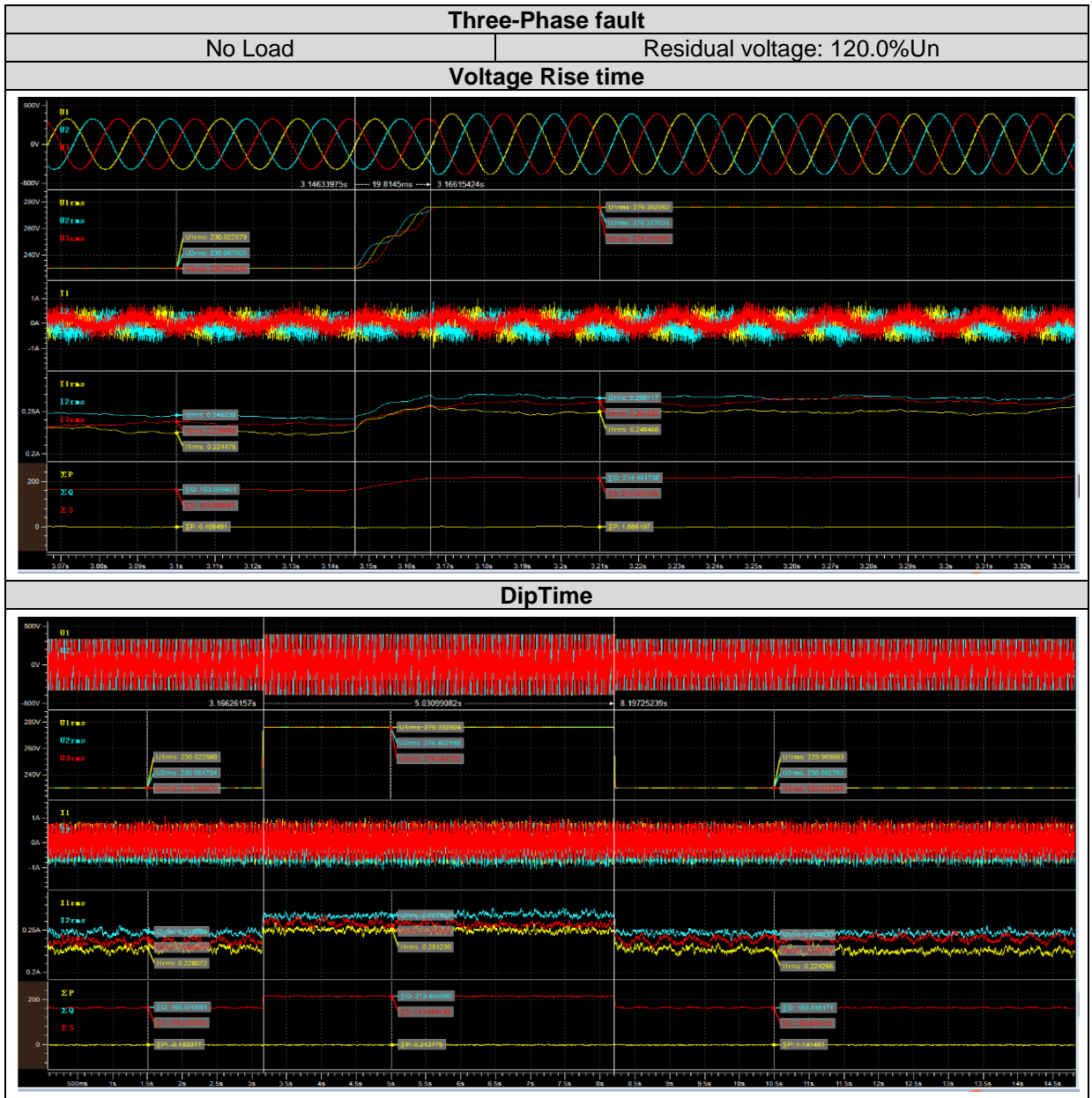

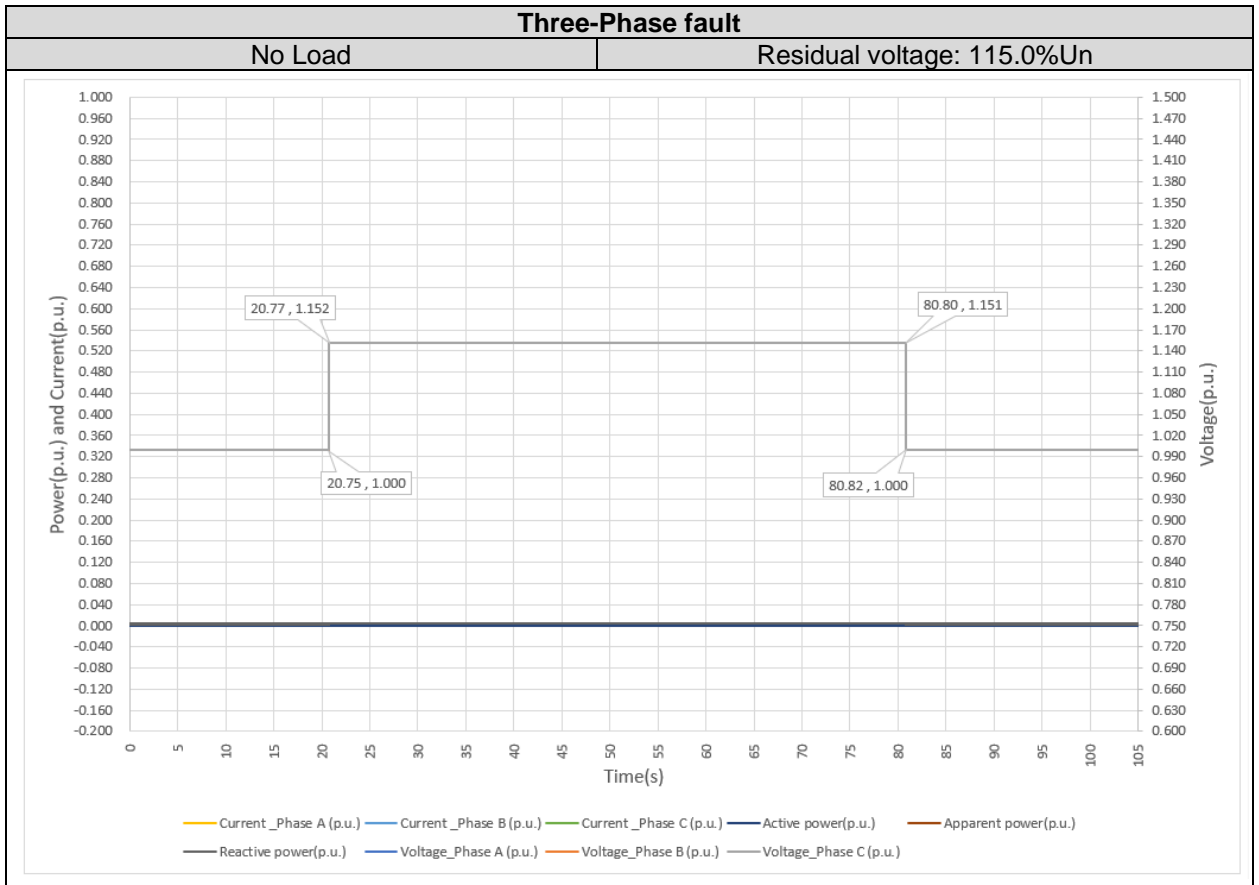

#### 4.2.3.2 Load Tests: Partial load (20%Pn)

Test results of 20%Pn power cases performed are offered below:

Single-Phase fault							
Residual voltage Desired (%Un)	Voltage before sag (%Un)	Voltage Rise time (ms)	Residual voltage Measured (%Un)	DipTime (ms)		Power Recovery time (ms)	Voltage after Recovery (%Un)
				Desired	Meas.		
125.0	100.1	18	125.2	> 100	112	30	100.1
120.0	100.1	17	120.1	> 5000	5032	29	100.2
115.0	100.1	20	115.3	> 60000	60030	30	100.0

Two-Phase fault							
Residual voltage Desired (%Un)	Voltage before sag (%Un)	Voltage Rise time (ms)	Residual voltage Measured (%Un)	DipTime (ms)		Power Recovery time (ms)	Voltage after Recovery (%Un)
				Desired	Meas.		
125.0	100.0	20	125.2	> 100	111	28	100.1
120.0	100.0	20	120.2	> 5000	5030	29	100.0
115.0	100.1	20	115.0	> 60000	60030	30	99.9

Three-Phase fault							
Residual voltage Desired (%Un)	Voltage before sag (%Un)	Voltage Rise time (ms)	Residual voltage Measured (%Un)	DipTime (ms)		Power Recovery time (ms)	Voltage after Recovery (%Un)
				Desired	Meas.		
125.0	100.0	20	125.2	> 100	110	29	100.1
120.0	100.0	20	120.1	> 5000	5031	29	100.1
115.0	100.1	20	115.1	> 60000	60030	20	99.9

Test results are graphically represented at following pages.

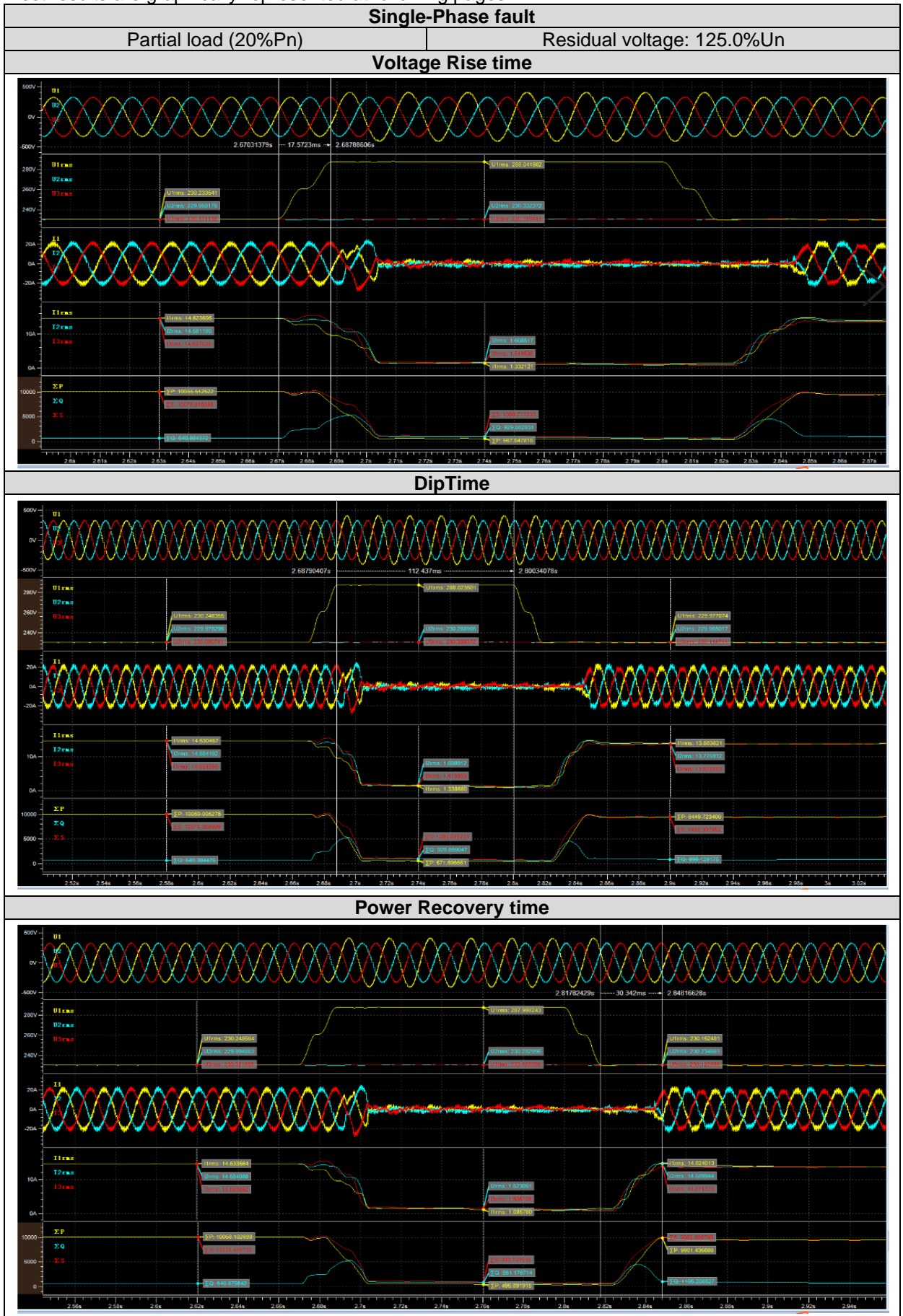

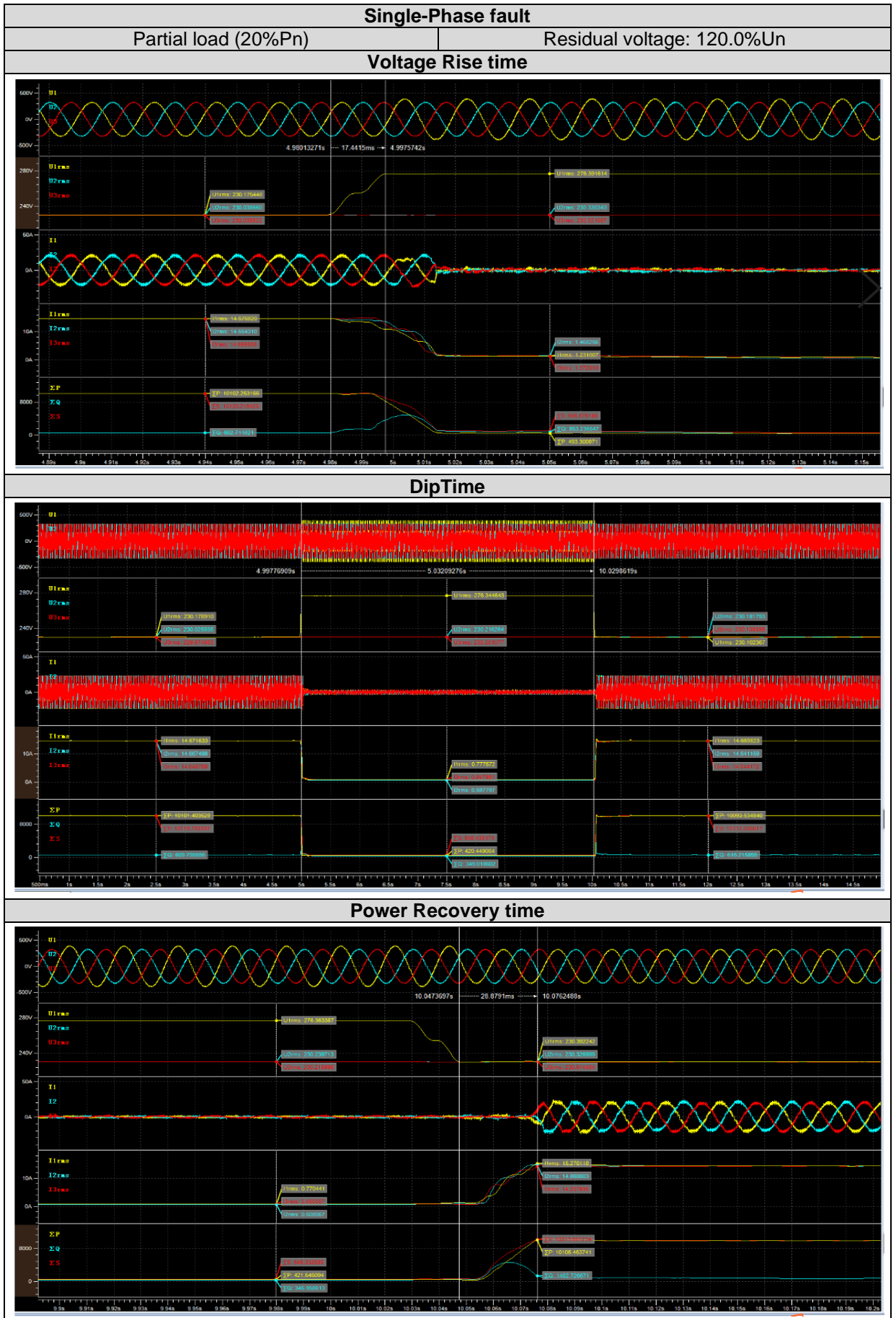

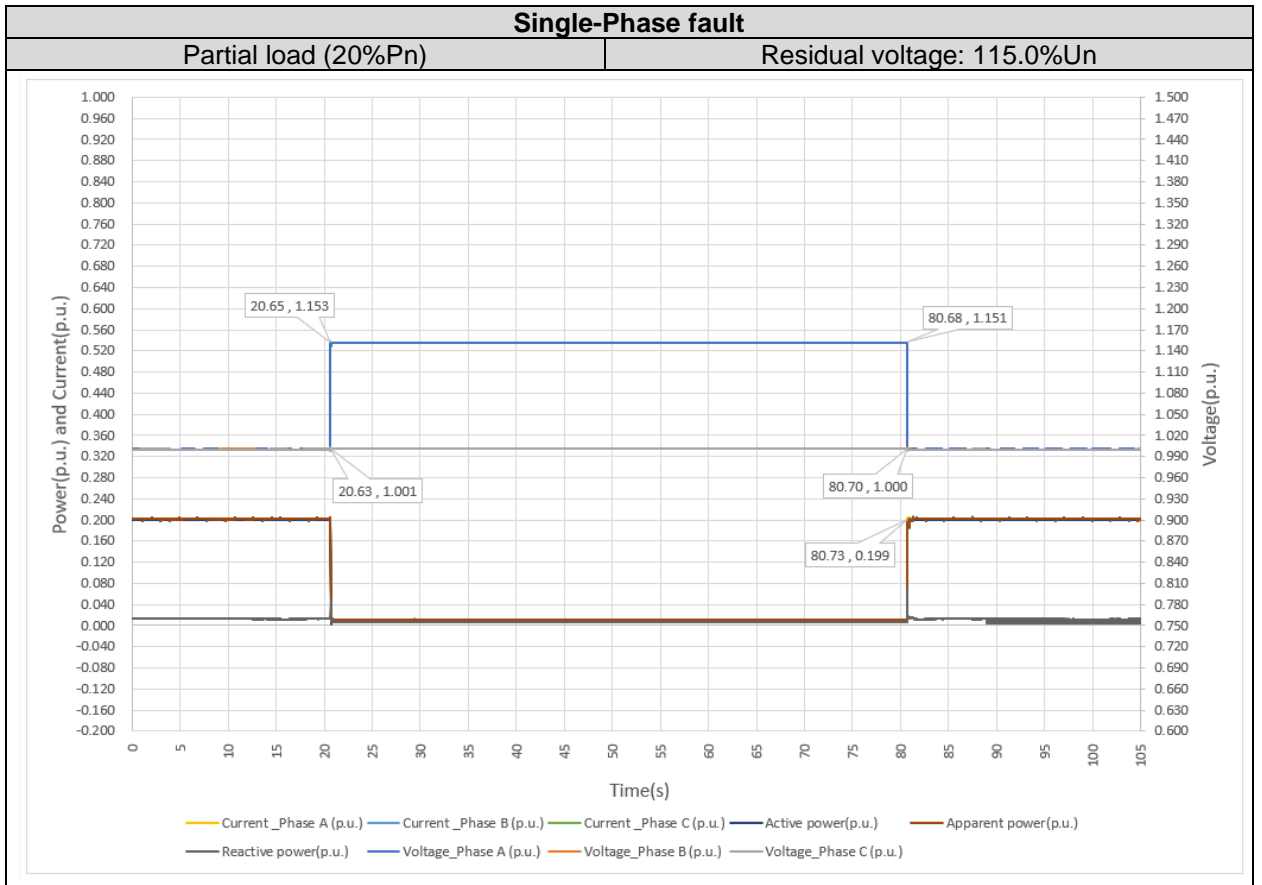

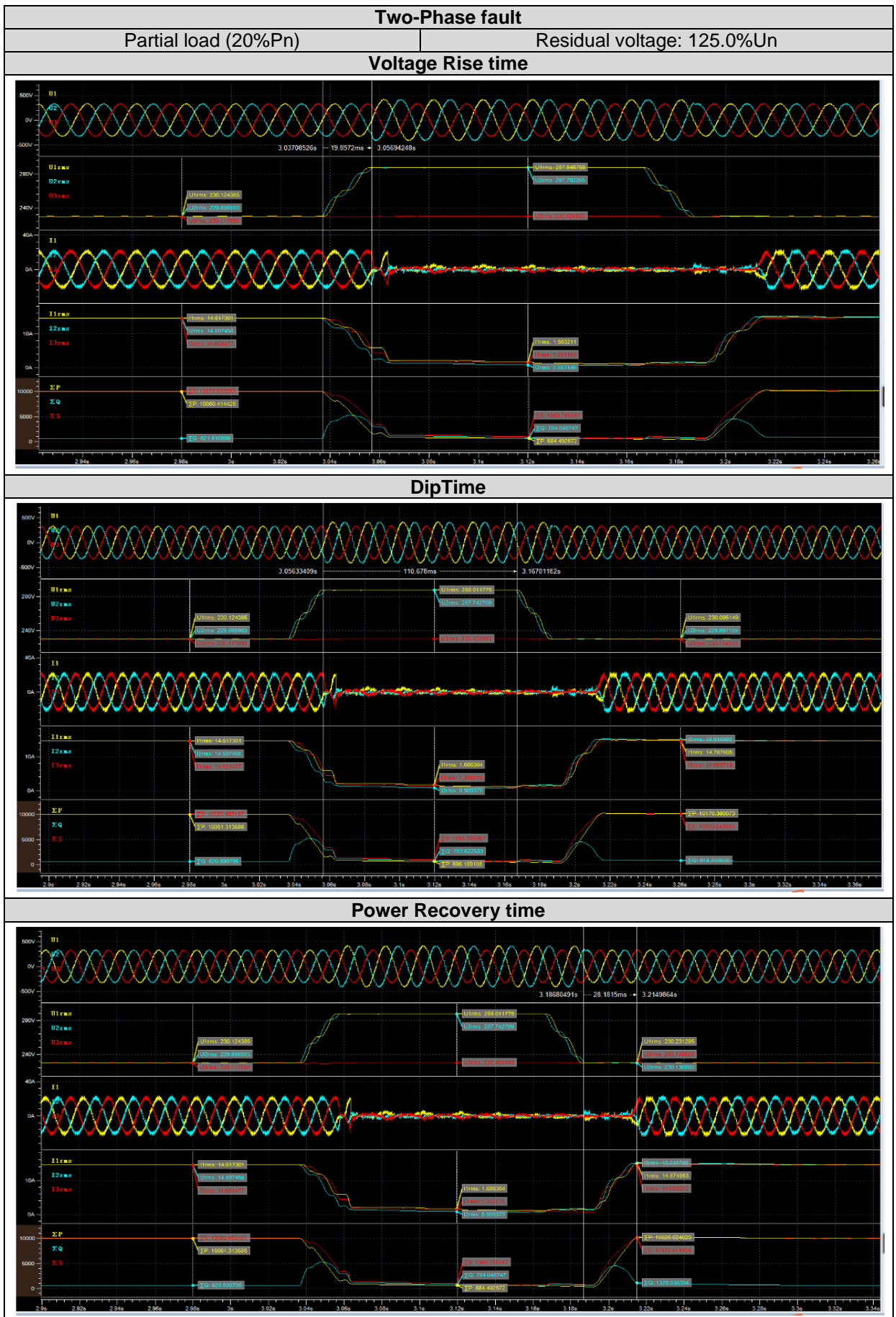

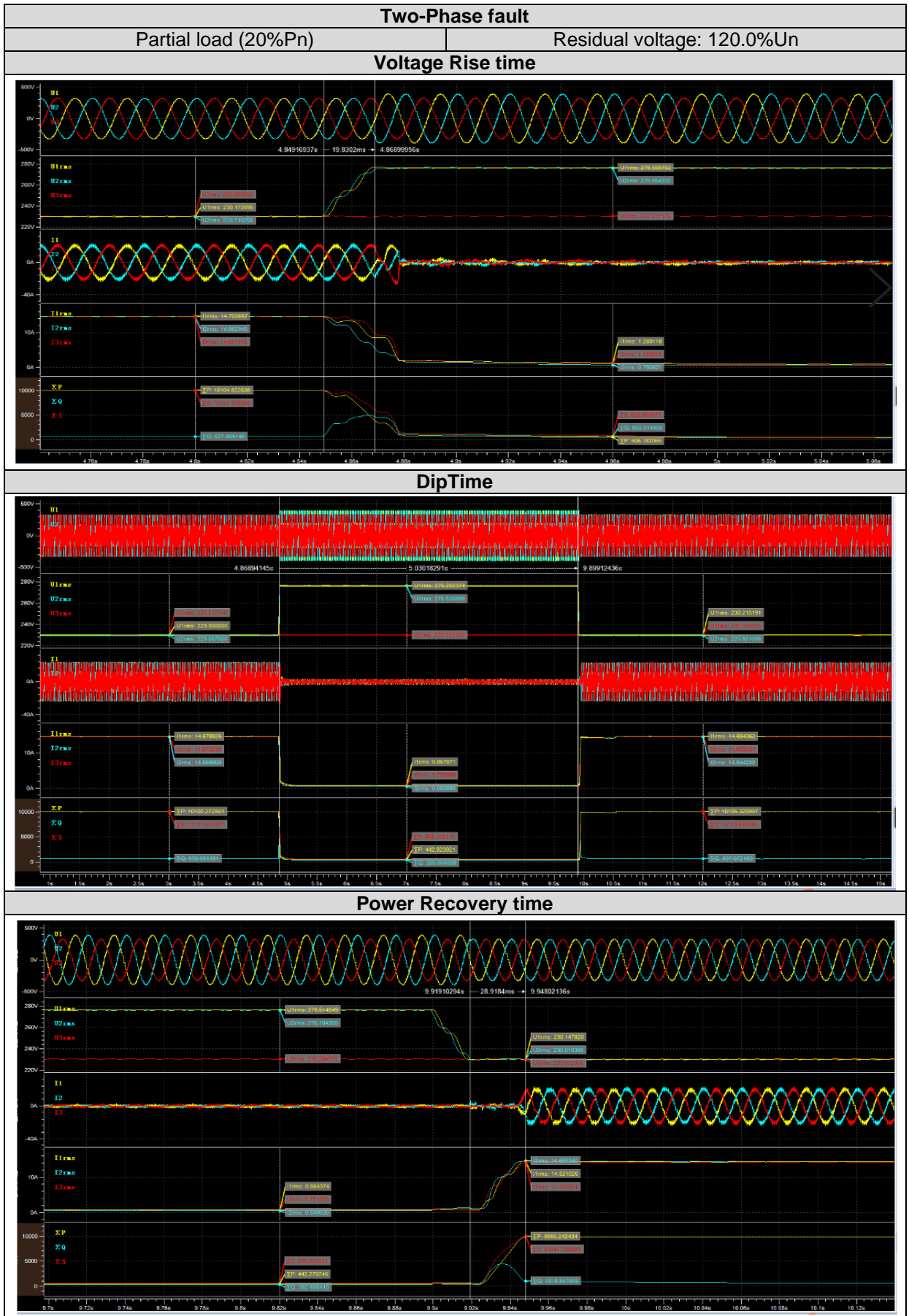



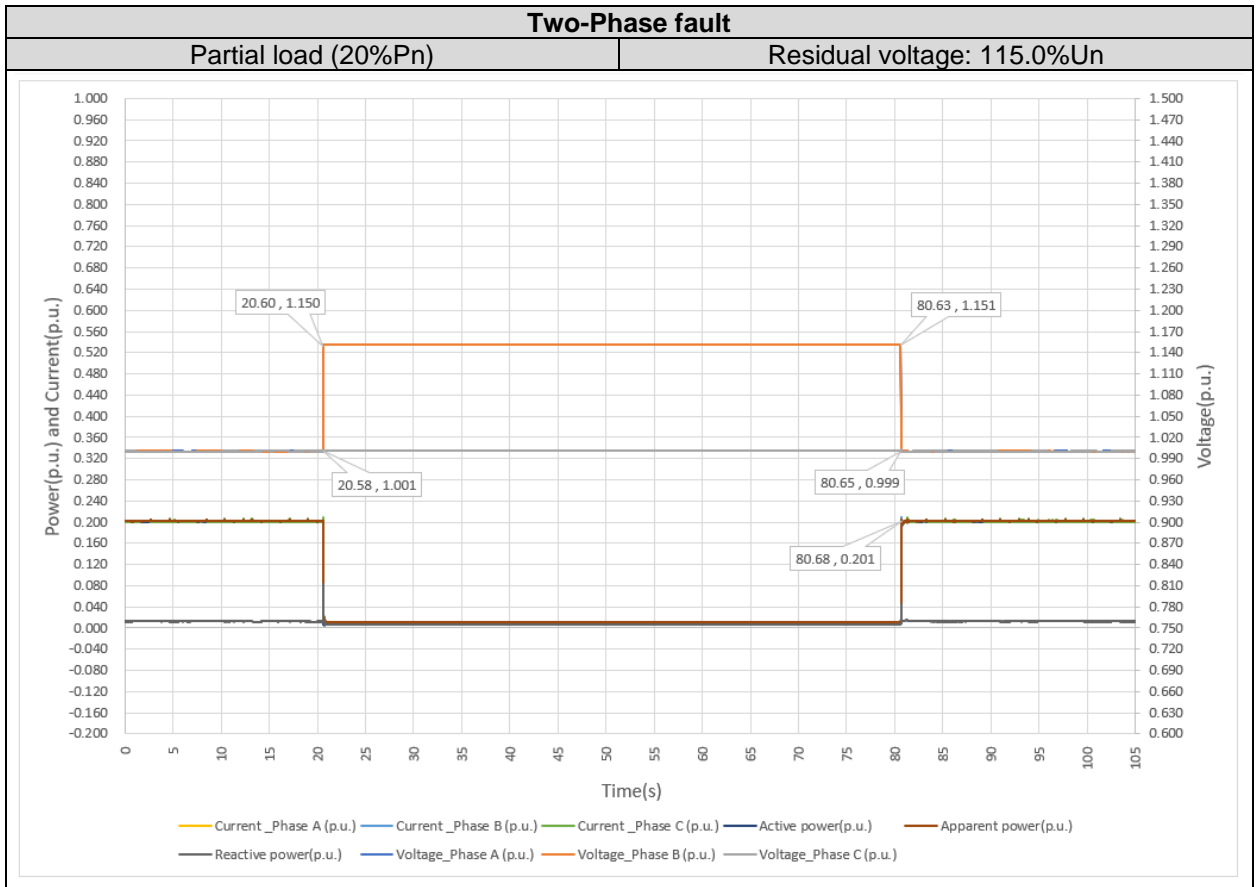

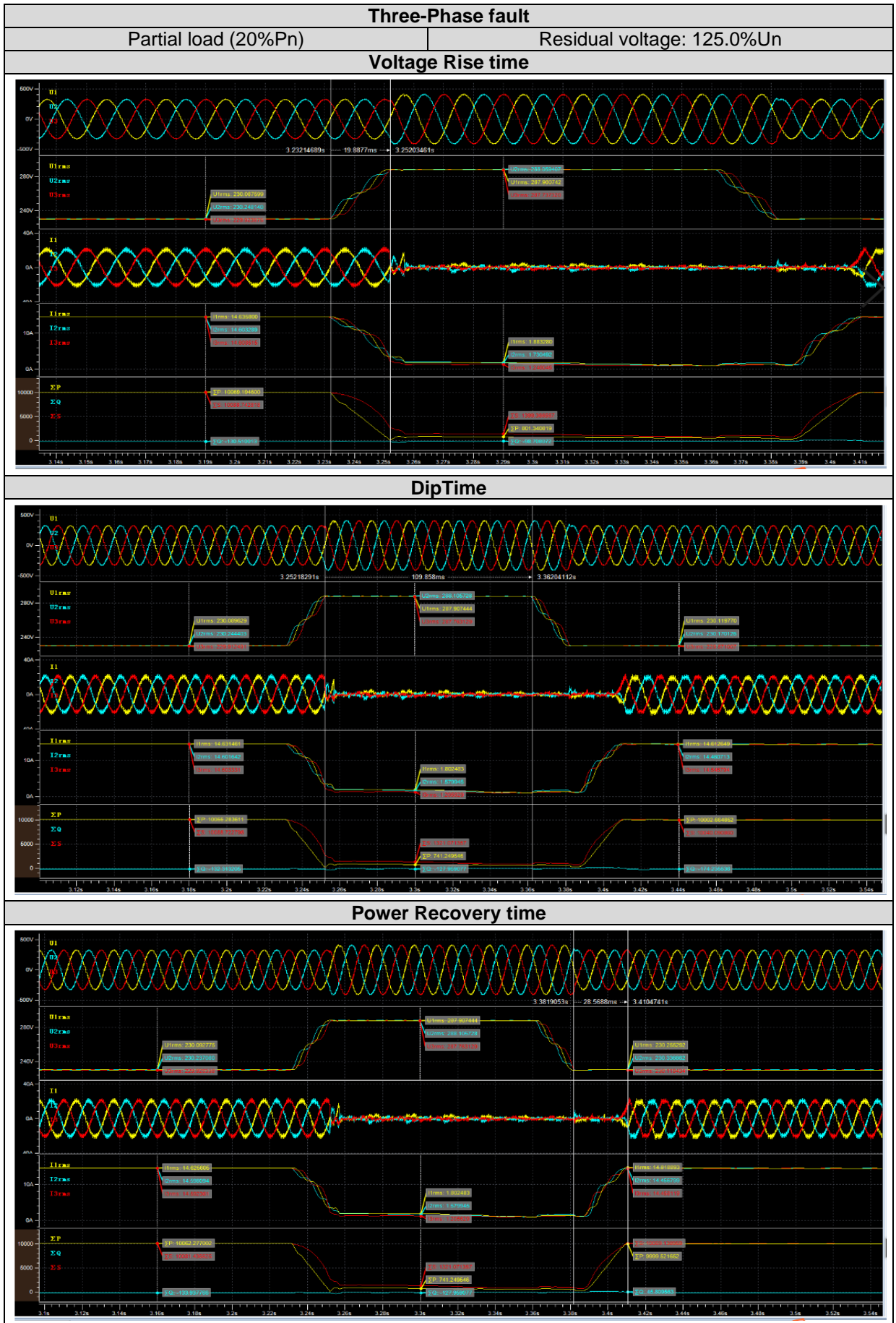

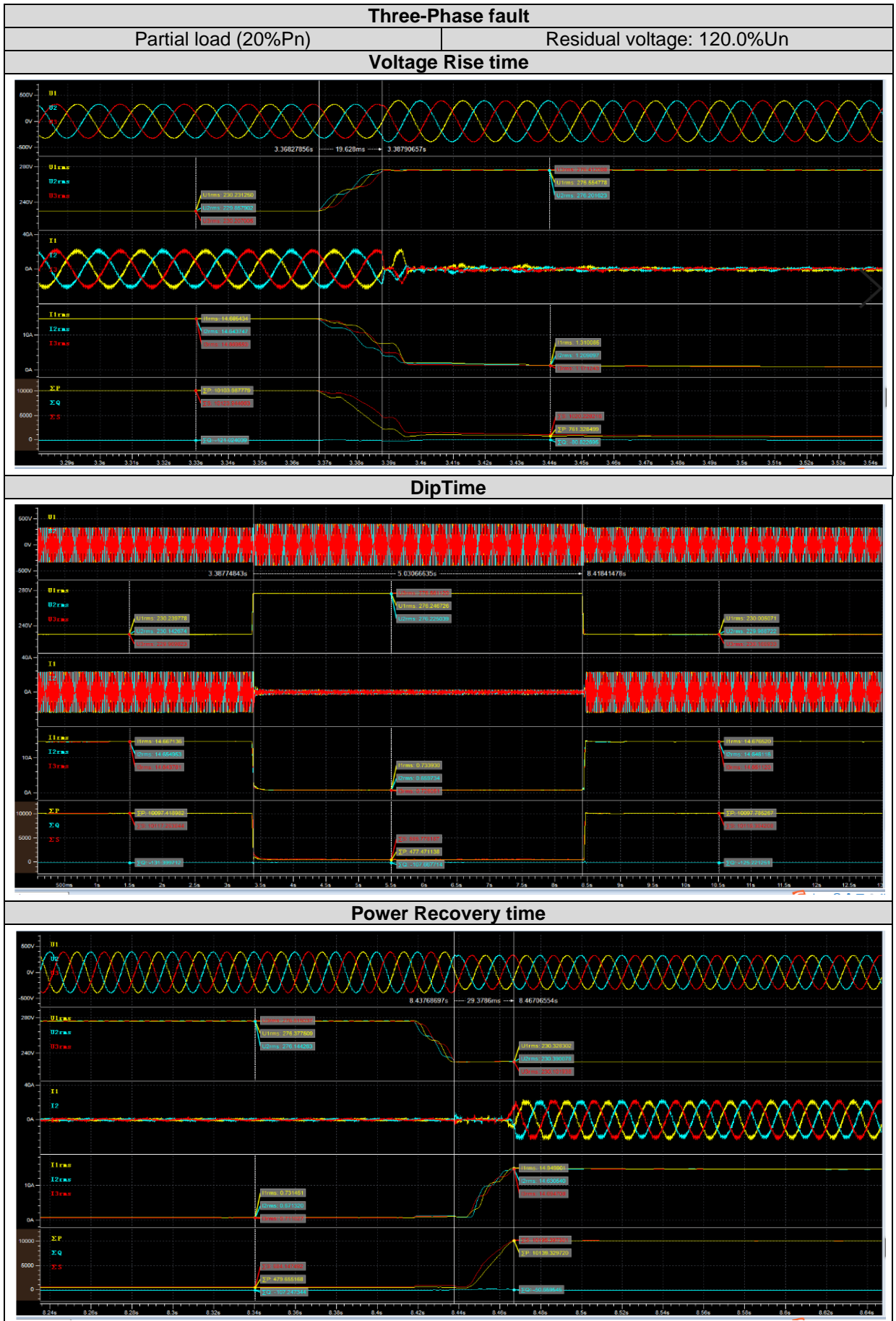

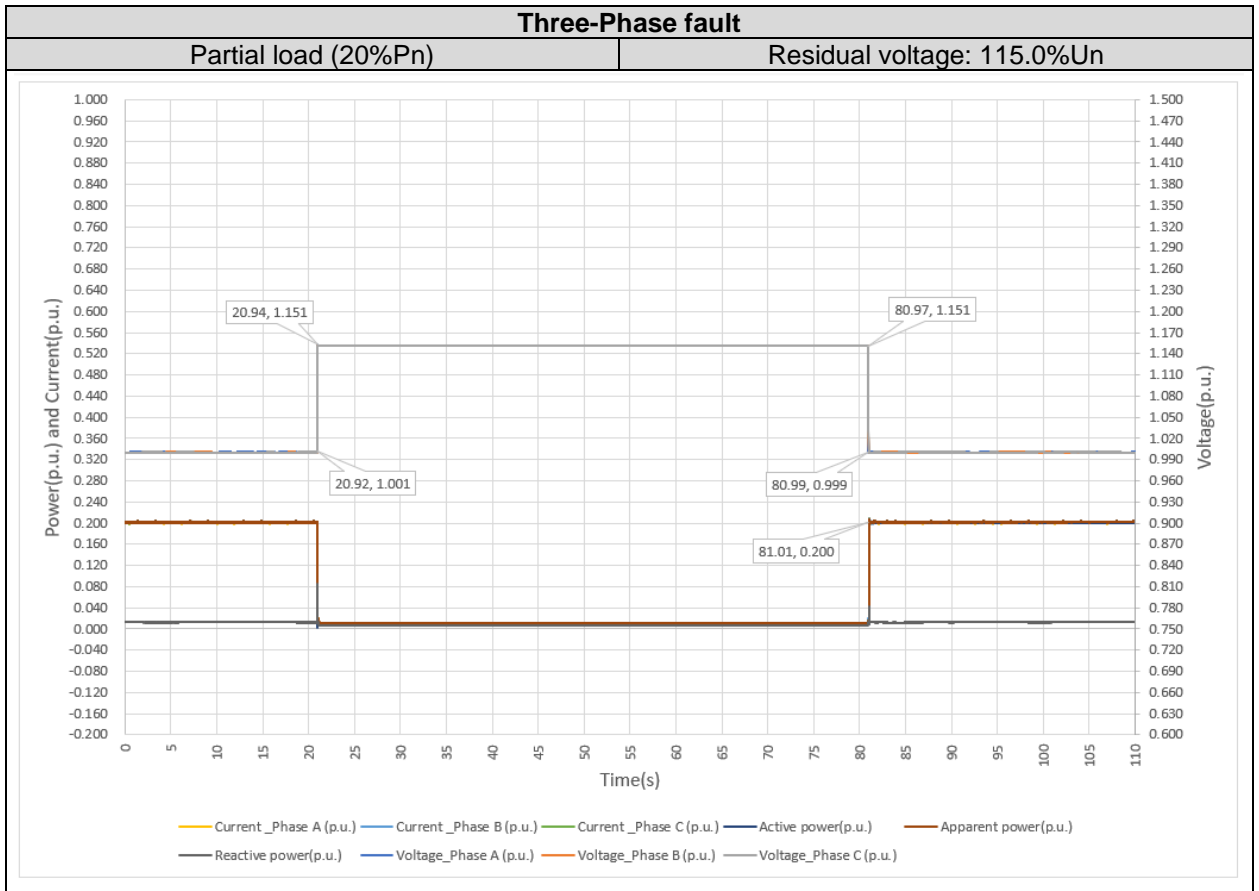

#### 4.2.3.2 Load Tests: Full Load (> 90 %Pn)

Test results of full power cases performed are offered below:

Single-Phase fault							
Residual voltage Desired (%Un)	Voltage before sag (%Un)	Voltage Rise time (ms)	Residual voltage Measured (%Un)	DipTime (ms)		Power Recovery time (ms)	Voltage after Recovery (%Un)
				Desired	Meas.		
125.0	100.3	18	125.2	> 100	112	63	100.2
120.0	100.1	18	120.3	> 5000	5032	54	100.2
115.0	100.2	20	115.6	> 60000	60030	60	99.8

Two-Phase fault							
Residual voltage Desired (%Un)	Voltage before sag (%Un)	Voltage Rise time (ms)	Residual voltage Measured (%Un)	DipTime (ms)		Power Recovery time (ms)	Voltage after Recovery (%Un)
				Desired	Meas.		
125.0	100.2	20	125.2	> 100	110	46	100.2
120.0	100.2	20	120.1	> 5000	5029	47	100.2
115.0	100.2	30	115.3	> 60000	60020	40	99.8

Three-Phase fault							
Residual voltage Desired (%Un)	Voltage before sag (%Un)	Voltage Rise time (ms)	Residual voltage Measured (%Un)	DipTime (ms)		Power Recovery time (ms)	Voltage after Recovery (%Un)
				Desired	Meas.		
125.0	100.2	20	125.2	> 100	110	45	100.3
120.0	100.2	20	120.2	> 5000	5030	45	100.3
115.0	100.2	20	115.1	> 60000	60030	40	99.8

Test results are graphically represented at following pages.

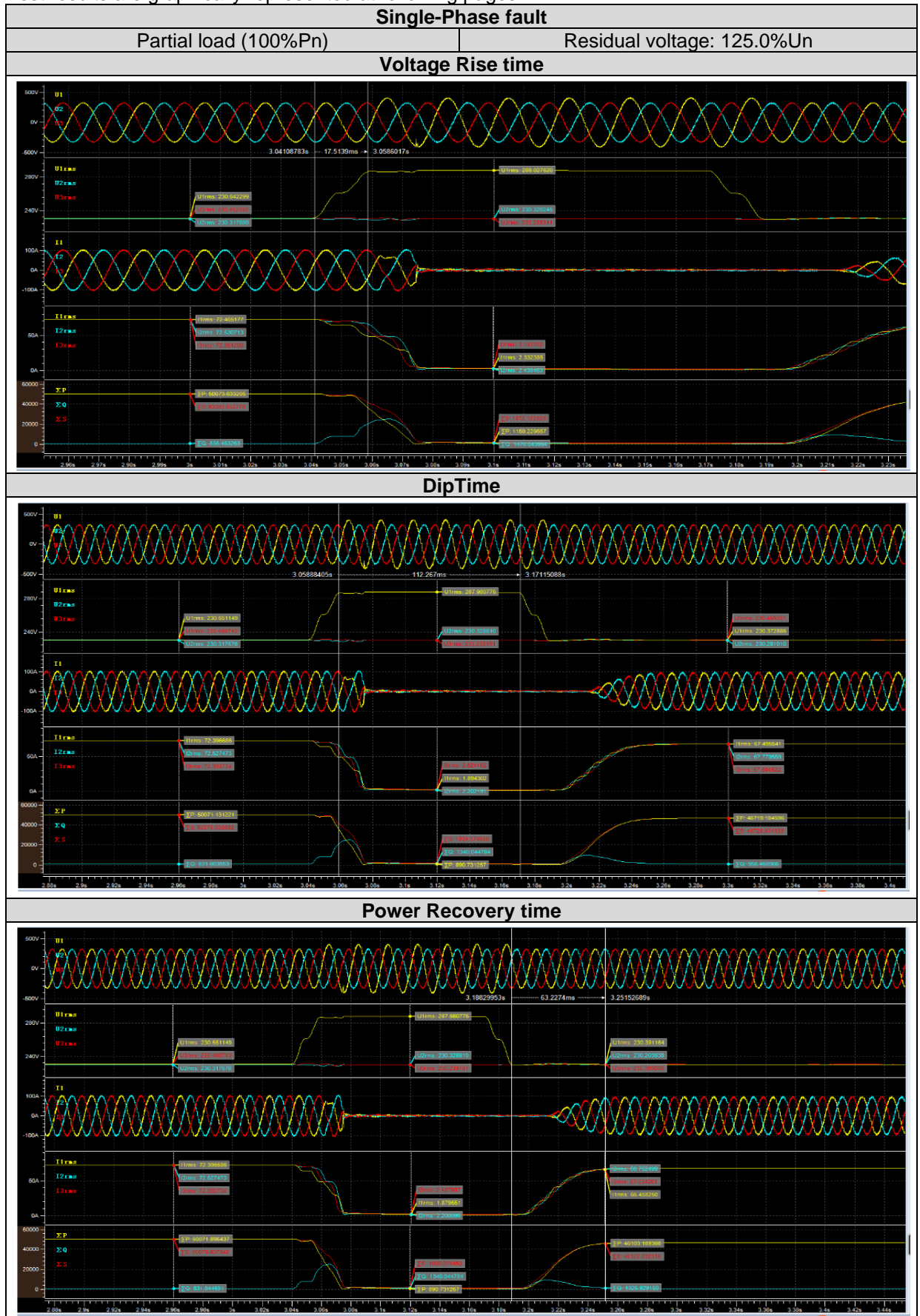

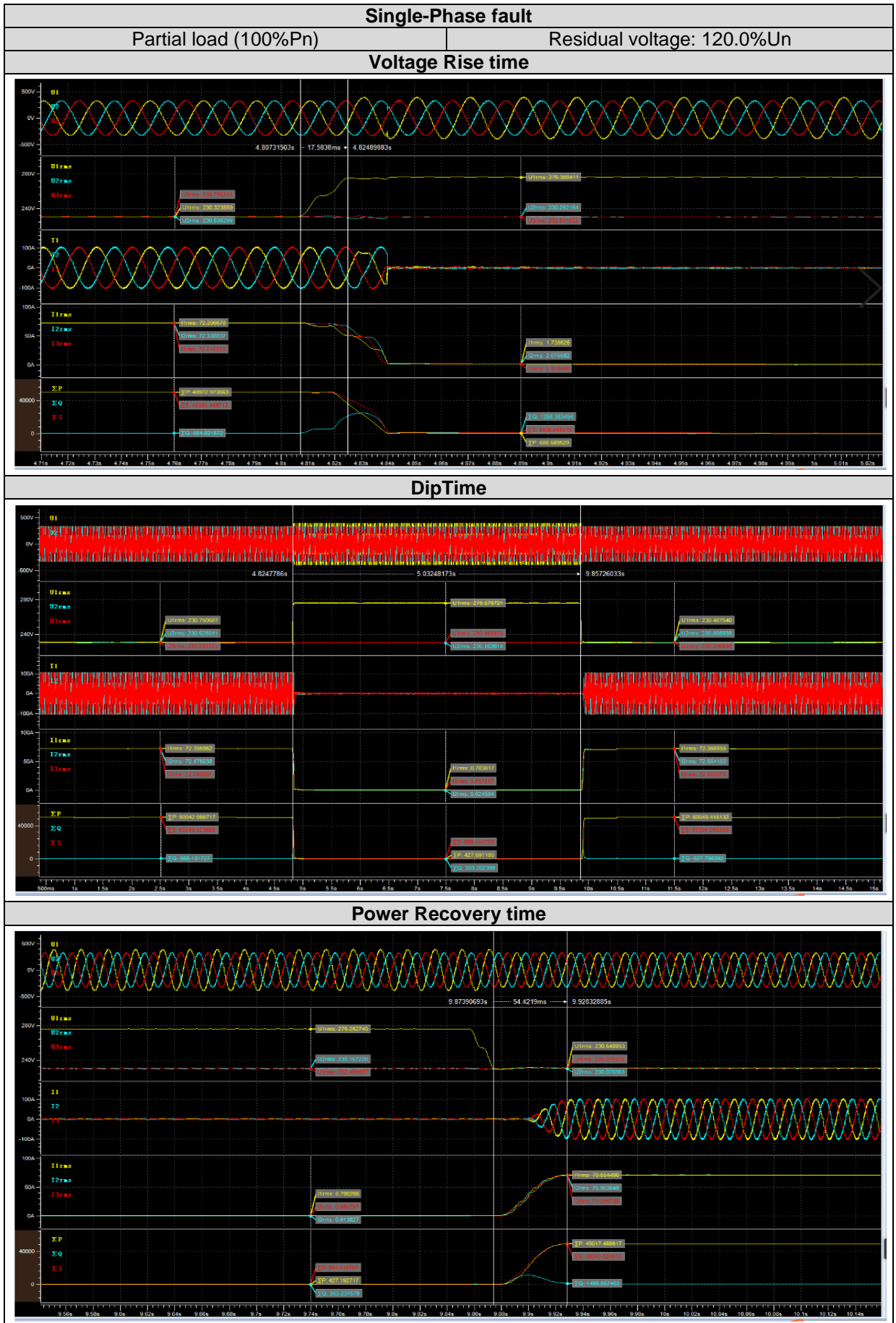

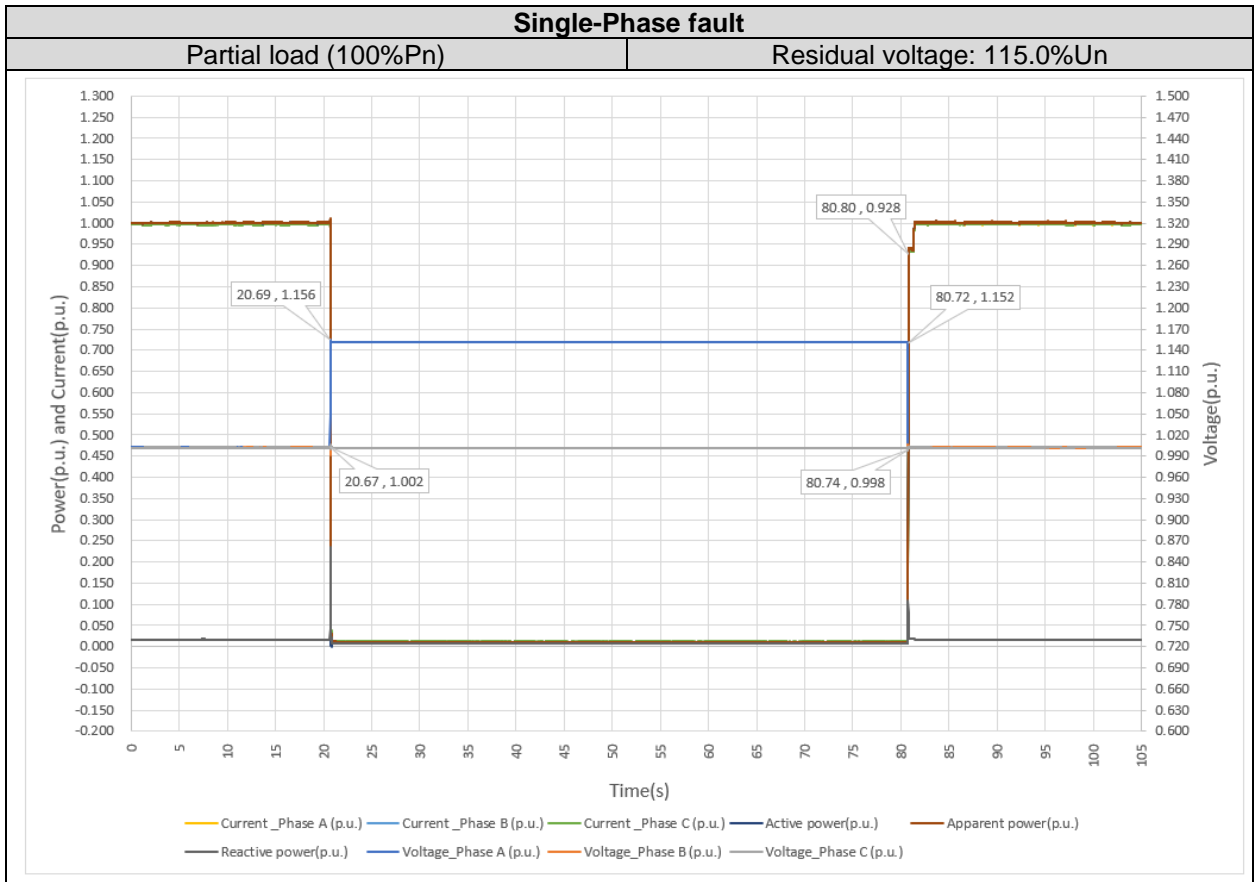



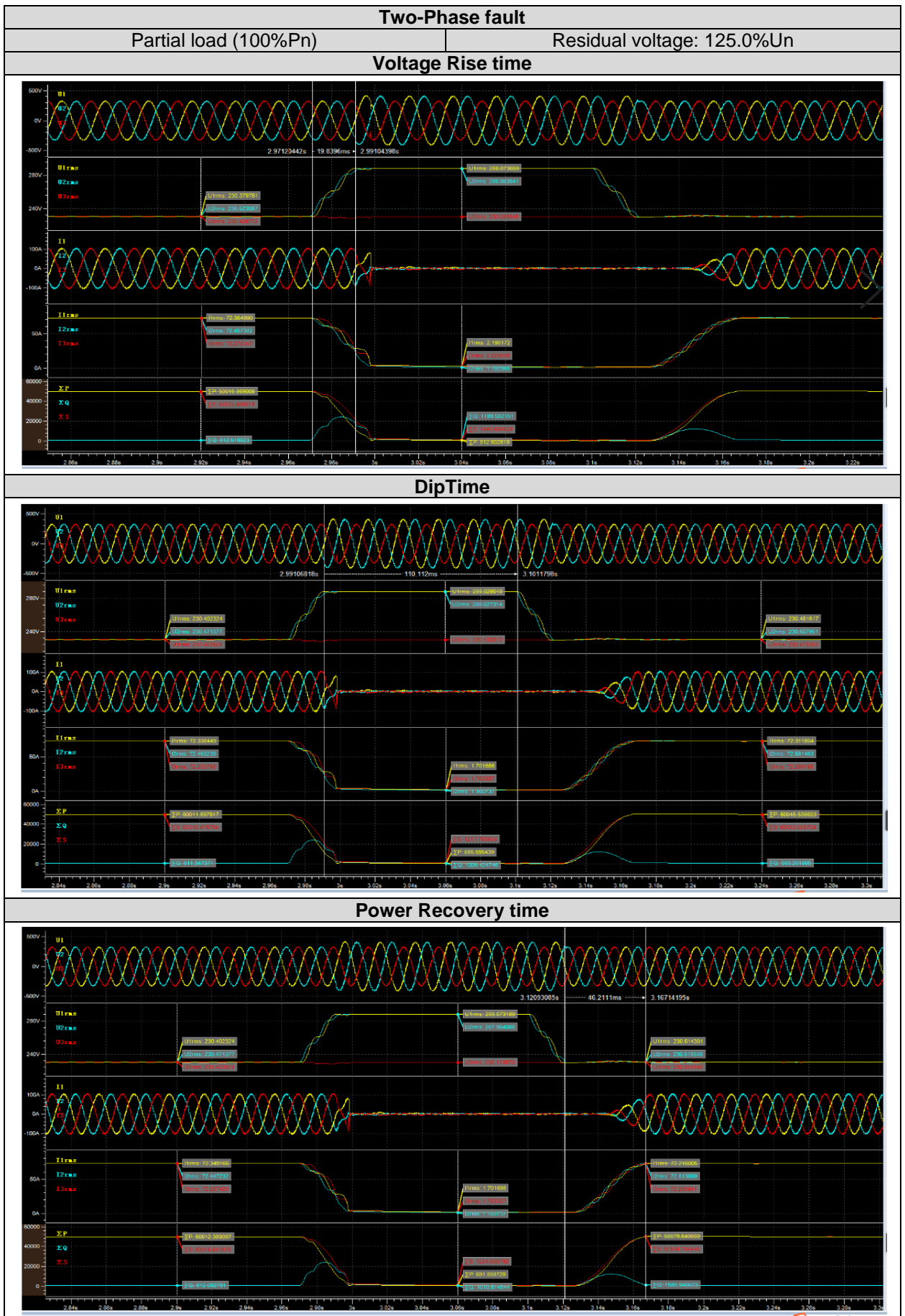

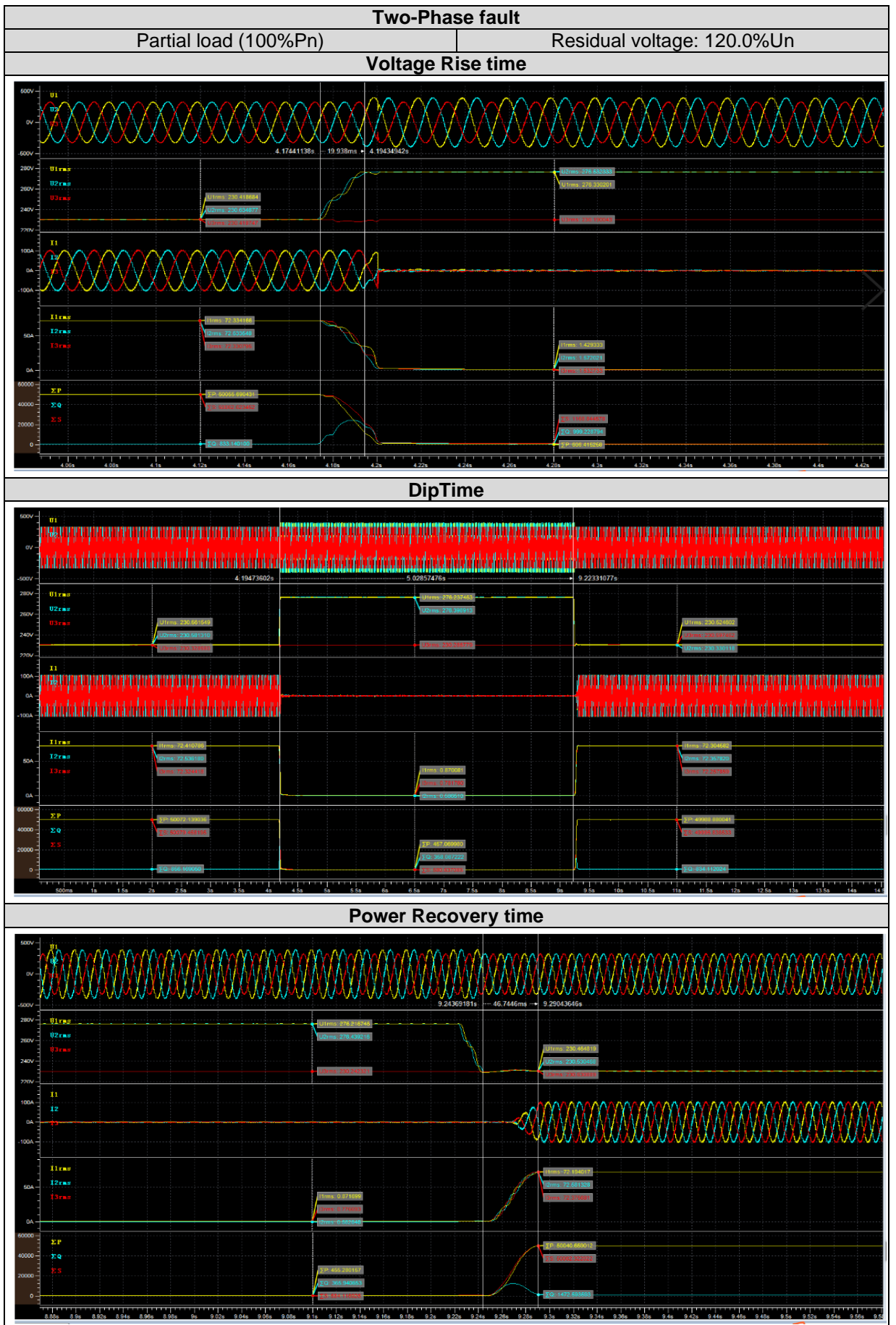

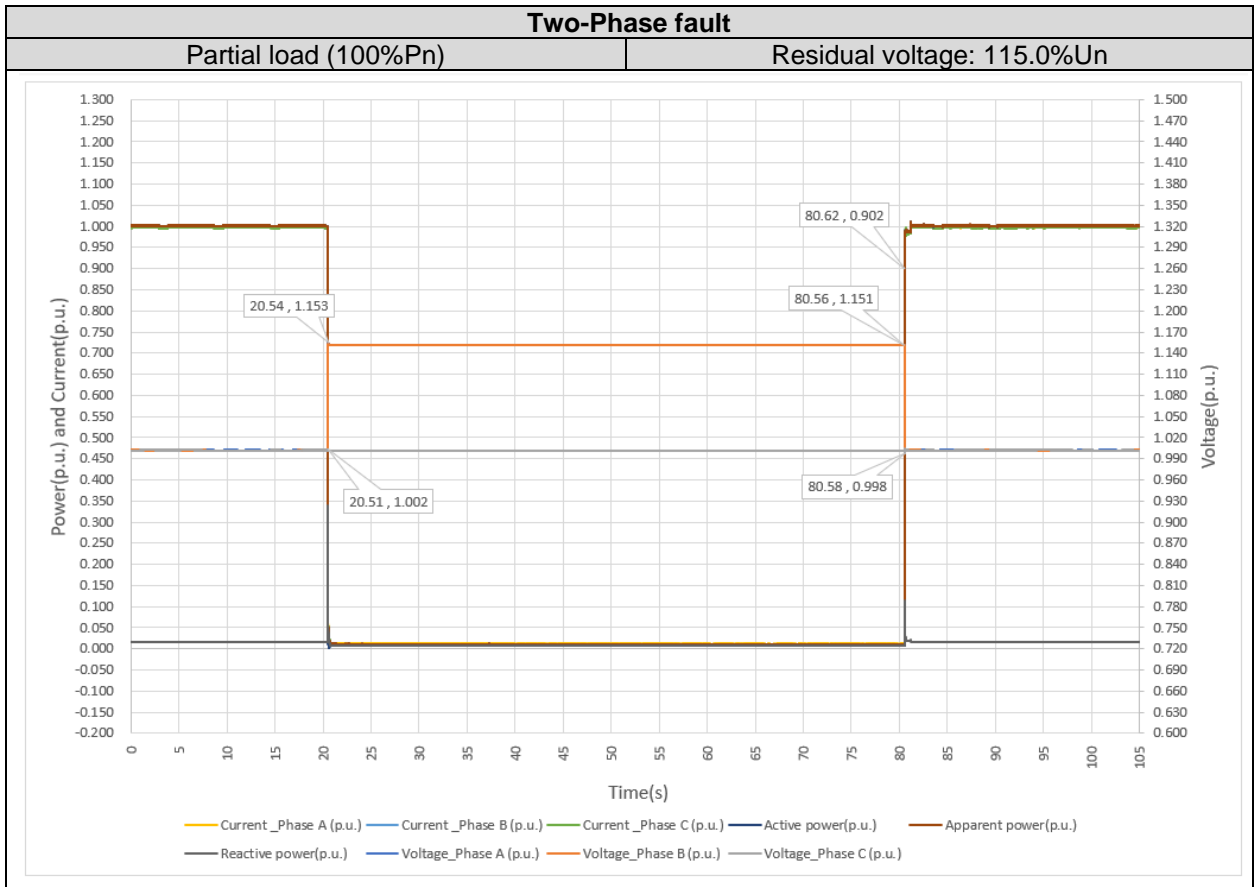

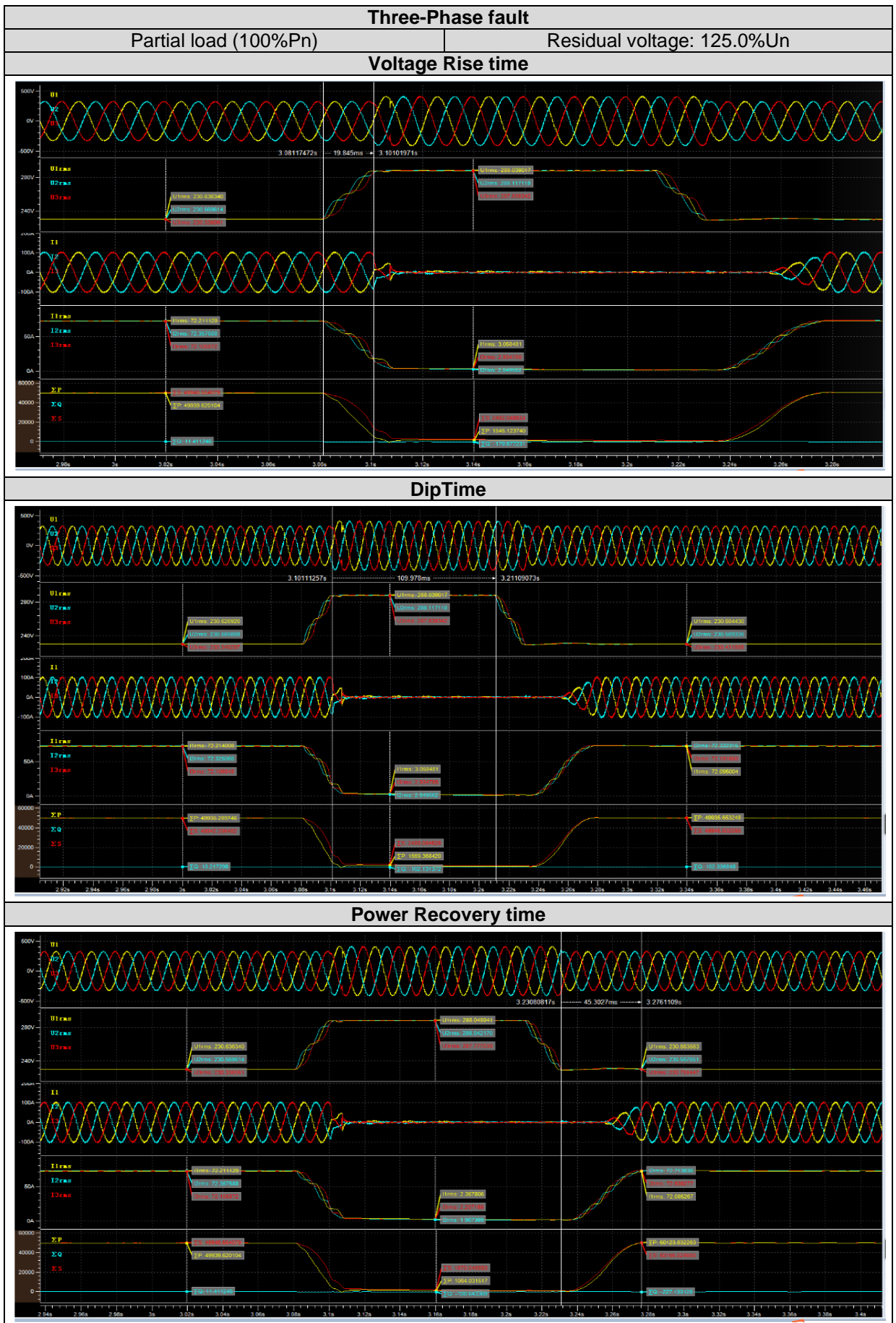

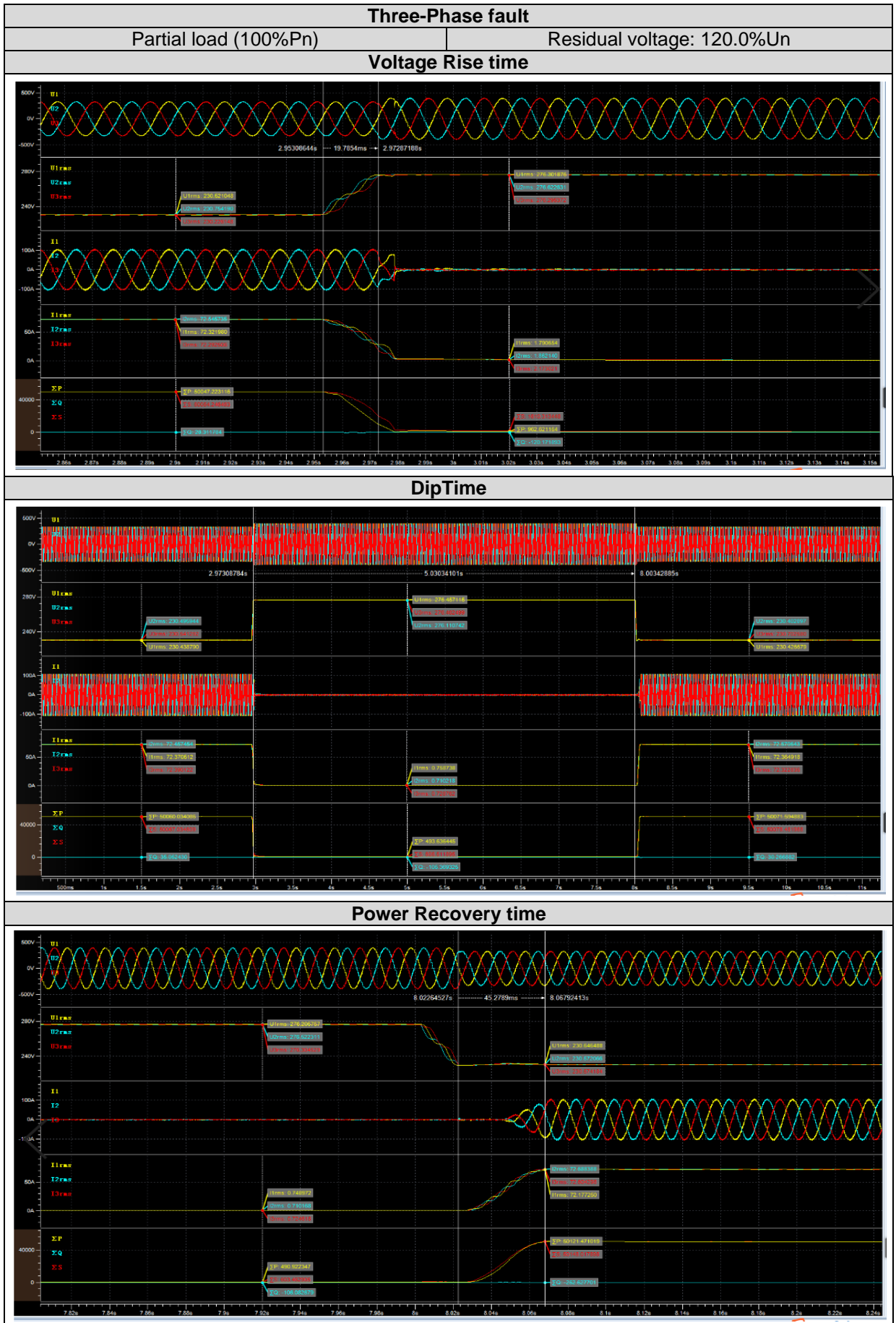

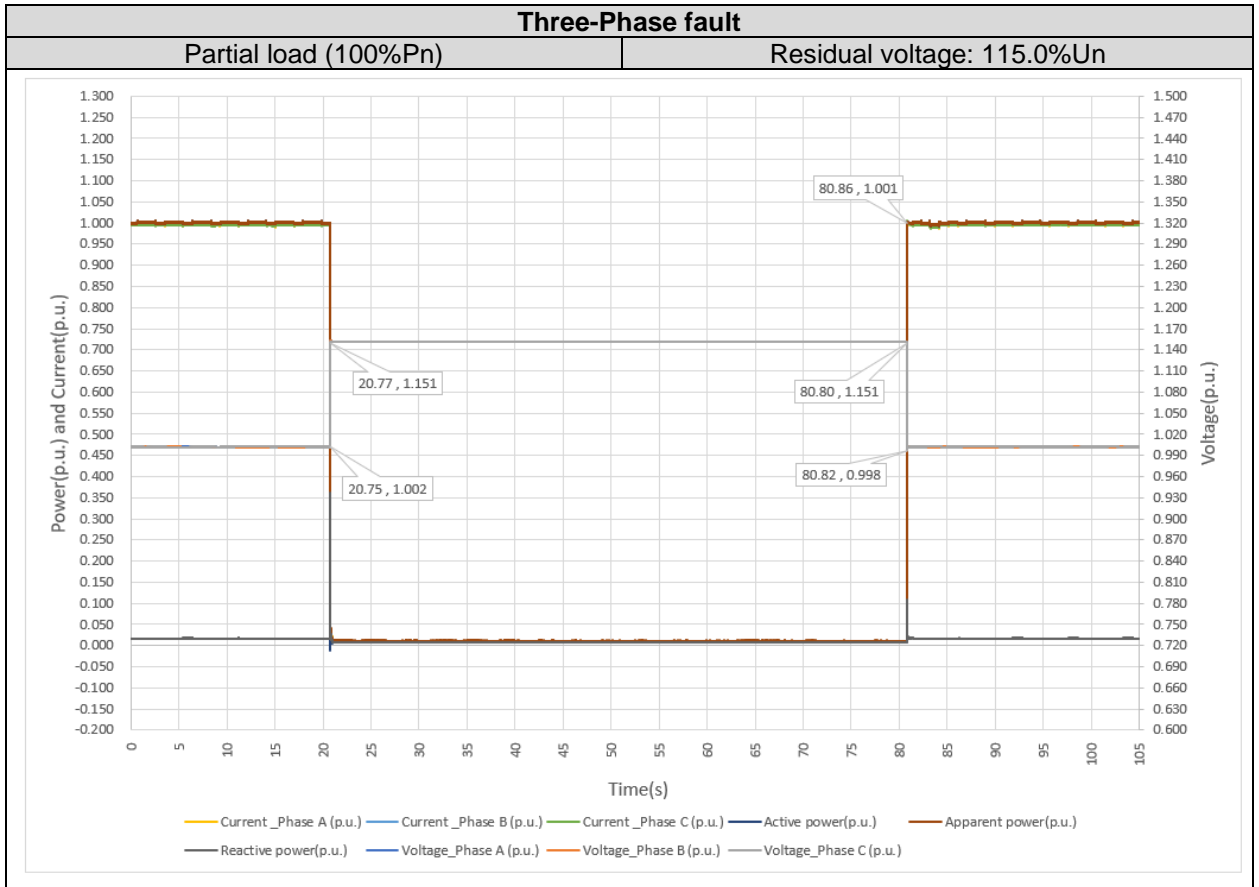

### 4.3. ACTIVE RESPONSE TO FREQUENCY DEVIATION

#### 4.3.1. Power response to overfrequency

The test has been done according to the clause 4.6.1 of the standard. The following definitions apply to the test to verify the clause:

- Test 1: P = 100 %P<sub>n</sub>; f1 = 50.2 Hz; droop = 12 %; f-stop deactivated, with delay of 2 s <sup>(1)</sup>
- Test 2: P = 100 %; f1 = 52.0 Hz; droop = 2 %; function deactivated
- Test 3: P = 50 %; f1 = 51.0 Hz; droop = 5 %; f-stop deactivated, no delay
- Test 4: P = 100 %, f1 = 50.2 Hz; droop = 5 %; f-stop = 50.1 Hz (hysteresis), no delay

<sup>(1)</sup> The intentional delay is only active for the activation of the function, once the function is operating, the established control loop is not intentionally delayed.

Note:

Threshold for disconnection overfrequency protection is set at 52.0 Hz at each test items.

Test results are offered at the table below.

Test 1					
Step	Frequency (Hz)	P desired (%Pn)	Frequency meas. (Hz)	P meas. (%Pn)	P deviation (%Pn) (within $\pm 10\%$ )
1	50.00 $\pm$ 0.05 Hz	100.0	50.00	100.0	0.0
2	50.20 $\pm$ 0.05 Hz	100.0	50.20	100.0	0.0
3	51.00 $\pm$ 0.05 Hz	86.7	51.00	86.4	-0.3
4	51.80 $\pm$ 0.05 Hz	73.3	51.80	72.6	-0.7
5	50.20 $\pm$ 0.05 Hz	100.0	50.20	99.8	-0.2
6	50.00 $\pm$ 0.05 Hz	100.0	50.00	100.1	+0.1
Time delay setting from step 2 to step 3					
Time reference of change (s)			240.6		
End of delay (s)			242.8		
Delay time (s)			2.2		
End of change (s)			243.0		
Change time (s)			0.2		

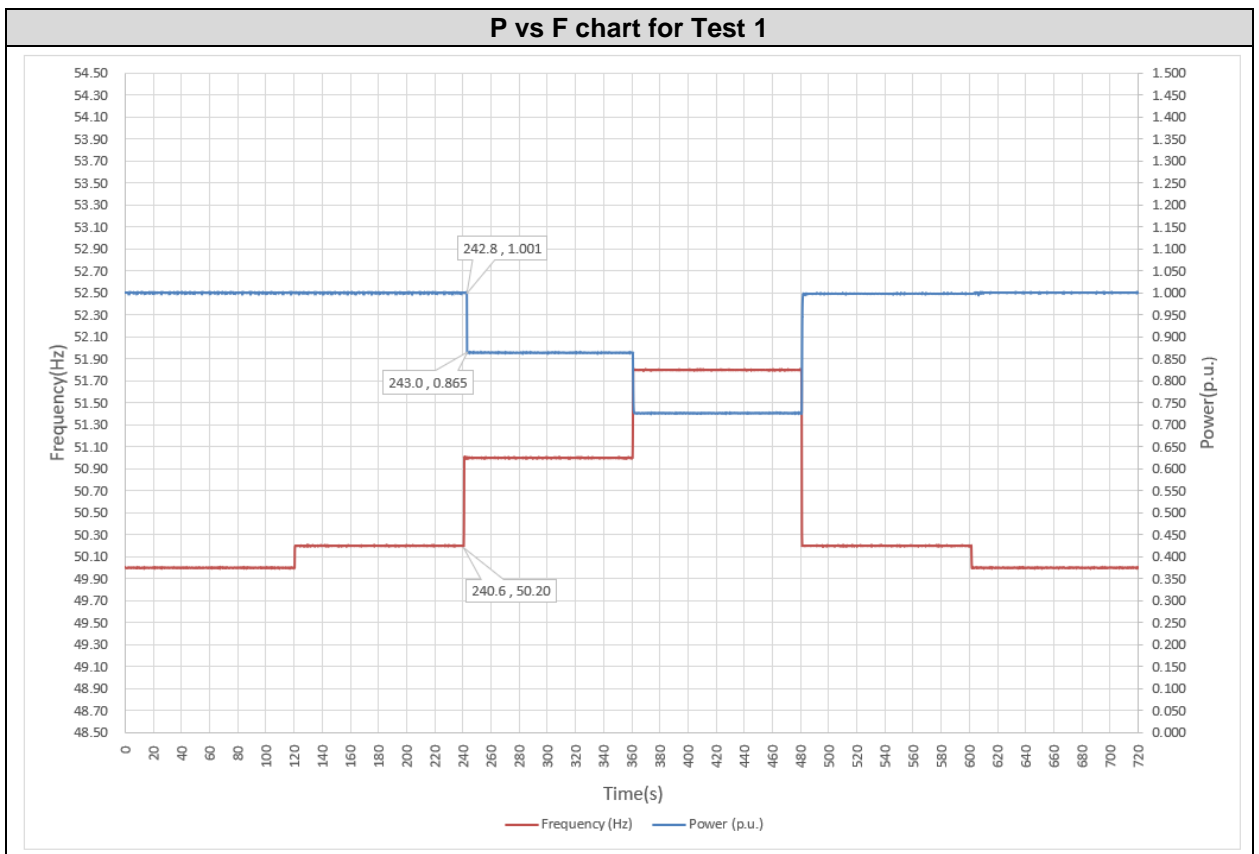



Test 2					
Step	f (Hz)	P desired (%Pn)	Frequency meas. (Hz)	P meas. (%Pn)	P deviation (%Pn) (within ±10 %)
1	50.00 ± 0.05 Hz	100.0	50.00	100.1	+0.1
2	50.50 ± 0.05 Hz	100.0	50.50	100.1	+0.1
3	51.00 ± 0.05 Hz	100.0	51.00	100.1	+0.1
4	51.50 ± 0.05 Hz	100.0	51.50	100.1	+0.1
5	51.80 ± 0.05 Hz	100.0	51.80	100.1	+0.1
6	52.20 ± 0.05 Hz	0.0	52.20	0.0	0.0

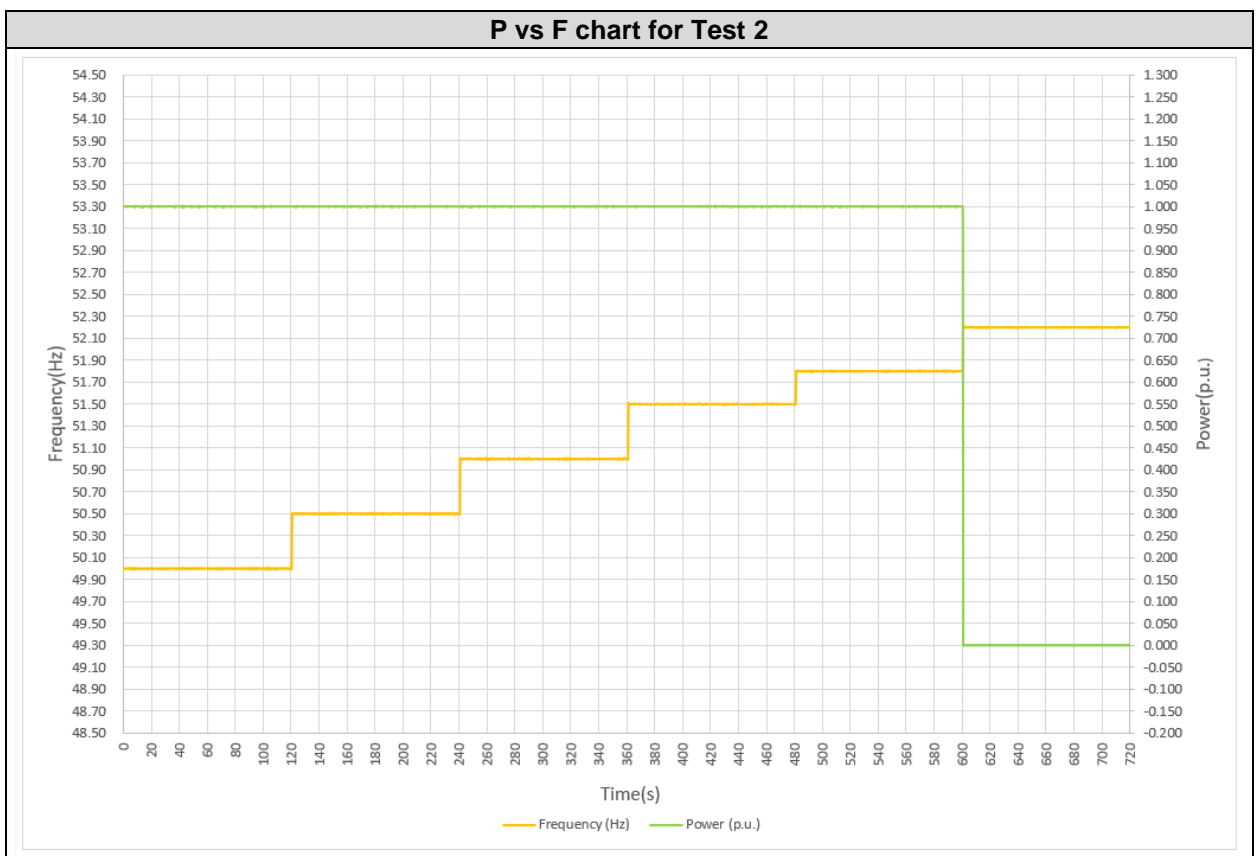

Test 3					
Step	Frequency (Hz)	P desired (%Pn)	Frequency meas. (Hz)	P meas. (%Pn)	P deviation (%Pn) (within $\pm 10\%$ )
1	50.00 $\pm$ 0.05 Hz	50.0	50.00	50.1	+0.1
2	51.00 $\pm$ 0.05 Hz	50.0	51.00	50.1	+0.1
3	51.20 $\pm$ 0.05 Hz	46.0	51.20	46.3	+0.3
4	51.70 $\pm$ 0.05 Hz	36.0	51.70	36.4	+0.4
5	51.30 $\pm$ 0.05 Hz	44.0	51.30	44.4	+0.4
6	51.00 $\pm$ 0.05 Hz	50.0	51.00	49.9	-0.1
7	50.00 $\pm$ 0.05 Hz	50.0	50.00	50.1	+0.1
Time delay setting from step 2 to step 3					
Time reference of change (s)			242.2		
End of delay (s)			242.4		
Delay time (s)			0.2		
End of change (s)			243.4		
Change time (s)			1.0		

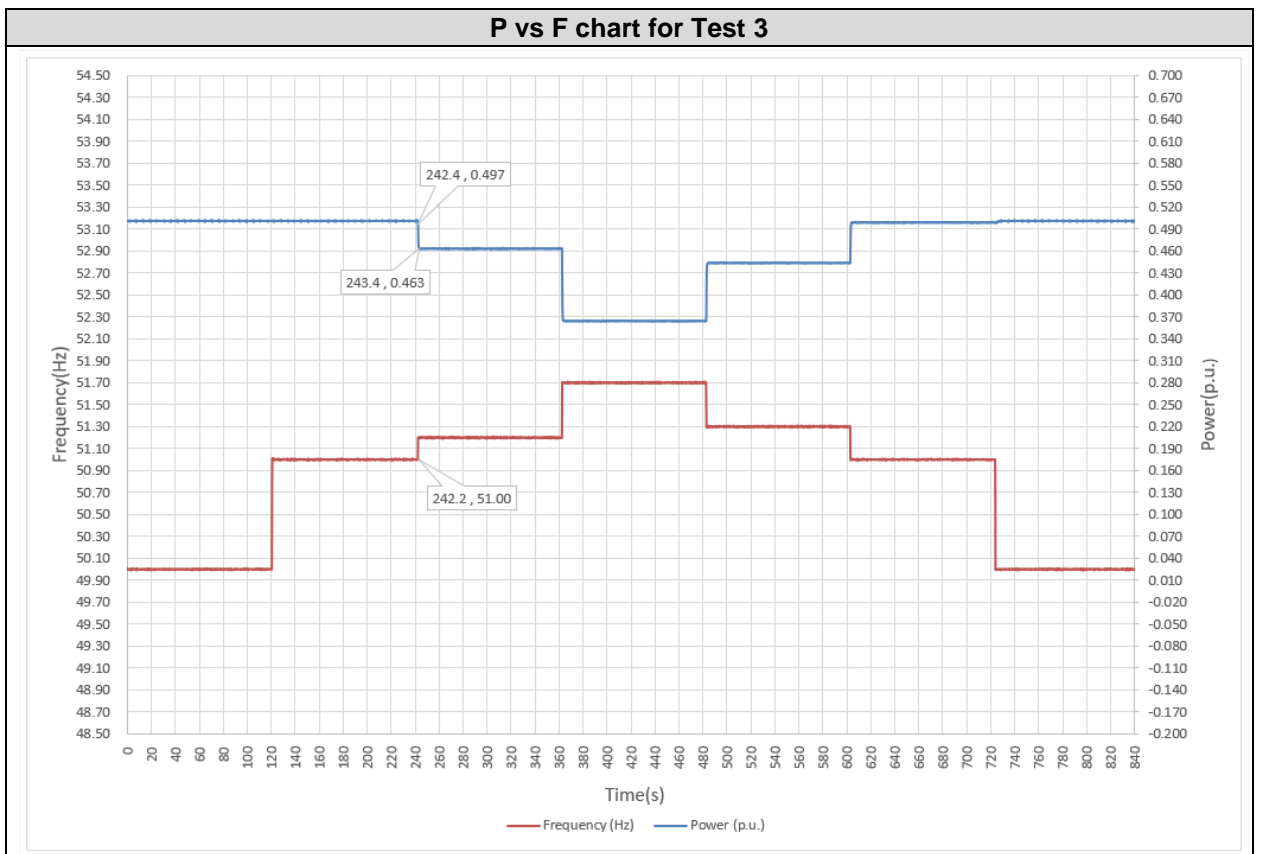

Test 4					
Step	Frequency (Hz)	P desired (%Pn)	Frequency meas. (Hz)	P meas. (%Pn)	P deviation (%Pn) (within ±10 %)
1	50.00 ± 0.05 Hz	100.0	50.00	100.0	0.0
2	50.20 ± 0.05 Hz	100.0	50.20	100.0	0.0
3	51.00 ± 0.05 Hz	68.0	51.00	67.9	-0.1
4	50.30 ± 0.05 Hz	68.0	50.30	67.9	-0.1
5	51.00 ± 0.05 Hz	68.0	51.00	67.9	-0.1
6	52.00 ± 0.05 Hz	28.0	52.00	27.3	-0.7
7	51.00 ± 0.05 Hz	28.0	51.00	27.3	-0.7
8	50.50 ± 0.05 Hz	28.0	50.50	27.3	-0.7
9	50.20 ± 0.05 Hz	28.0	50.20	27.3	-0.7
10	50.00 ± 0.05 Hz	100.0	50.00	100.1	+0.1
Time delay setting from step 2 to step 3					
Time reference of change (s)			241.0		
End of delay (s)			241.0		
Delay time (s)			0.0		
End of change (s)			242.0		
Change time (s)			0.6		
Recovery Time (s)			600.4		
Power ramp gradient (%Pn/min)			+8.1		

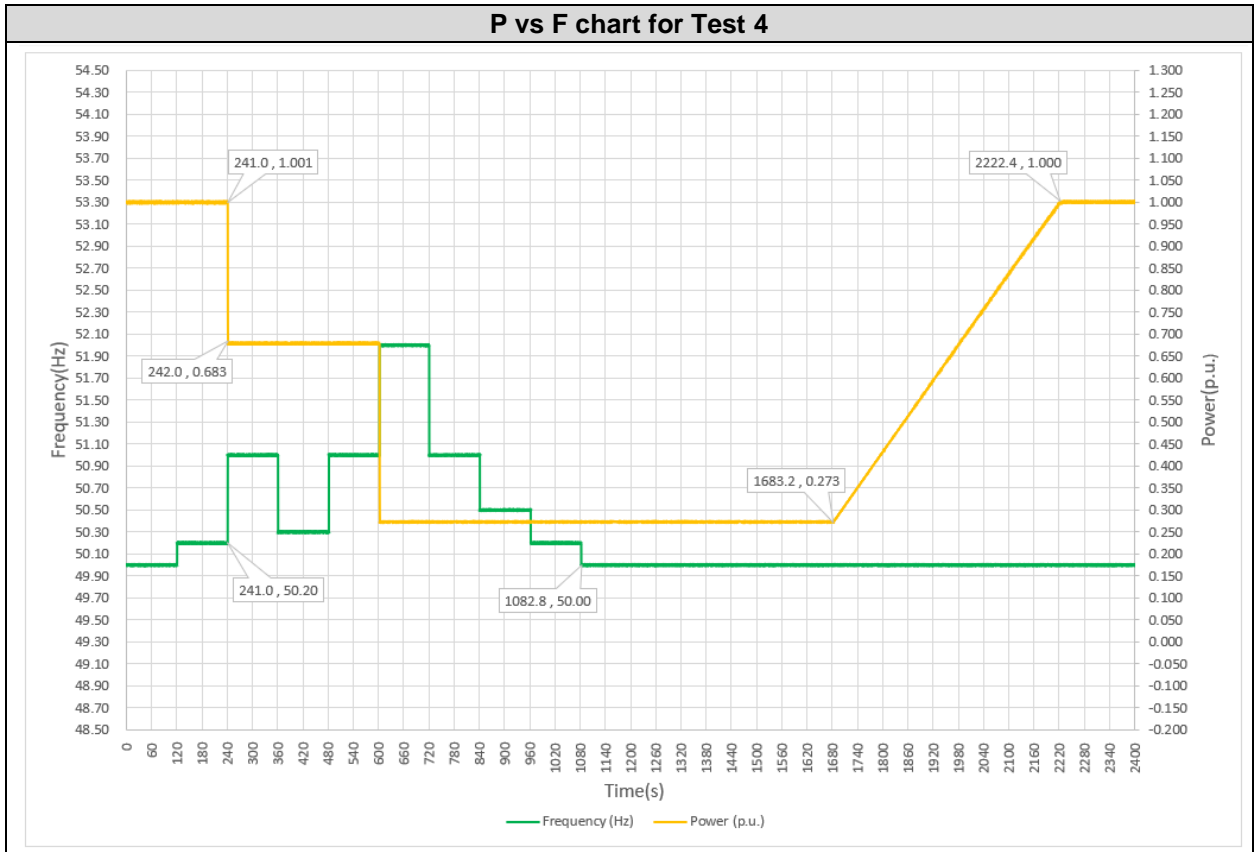

#### 4.3.2. Power response to underfrequency

This test has not been performed to show the capability of the inverter, because it is only mandatory for Energy Storage Systems according to the clause 4.6.2 of the standard.

#### 4.4. POWER RESPONSE TO VOLTAGE CHANGES

The generating unit shall be capable of operating in the control modes specified below within the limits specified in 4.7.2.2. The control modes are exclusive, only one mode may be active at a time.

- Q setpoint mode
- Q (U)
- Cos  $\varphi$  setpoint mode
- Cos  $\varphi$  (P)

##### 4.4.1. Setpoint control modes

The test has been done according to the clause 4.7.2.3.2 of the standard. The following definitions apply to the test to verify the clause:

- Test 1: Q Zero ( $Q = 0 \% P_D$ )
- Test 2: Rectangular Curve ( $Q = \pm 48.4 \% S_n = \pm 48.4 \% P_D$ )
- Test 3: Triangular Curve ( $PF = \pm 0.8$ )
- Test 4: Reactive power capability at active power  $P_D$  in the voltage range ( $0.85U_n \sim 1.1U_n$ )

**4.4.1.1. Test 1: Q Zero (Q = 0 % P<sub>D</sub>)**

This test verifies the capability of the inverter to provide a fixed value of reactive power. In addition, it is verified the Q control mode.

When the measurement is equal to or greater than 10% S<sub>n</sub>, the allowable tolerance of reactive power measurement should be within  $\pm 2\%$  S<sub>max</sub> or  $\pm 2.2\%$  P<sub>D</sub>.

Test results are offered at tables below.

<b>Rectangular Curve (Q=0% P<sub>D</sub>)</b>					
<b>P Desired (%S<sub>n</sub>)</b>	<b>P measured (%S<sub>n</sub>)</b>	<b>Q desired (%P<sub>D</sub>)</b>	<b>Q measured (%P<sub>D</sub>)</b>	<b>Q deviation (<math>\pm 2.2\%</math> P<sub>D</sub>)</b>	<b>Power Factor (cos <math>\phi</math>)</b>
<b>0.0<sup>(1)</sup></b>	1.1	<b>0.0</b>	-0.6	--	0.828
<b>10.0</b>	10.1	<b>0.0</b>	-1.2	-1.2	0.993
<b>20.0</b>	20.1	<b>0.0</b>	-1.2	-1.2	0.998
<b>30.0</b>	30.2	<b>0.0</b>	-1.2	-1.2	0.999
<b>40.0</b>	40.1	<b>0.0</b>	-0.4	-0.4	1.000
<b>50.0</b>	50.1	<b>0.0</b>	-0.2	-0.2	1.000
<b>60.0</b>	60.2	<b>0.0</b>	-0.4	-0.4	1.000
<b>70.0</b>	70.2	<b>0.0</b>	+0.1	+0.1	1.000
<b>80.0</b>	80.1	<b>0.0</b>	+0.5	+0.5	1.000
<b>90.0</b>	90.0	<b>0.0</b>	+0.5	+0.5	1.000
<b>100.0</b>	100.1	<b>0.0</b>	+0.6	+0.6	1.000
<b>110.0</b>	110.1	<b>0.0</b>	+0.7	+0.7	1.000

(<sup>1</sup>) The reactive power accuracy is  $\pm 2\%$  S<sub>max</sub>, which is not suitable for power below 10% P<sub>n</sub>.

Note: P is with respect to S<sub>n</sub> , Q is according to measured P<sub>D</sub>  $\approx$  1.0 P<sub>n</sub> (49.759 kW)

Test results are represented at diagrams below.

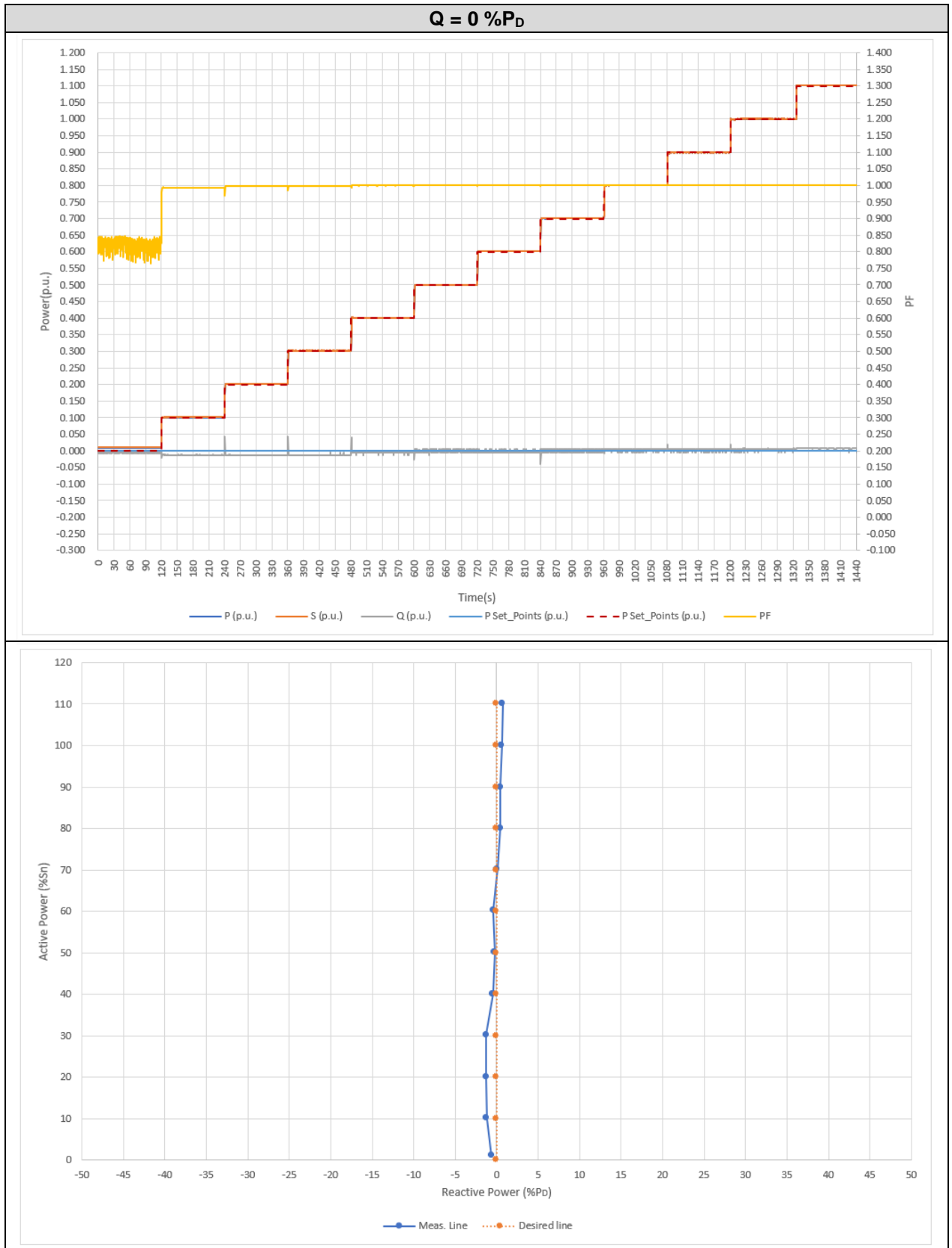

#### 4.4.1.2. Test 2: Rectangular Curve ( $Q = \pm 48.4 \%P_D$ )

This test verifies the capability of the inverter to provide a fixed value of reactive power. In addition, it is verified the Q control mode.

When the measurement is equal to or greater than 10%  $S_n$ , the allowable tolerance of reactive power measurement should be within  $\pm 2\% S_{max}$  or  $\pm 2.2\% P_D$ .

Test results are offered at tables below.

Rectangular Curve ( $Q=48.4 \%P_D$ / Capacitive)					
P Desired (% $S_n$ )	P measured (% $S_n$ )	Q desired (% $P_D$ )	Q measured (% $P_D$ )	Q Deviation ( $\pm 2.2\%P_D$ )	Power Factor ( $\cos \varphi$ )
0 <sup>(1)</sup>	0.6	--	-48.6	--	0.013
5 <sup>(1)</sup>	4.8	--	-48.7	--	0.098
10	9.9	-48.4	-48.7	-0.3	0.200
15	15.0	-48.4	-48.7	-0.3	0.296
20	19.9	-48.4	-48.7	-0.3	0.380
25	25.0	-48.4	-48.7	-0.3	0.458
30	30.0	-48.4	-48.7	-0.3	0.526
35	35.0	-48.4	-48.7	-0.3	0.586
40	40.0	-48.4	-48.7	-0.3	0.636
45	45.0	-48.4	-48.7	-0.3	0.680
50	50.1	-48.4	-48.7	-0.3	0.718
55	55.1	-48.4	-48.7	-0.3	0.751
60	60.1	-48.4	-48.8	-0.4	0.778
65	65.1	-48.4	-48.8	-0.4	0.802
70	70.0	-48.4	-48.8	-0.4	0.822
75	75.0	-48.4	-48.8	-0.4	0.840
80	80.0	-48.4	-48.7	-0.3	0.855
85	84.9	-48.4	-48.7	-0.3	0.868
90	89.9	-48.4	-48.7	-0.3	0.880
95	94.8	-48.4	-48.7	-0.3	0.891
100	99.3	-48.4	-48.7	-0.3	0.899
105	100.7	-48.4	-48.6	-0.2	0.901

(1) The reactive power accuracy is  $\pm 2\% S_{max}$ , which is not suitable for power below 10% $P_n$ .

Note: P is with respect to  $S_n$  , Q is according to measured  $P_D \approx 1.0 P_n$  (49.759 kW)

Rectangular Curve (Q=48.4 %P <sub>D</sub> / Inductive)					
P Desired (%S <sub>n</sub> )	P measured (%P <sub>D</sub> )	Q desired (%P <sub>D</sub> )	Q measured (%P <sub>D</sub> )	Q Deviation (±2.2%P <sub>D</sub> )	Power Factor (cos φ)
0 <sup>(1)</sup>	1.5	--	+48.7	--	0.031
5 <sup>(1)</sup>	5.0	--	+48.7	--	0.102
10	10.0	+48.4	+48.7	+0.3	0.202
15	15.0	+48.4	+48.7	+0.3	0.296
20	20.1	+48.4	+48.7	+0.3	0.382
25	25.1	+48.4	+48.7	+0.3	0.459
30	30.1	+48.4	+48.7	+0.3	0.527
35	35.1	+48.4	+48.7	+0.3	0.587
40	40.2	+48.4	+48.7	+0.3	0.639
45	45.1	+48.4	+48.7	+0.3	0.681
50	50.1	+48.4	+48.7	+0.3	0.719
55	55.1	+48.4	+48.7	+0.3	0.751
60	60.1	+48.4	+48.7	+0.3	0.778
65	65.0	+48.4	+48.7	+0.3	0.802
70	70.0	+48.4	+48.8	+0.4	0.822
75	75.1	+48.4	+48.8	+0.4	0.840
80	80.1	+48.4	+48.8	+0.4	0.855
85	85.0	+48.4	+48.8	+0.4	0.868
90	90.0	+48.4	+48.8	+0.4	0.880
95	95.1	+48.4	+48.8	+0.4	0.891
100	100.1	+48.4	+48.8	+0.4	0.900
105	101.5	+48.4	+48.7	+0.3	0.903

(<sup>1</sup>) The reactive power accuracy is ±2%S<sub>max</sub>, which is not suitable for power below 10%P<sub>n</sub>.

Note: P is with respect to S<sub>n</sub> , Q is according to measured PD ≈ 1.0 P<sub>n</sub> (49.759 kW)



Test results are represented at diagrams below.

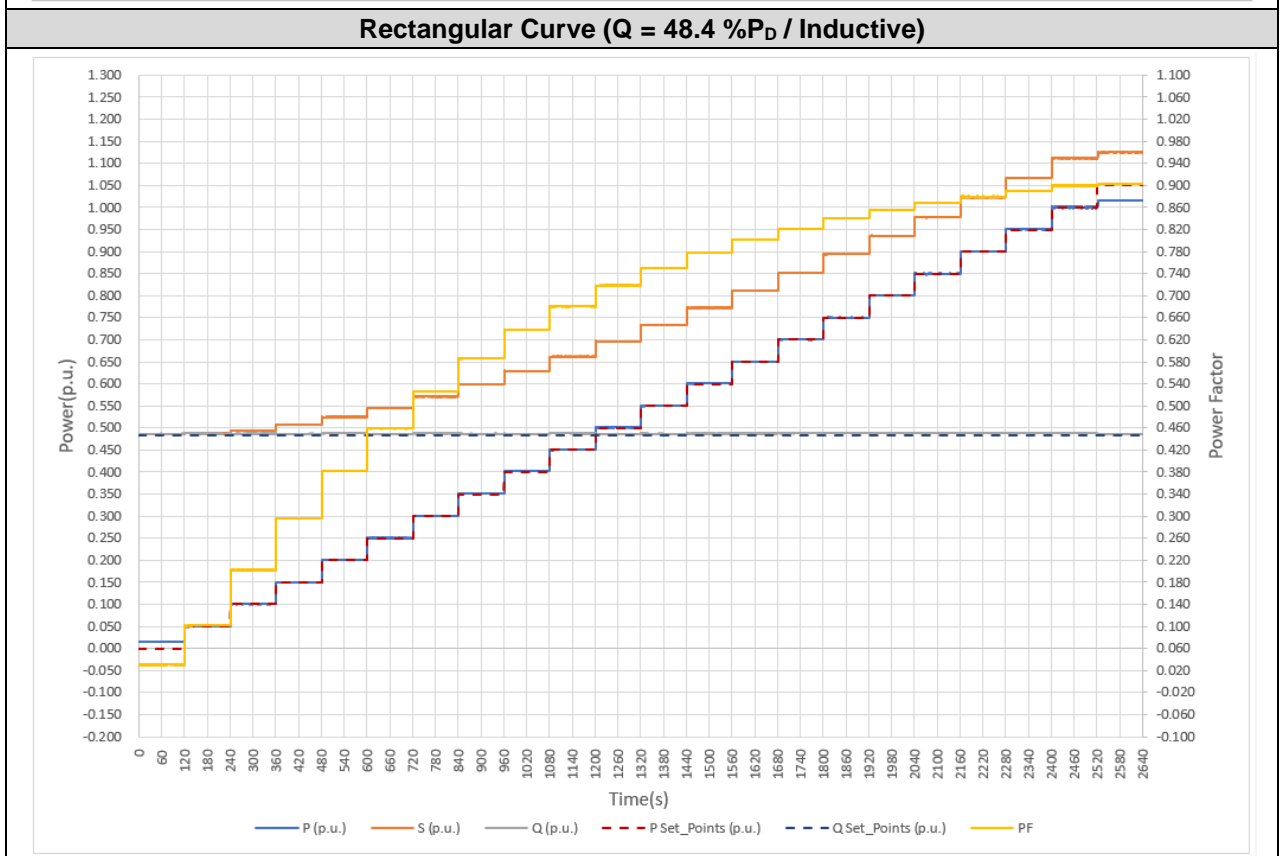
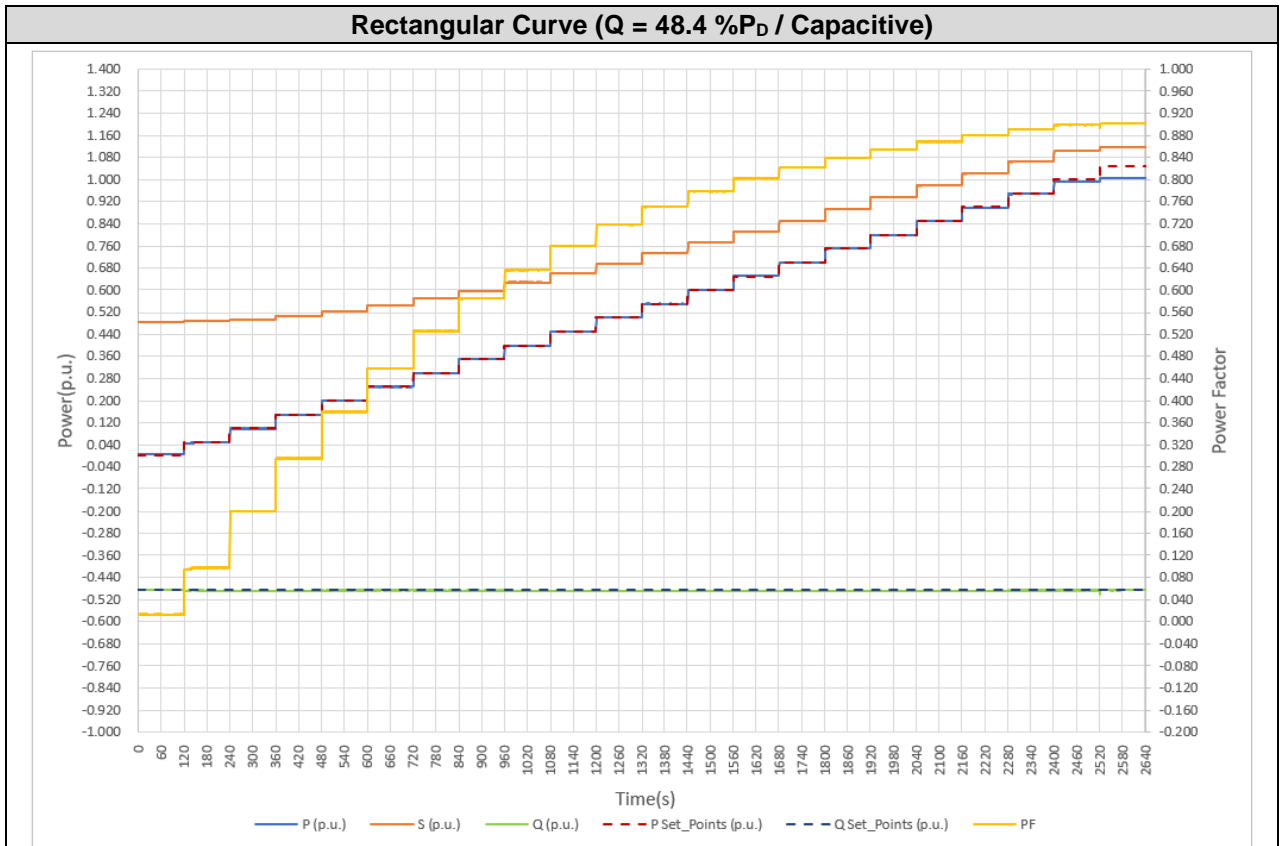

Rectangular Curve (Capacitive vs Inductive)

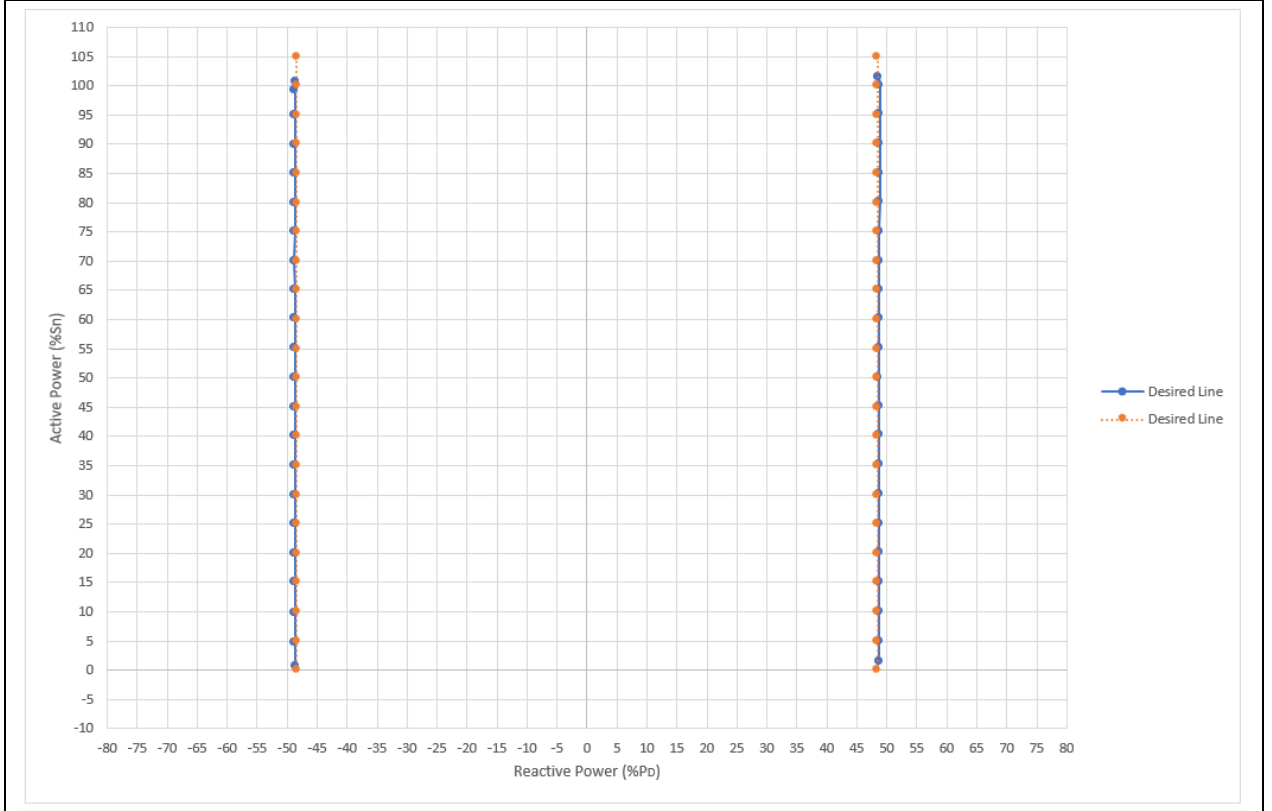

#### 4.4.1.3. Test 3: Triangular Curve (PF = ±0.8)

This test verifies the capability of the inverter to provide a fixed value of power factor. In addition, it is verified the PF control mode.

When the measurement is equal to or greater than 10%  $S_n$ , the allowable tolerance of reactive power measurement should be within  $\pm 2\% S_{max}$ .

Test results are offered at the tables below.

Triangular Curve (PF = 0.8 / Capacitive)						
P desired (% $S_n$ )	P measured (% $S_n$ )	Q measured (% $S_n$ )	Q desired (% $S_n$ )	Q deviation ( $\pm 2\% S_{max}$ ) <sup>(3)</sup>	Power factor measured (cos $\varphi$ )	Power factor deviation (cos $\varphi$ )
0 <sup>(1)</sup>	1.8	-1.4	0.0	--	0.797	-0.003
5 <sup>(1)</sup>	4.9	-3.7	-3.8	--	0.801	+0.001
10	10.0	-7.5	-7.5	0.0	0.800	0.000
15	15.1	-11.3	-11.3	0.0	0.801	+0.001
20	20.1	-15.1	-15.0	-0.1	0.800	0.000
25	25.0	-18.8	-18.8	0.0	0.800	0.000
30	30.0	-22.5	-22.5	0.0	0.800	0.000
35	35.0	-26.2	-26.3	+0.1	0.801	+0.001
40	40.0	-30.0	-30.0	0.0	0.800	0.000
45	45.0	-33.8	-33.8	0.0	0.800	0.000
50	49.9	-37.4	-37.5	+0.1	0.800	0.000
55	55.0	-41.2	-41.3	+0.1	0.800	0.000
60	60.0	-45.0	-45.0	0.0	0.800	0.000
65	65.0	-48.7	-48.8	+0.1	0.800	0.000
70	70.0	-52.4	-52.5	+0.1	0.800	0.000
75	75.0	-56.1	-56.3	+0.2	0.800	0.000
80	79.9	-59.9	-60.0	+0.1	0.800	0.000
85	85.0	-63.6	-63.8	+0.2	0.801	+0.001
90	89.7	-66.2	-67.5	+1.3	0.805	+0.005
95 <sup>(2)</sup>	89.7	-66.2	-71.3	--	0.805	+0.005
100 <sup>(2)</sup>	89.7	-66.2	-75.0	--	0.805	+0.005

<sup>(1)</sup> The reactive power accuracy is  $\pm 2\% S_n$ , which is not suitable for power below 10%  $P_n$ .

<sup>(2)</sup> Test performed in reactive power priority mode. Working in this mode, the inverter can't output the desired active power due to current limitation, so don't consider the deviation value.

<sup>(3)</sup> Q desired value is calculated from the desired power and fixed power factor (PF = 0.8).

Triangular Curve (PF = 0.8 / Inductive)						
P desired (%Sn)	P measured (%Sn)	Q measured (%Sn)	Q desired (%Sn)	Q deviation ( $\pm 2\%Sn$ )	Power factor measured (cos $\varphi$ )	Power factor deviation (cos $\varphi$ )
0 <sup>(1)</sup>	1.9	1.6	0.0	--	0.765	-0.035
5 <sup>(1)</sup>	5.1	3.8	3.8	--	0.801	+0.001
10	10.2	7.6	7.5	+0.1	0.800	0.000
15	15.1	11.2	11.3	-0.1	0.802	+0.002
20	20.2	15.0	15.0	0.0	0.802	+0.002
25	25.1	18.7	18.8	-0.1	0.802	+0.002
30	30.1	22.4	22.5	-0.1	0.802	+0.002
35	35.0	26.1	26.3	-0.2	0.802	+0.002
40	40.1	29.9	30.0	-0.1	0.801	+0.001
45	45.1	33.7	33.8	-0.1	0.800	0.000
50	50.1	37.6	37.5	+0.1	0.800	0.000
55	55.1	41.3	41.3	0.0	0.800	0.000
60	60.1	45.0	45.0	0.0	0.800	0.000
65	65.0	48.7	48.8	-0.1	0.800	0.000
70	70.1	52.5	52.5	0.0	0.800	0.000
75	75.1	56.3	56.3	0.0	0.800	0.000
80	80.0	60.0	60.0	0.0	0.800	0.000
85	85.0	63.7	63.8	-0.1	0.800	0.000
90	90.0	67.4	67.5	-0.1	0.800	0.000
95 <sup>(2)</sup>	90.0	67.4	71.3	--	0.800	0.000
100 <sup>(2)</sup>	90.0	67.4	75.0	--	0.800	0.000

<sup>(1)</sup> The reactive power accuracy is  $\pm 2\%Sn$ , which is not suitable for power below  $10\%Pn$ .

<sup>(2)</sup> Test performed in reactive power priority mode. Working in this mode, the inverter can't output the desired active power due to current limitation.

Note: Q desired value is calculated from the desired power and fixed power factor (PF = 0.8).

Test results are represented at the diagrams below.

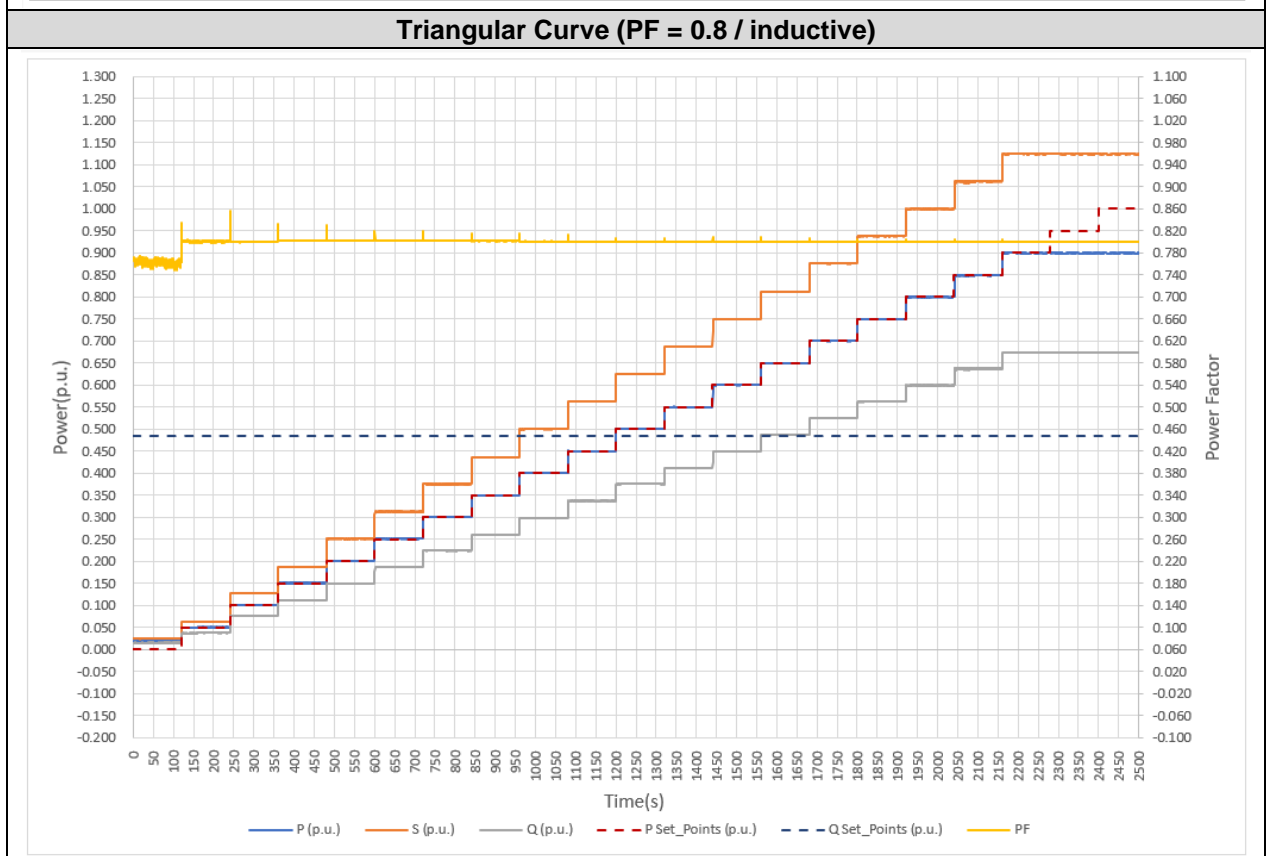
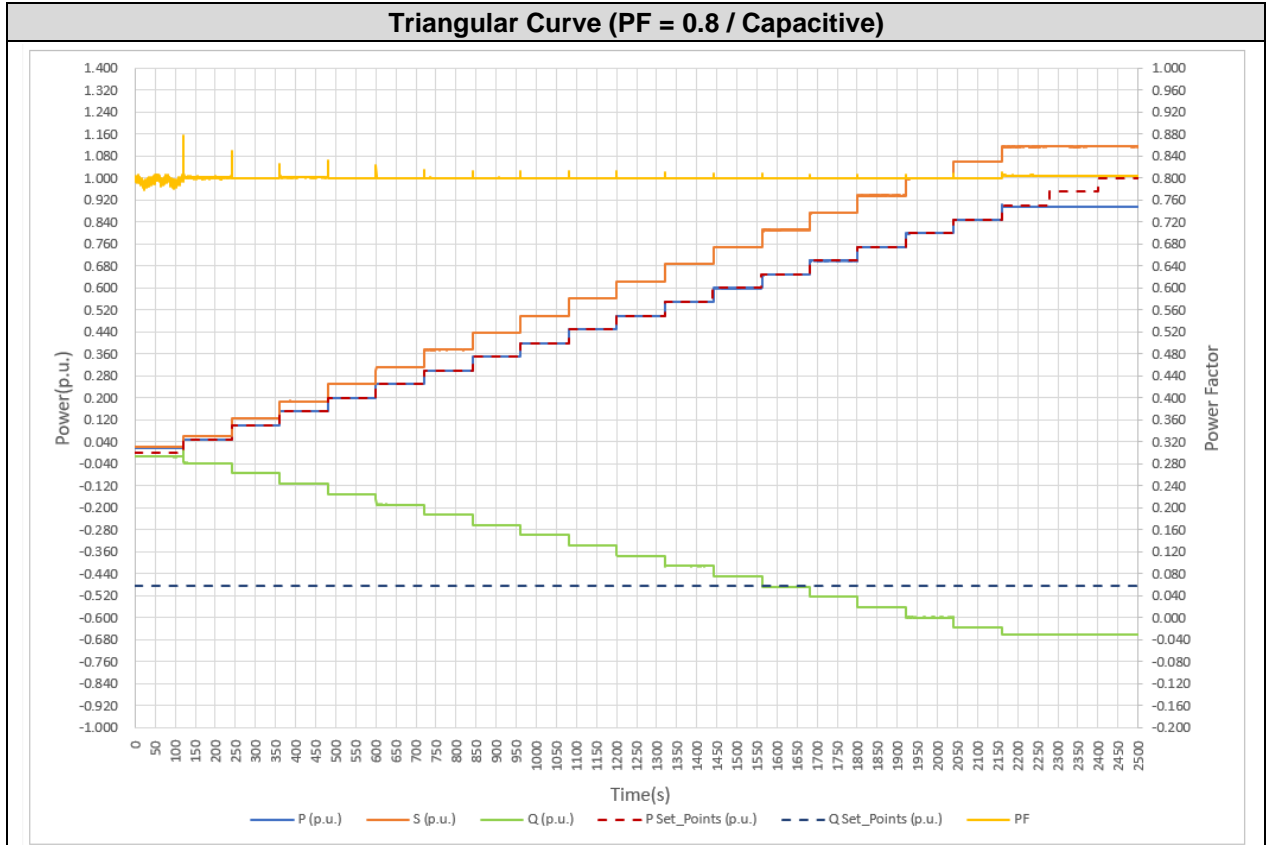

**Triangular Curve (Inductive vs Capacitive)**

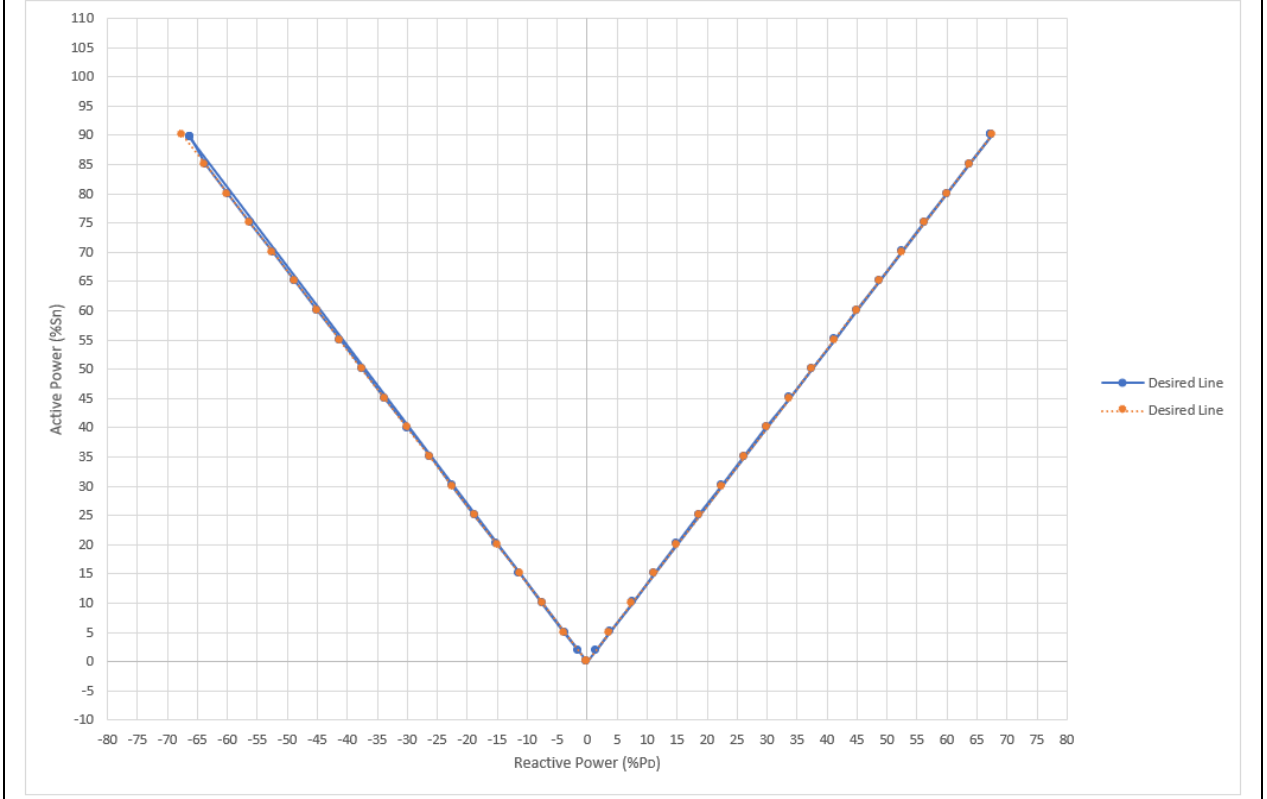

**4.4.1.4. Test 4: Reactive power capability at active power  $P_D$  in the voltage range (0.85Un~1.1Un)**

This test verifies the capability of the inverter to provide reactive power capability at active power  $P_D$  in the voltage range, as the Figure 13 of standard:

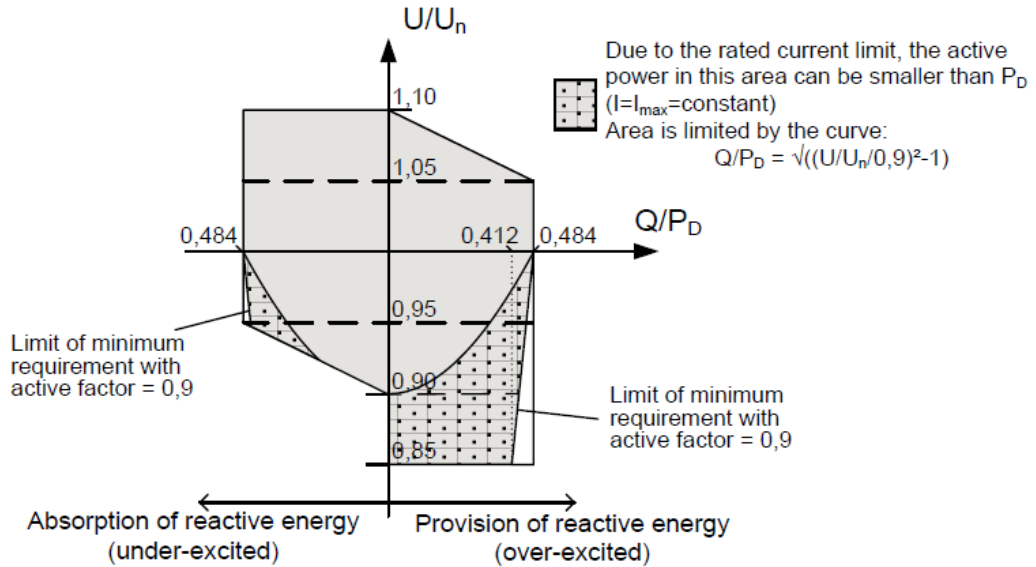

**Figure 13 — Reactive power capability at active power  $P_D$  in the voltage range (positive sequence component of the fundamental)**

Allowed tolerance for reactive power measurements is to be considered inside  $\pm 2\%$   $S_n$  or  $\pm 2.2\%$   $P_D$

Test results are offered at the tables below.

Reactive power capability at active power $P_D$ in the voltage range								
Step	Voltage desired (p.u.)	Voltage meas. (p.u.)	P desired (% $S_n$ )	P meas. (% $S_n$ )	Q meas. (% $P_D$ )	Q desired (% $P_D$ )	Q deviation ( $\pm 2.2\%P_D$ )	Power Factor measured (cos $\phi$ )
1	1.100	1.100	90.0	90.0	-48.6	-48.4	-0.2	0.881
2	1.100	1.101	90.0	90.1	-0.7	0.0	-0.7	1.000
3	1.050	1.051	90.0	90.0	48.6	+48.4	+0.2	0.881
4	1.000	1.001	90.0	89.8	48.7	+48.4	+0.3	0.880
5	0.900	0.901	90.0	89.6	43.8	+43.6	+0.2	0.899
6	0.850	0.851	90.0	89.2	41.3	+41.2	+0.1	0.908
7	0.850	0.850	90.0	89.5	-0.1	0.0	-0.1	1.000
8	0.900	0.901	90.0	89.8	0.0	0.0	0.0	1.000
9	0.950	0.951	90.0	89.6	-48.6	-48.4	-0.2	0.880
10	1.000	1.000	90.0	89.8	-48.7	-48.4	-0.3	0.880
11	1.050	1.050	90.0	89.8	-48.6	-48.4	-0.2	0.880
12	1.100	1.100	90.0	90.0	-48.6	-48.4	-0.2	0.881

Note: P is with respect to  $S_n$  , Q is according to measured  $P_D \approx 1.0 P_n$  (49.759kW), while voltage operating range is at 0.85Un ~ 1.1Un.

Reactive power capability at active power  $P_D$  in the voltage range (0.85Un~1.00Un)

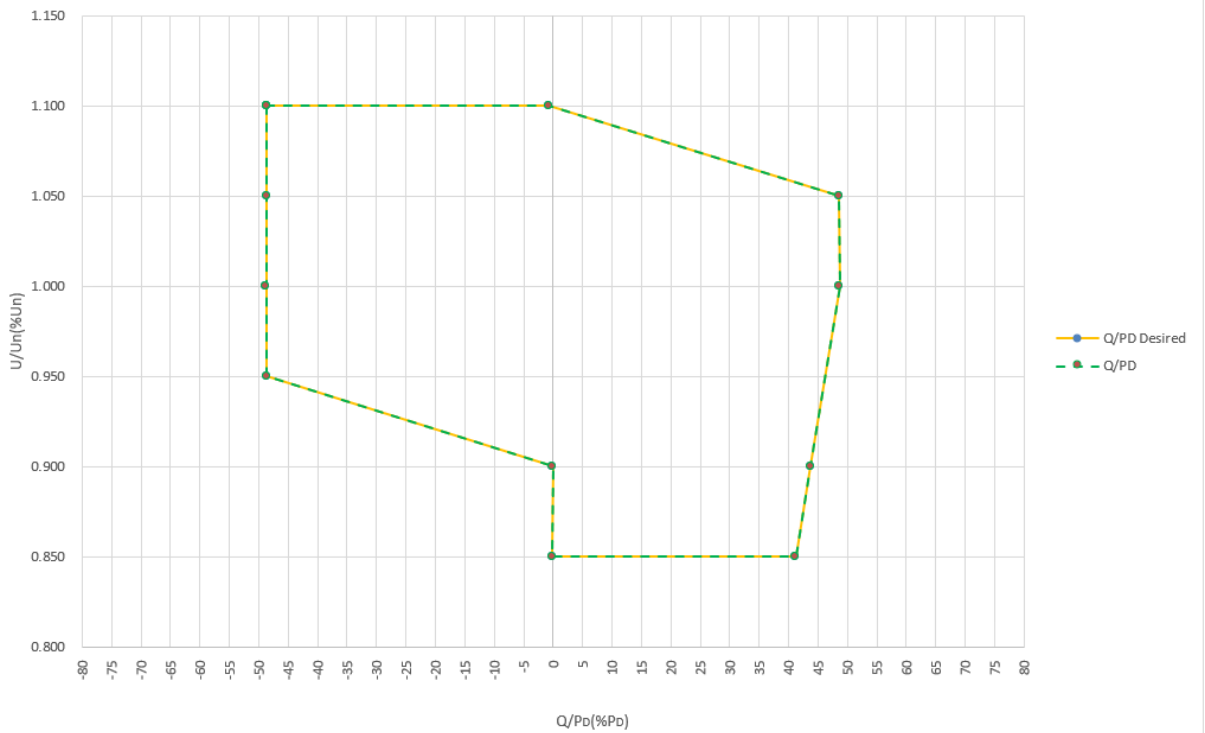
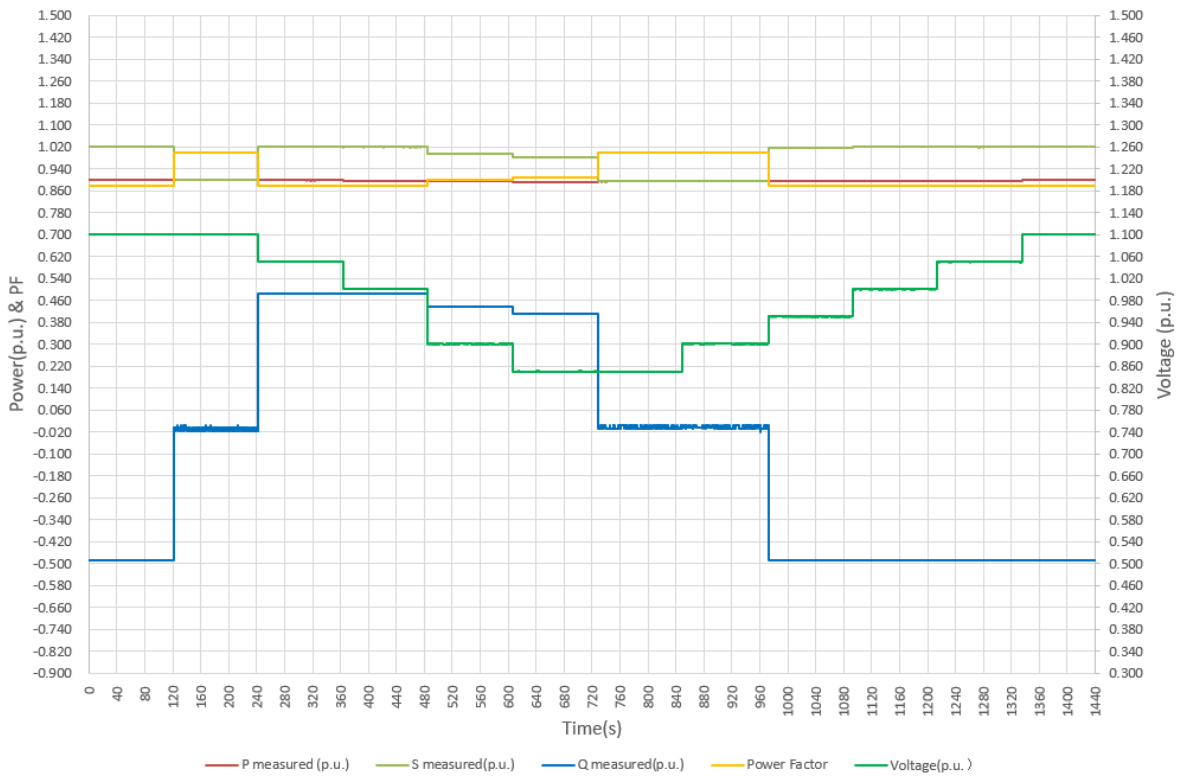



#### 4.4.2. Voltage related control mode

##### 4.4.2.1. Voltage related control mode Q(U)

The test has been done according to the clause 4.7.2.3.3 of the standard.

Note: The activation and deactivation of the function and its settings can be field adjustable through AISWEI website interface, under the menu of Reactive Power Limit, choose mode: Variable Q; Reactive Power Limit not-checked indicating function deactivation, while Reactive Power Limit checked indicating function activation; means to setting the parameter are protected by key , when log in the interface.

Setting the characteristic as following to prove configurability of the inverter:

- $U_1 = 0.93$ ,  $Q_{max}=48.4\%P_n=48.4\%P_D$
- $U_2 = 0.96$ ,  $Q = 10.0\%P_n=10.0\% P_D$
- $U_3 = 1.04$ ,  $Q = -10.0\%P_n=-10.0\% P_D$
- $U_4 = 1.07$ ,  $-Q_{max}=-48.4\%P_n=-48.4\%P_D$

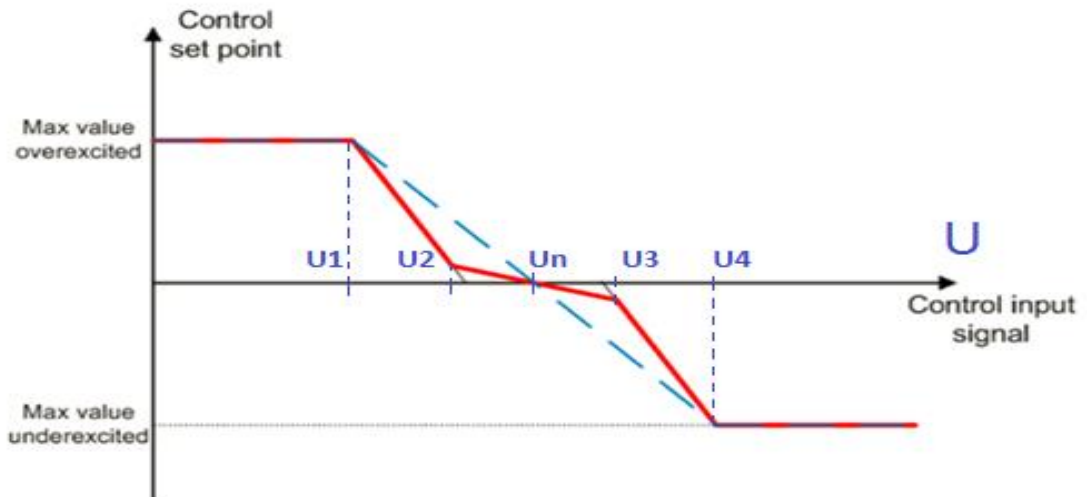

Figure 16 — Example characteristics for Q respectively  $\cos \varphi$  control mode

Test results are offered at the tables below.

Undervoltage Test 1						
P/Pn setpoint (%)	U setpoint	P measured (%Sn)	V measured (p.u.)	Q measured (%P <sub>D</sub> )	Q desired (%P <sub>D</sub> )	ΔQ (p.u.) (±2.2%P <sub>D</sub> )
50	1.000 Un	50.1	1.001	+0.4	0.0	+0.4
50	0.990 Un	50.1	0.990	+2.5	+2.5	-0.0
50	0.980 Un	50.1	0.980	+5.1	+5.0	+0.1
50	0.970 Un	50.1	0.970	+7.6	+7.5	+0.1
50	0.960 Un	50.1	0.960	+10.1	+10.0	+0.1
50	0.950 Un	50.1	0.950	+22.9	+22.8	+0.1
50	0.940 Un	50.0	0.940	+35.8	+35.6	+0.2
50	0.930 Un	49.8	0.930	+48.7	+48.4	+0.3
50	0.920 Un	49.8	0.920	+48.7	+48.4	+0.3
50	0.910 Un	49.8	0.910	+48.8	+48.4	+0.4
50	0.900 Un	49.7	0.900	+48.8	+48.4	+0.4
50	0.950 Un	50.1	0.950	+22.9	+22.8	+0.1
50	1.000 Un	50.1	1.001	+0.4	0.0	+0.4

Overvoltage Test 2						
P/Pn setpoint (%)	U setpoint	P measured (%Sn)	V measured (p.u.)	Q measured (%P <sub>D</sub> )	Q desired (%P <sub>D</sub> )	ΔQ (p.u.) (±2.2%P <sub>D</sub> )
50	1.000 Un	50.1	1.001	-0.2	0.0	-0.2
50	1.010 Un	50.1	1.010	-2.5	-2.5	0.0
50	1.020 Un	50.1	1.020	-5.1	-5.0	-0.1
50	1.030 Un	50.1	1.030	-7.5	-7.5	0.0
50	1.040 Un	50.1	1.041	-10.1	-10.0	-0.1
50	1.050 Un	49.9	1.051	-22.9	-22.8	-0.1
50	1.060 Un	49.7	1.061	-35.8	-35.6	-0.2
50	1.070 Un	49.3	1.070	-48.7	-48.4	-0.3
50	1.080 Un	49.2	1.081	-48.7	-48.4	-0.3
50	1.090 Un	49.2	1.090	-48.7	-48.4	-0.3
50	1.100 Un	49.2	1.100	-48.7	-48.4	-0.3
50	1.050 Un	49.9	1.050	-22.9	-22.8	-0.1
50	1.000 Un	50.2	1.001	-0.1	0.0	-0.1

Note: P is with respect to Sn , Q is according to measured P<sub>D</sub> ≈ 1.0 Pn (49.759kW)

Voltage related control mode - Q(U) of Undervoltage Test 1

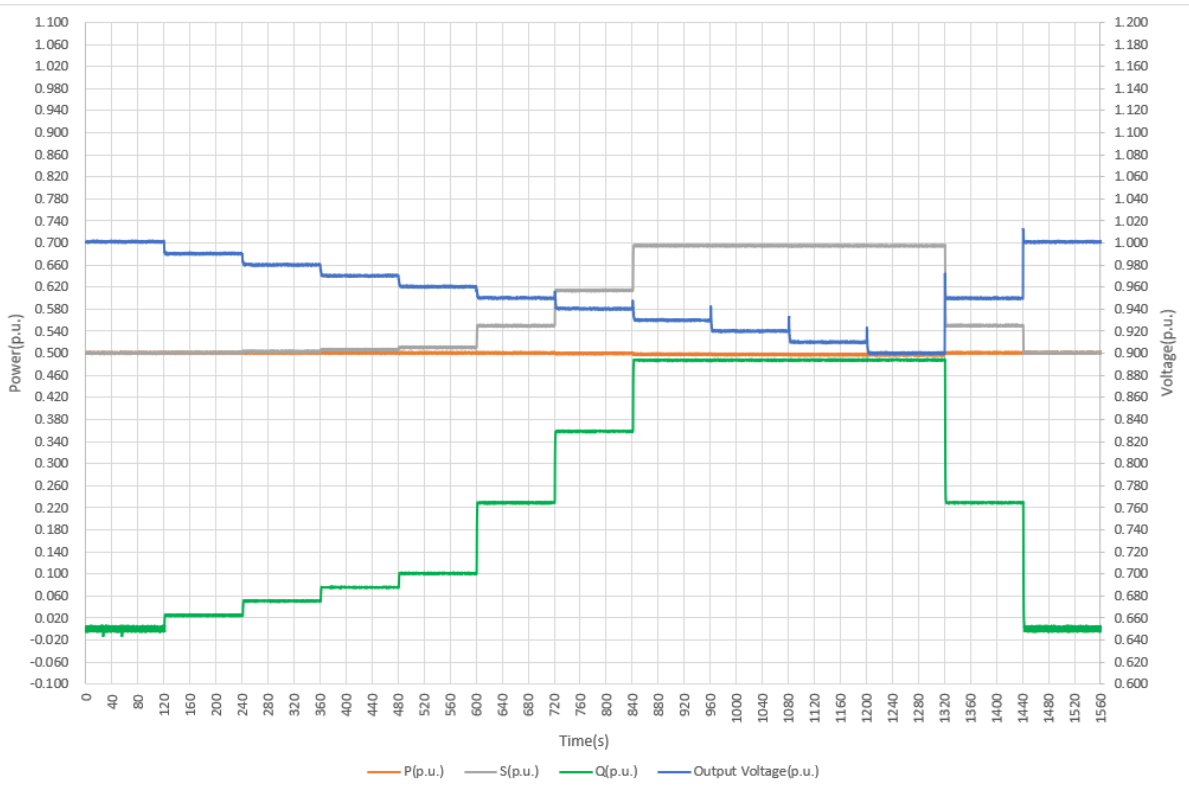

Voltage related control mode - Q(U) of Overvoltage Test 2

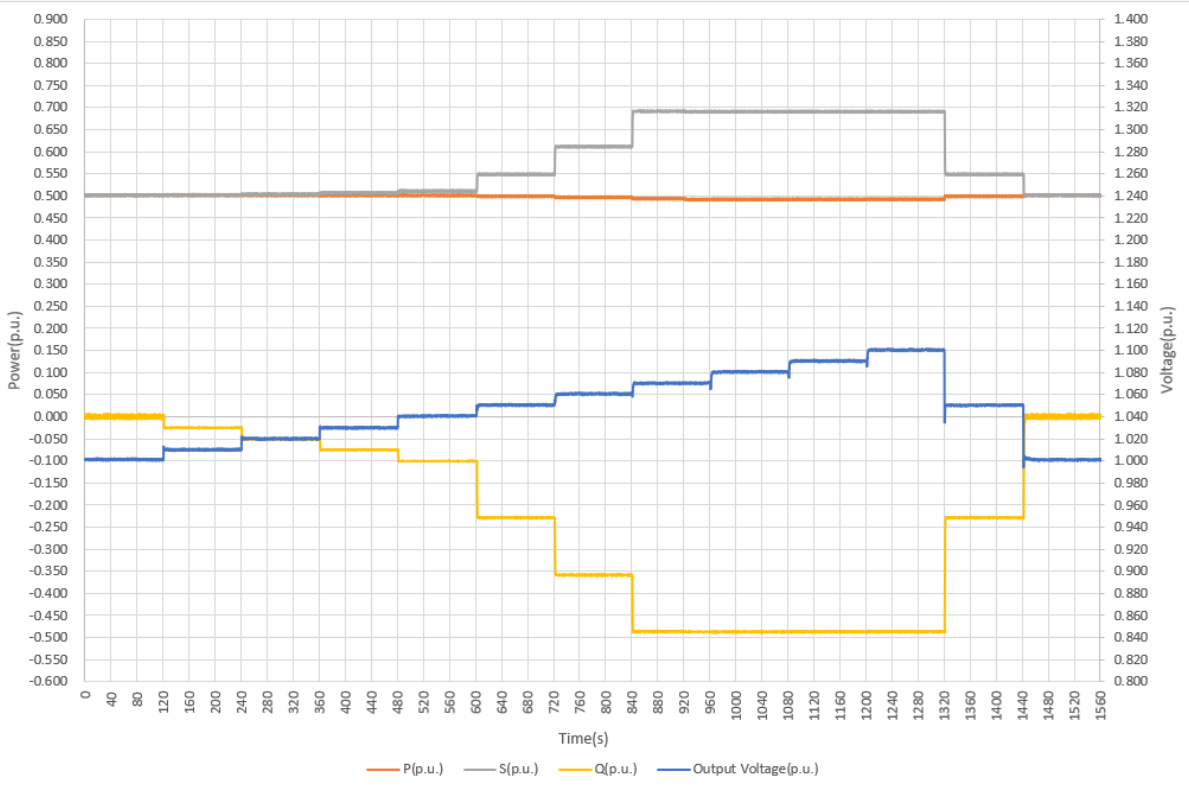

Voltage vs Reactive Power

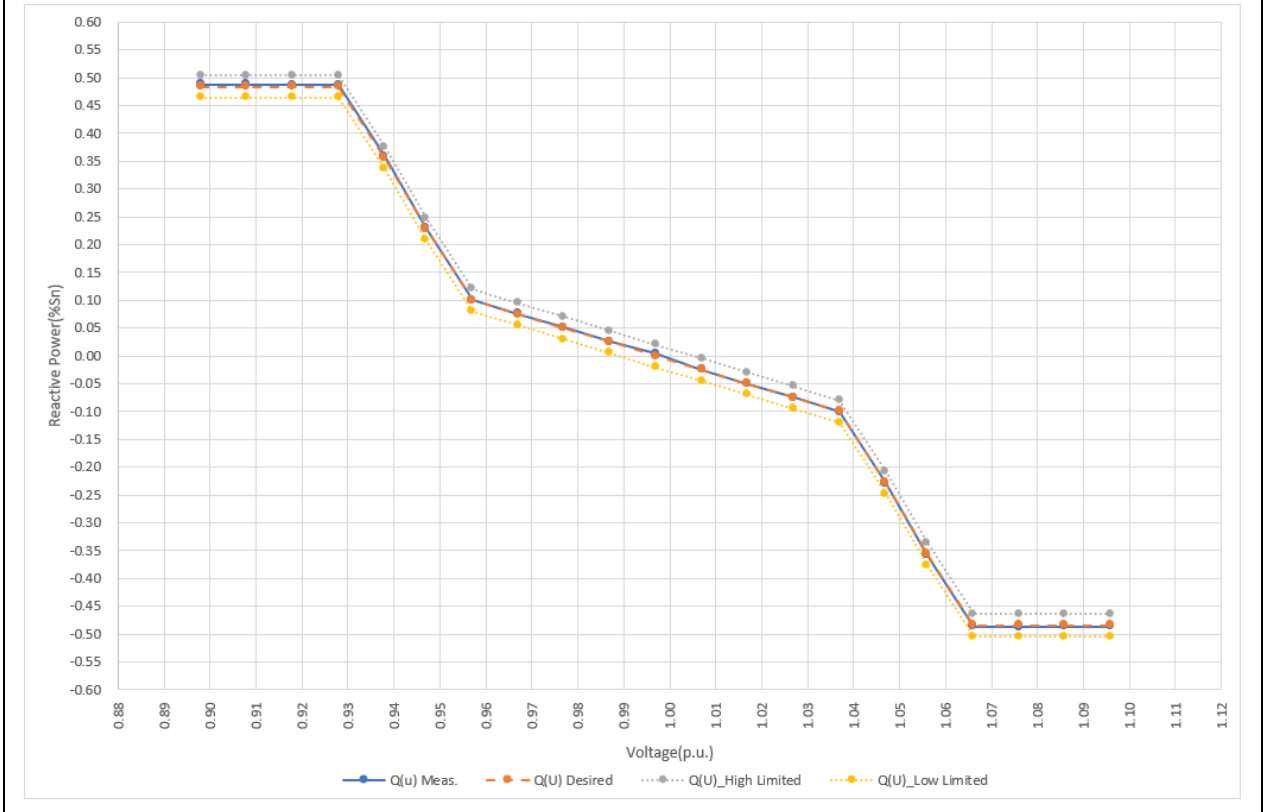

#### 4.4.2.2 Voltage related control mode Q(U) with lock-in/lock-out function

The test has been done according to the clause 4.7.2.3.3 of the standard.

Two active power levels shall be configurable both at least in the range of 0 % to 100 % of  $P_D$ . The lock-in value turns the Q(U) mode on, the lock-out value turns Q(U) off. If lock-in is larger than lock-out a hysteresis is given. See also Figure 14 in the standard.

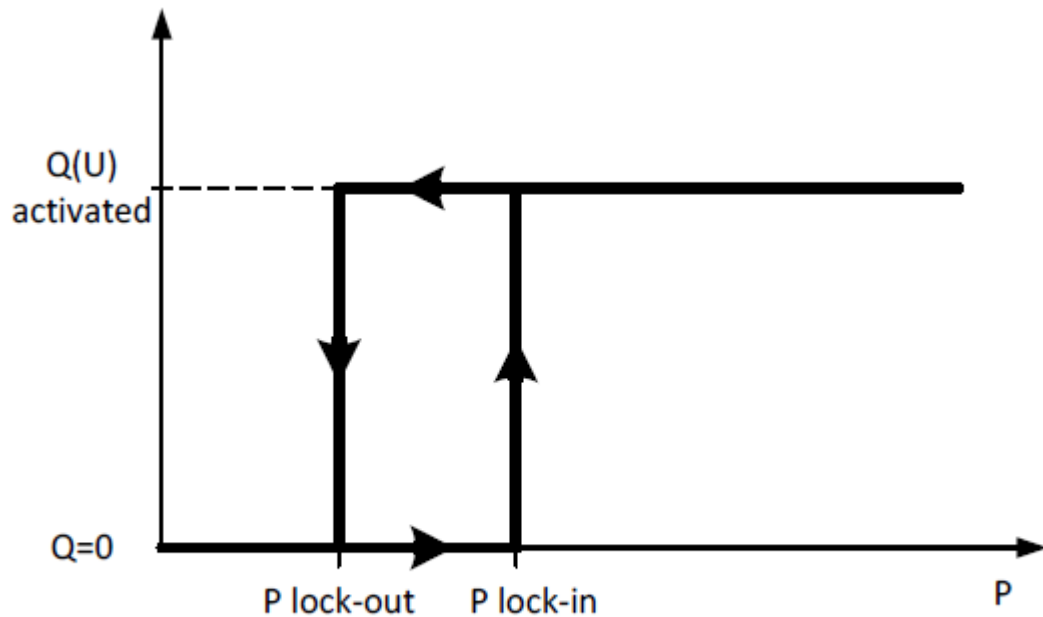

Figure 14 – Example of lock-in and lock-out values for Q(U) mode

Setting the characteristic as following to prove configurability of the inverter:

- $U1 = 0.93$ ,  $Q_{max} = 48.4\%P_n = 48.4\%P_D$
  - $U2 = 0.96$ ,  $Q = 10.0\%P_n = 10.0\%P_D$
  - $U3 = 1.04$ ,  $Q = -10.0\%P_n = -10.0\%P_D$
  - $U4 = 1.07$ ,  $-Q_{max} = -48.4\%P_n = -48.4\%P_D$
- $P_{lock-in} = 30\%P_n = 30\%P_D$ ,  $P_{lock-out} = 20\%P_n = 20\%P_D$

Test results are offered at the tables below.

Reactive power injection in relation with the Voltage (Inductive)						
P/Pn setpoint (%Pn)	U setpoint (p.u.)	P measured (%Sn)	V measured (p.u.)	Q measured (%P <sub>D</sub> )	Q desired (%P <sub>D</sub> )	ΔQ (p.u.) (±2.2%P <sub>D</sub> )
<20.0	0.920	15.1	0.919	+1.3	0.0	+1.3
25.0	0.920	25.1	0.919	+1.3	0.0	+1.3
35.0	0.920	35.1	0.920	+48.5	+48.4	+0.1
50.0	0.920	50.0	0.920	+48.7	+48.4	+0.3
75.0	0.920	75.1	0.920	+48.8	+48.4	+0.4
90.0	0.920	90.0	0.921	+48.8	+48.4	+0.4
100.0	0.920	99.5	0.921	+48.8	+48.4	+0.4
50.0	0.920	50.0	0.920	+48.6	+48.4	+0.2
25.0	0.920	24.9	0.919	+48.5	+48.4	+0.1
<20.0	0.920	15.0	0.919	+1.3	0.0	+1.3
35.0	0.920	35.0	0.920	+48.6	+48.4	+0.2
35.0	0.950	35.2	0.950	+23.8	+24.2	-0.4
35.0	1.000	35.2	1.001	+1.3	0.0	+1.3

Note: P is with respect to S<sub>n</sub> , Q is according to measured P<sub>D</sub> ≈ 1.0 P<sub>n</sub> (49.759kW)

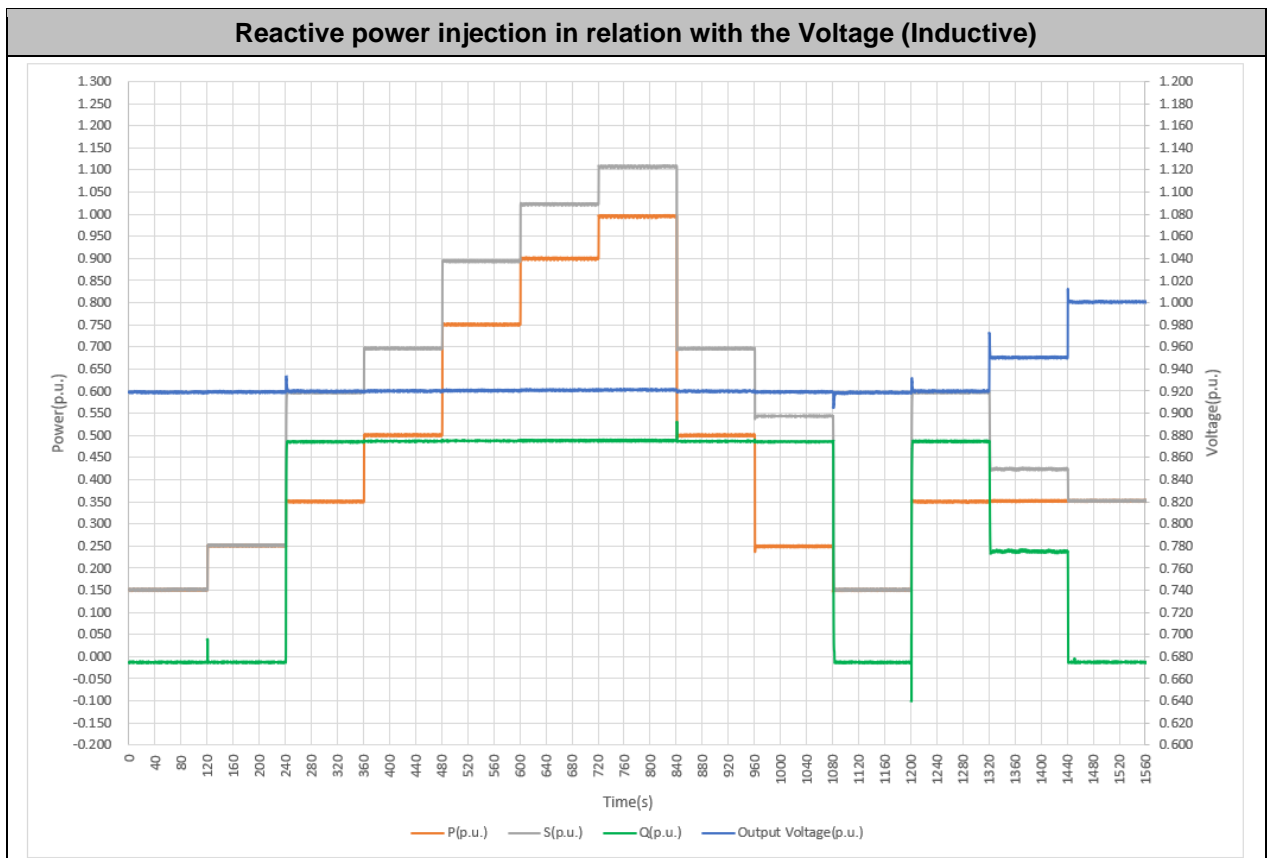

Reactive power injection in relation with the Voltage (Capacitive)						
P/Pn setpoint (%Pn)	U setpoint (p.u.)	P measured (%Sn)	V measured (p.u.)	Q measured (%P <sub>D</sub> )	Q desired (%P <sub>D</sub> )	ΔQ (p.u.) (±2.2%P <sub>D</sub> )
<20.0	1.080	15.0	1.080	-1.3	0.0	-1.3
25.0	1.080	25.1	1.080	-1.3	0.0	-1.3
35.0	1.080	35.0	1.080	-48.7	-48.4	-0.3
50.0	1.080	50.0	1.080	-48.8	-48.4	-0.4
75.0	1.080	75.0	1.081	-48.8	-48.4	-0.4
90.0	1.080	89.9	1.081	-48.7	-48.4	-0.3
100.0	1.080	99.2	1.081	-48.7	-48.4	-0.3
50.0	1.080	50.0	1.080	-48.8	-48.4	-0.4
25.0	1.080	25.0	1.080	-48.7	-48.4	-0.3
<20.0	1.080	14.9	1.080	-1.3	0.0	-1.3
35.0	1.080	35.0	1.080	-48.7	-48.4	-0.3
35.0	1.050	34.9	1.051	-24.1	-24.2	+0.1
35.0	1.000	35.1	1.001	-0.8	0.0	-0.8

Note: P is with respect to S<sub>n</sub> , Q is according to measured P<sub>D</sub> ≈ 1.0 P<sub>n</sub> (49.759kW)

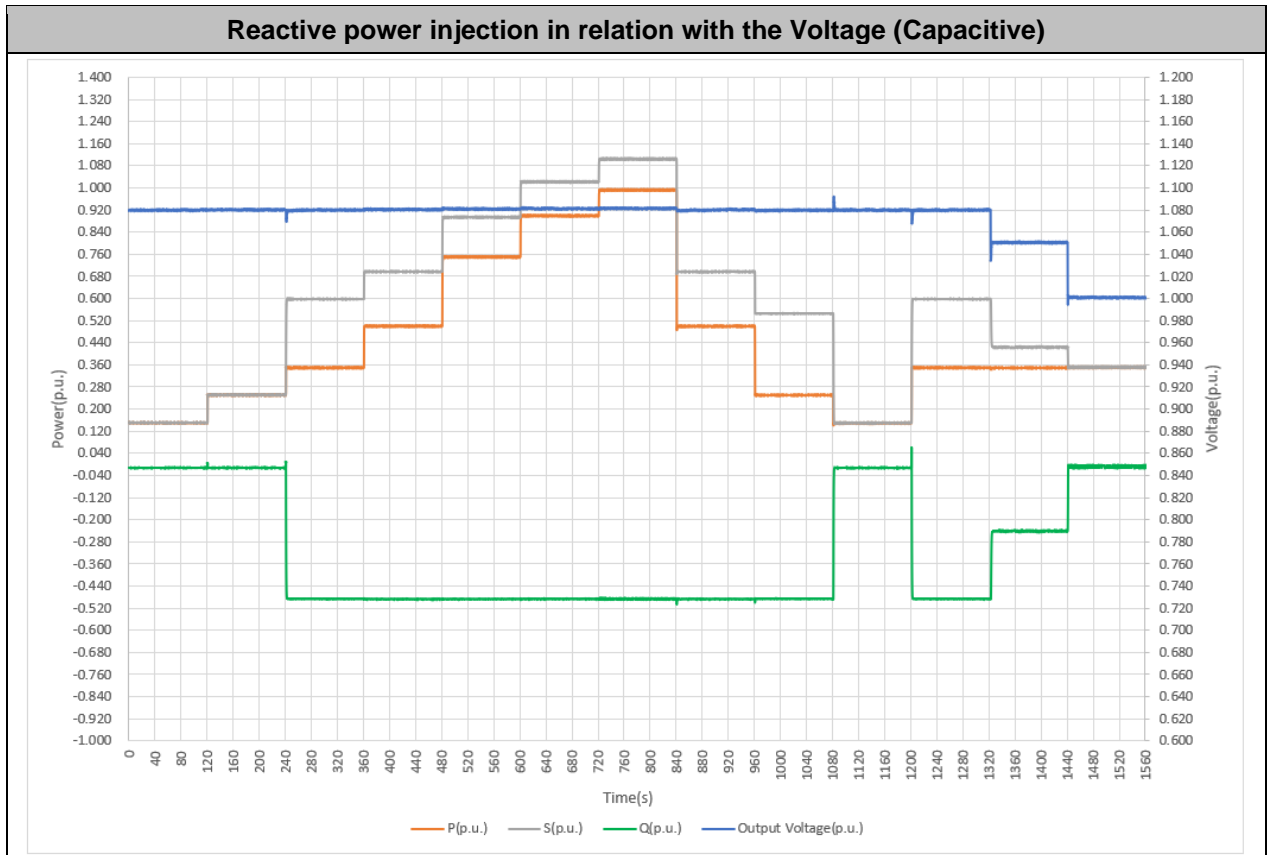

**4.4.2.3 Static accuracy**

The test has been done according to the clause 4.7.2.3.3 of the standard.

The dynamics of the control shall correspond with a first order filter having a time constant that is configurable in the range of 3 s to 60 s.

The dynamic accuracy shall be in accordance with Figure 15 in the standard with a maximum tolerance of  $\pm 5\%P_D$  plus a time delay of up to 3 seconds deviating from an ideal first order filter response.

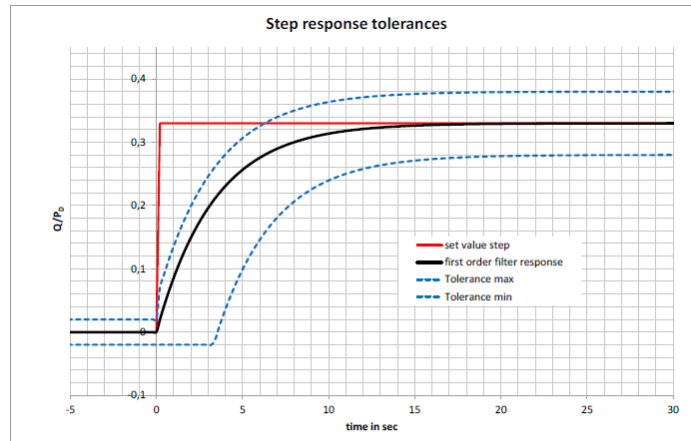

Figure 15 — Example of dynamic control response and tolerance band for a step from Q=0 to Q= 33%P<sub>D</sub> with τ=3,33s

Test results are offered at the tables below.

Settling time = 3 s				
%P <sub>n</sub>	Steps	Time measured (s)	Q Measured (%P <sub>D</sub> )	Δ Q (%Sn) < ±2.2%P <sub>D</sub>
50	Q = 0 → Q = 33 %Sn (33%P <sub>D</sub> )(Inductive)	t = 1.2	+33.3	+0.3
	Q = 33 %Sn(33%P <sub>D</sub> )(Inductive) → Q = 33 %Sn(33%P <sub>D</sub> ) (Capacitive)	t = 1.6	-33.3	-0.3
	Q = 33 %Sn(33%P <sub>D</sub> )(Capacitive) → Q = 0	t = 1.4	-0.1	-0.1

Settling time = 60 s				
%P <sub>n</sub>	Steps	Time measured (s)	Q Measured (%P <sub>D</sub> )	Δ Q (%Sn) < ±2.2%P <sub>D</sub>
50	Q = 0 → Q = 33 %Sn (33%P <sub>D</sub> )(Inductive)	t = 21.6	+35.9	-0.8
	Q = 33 %Sn(33%P <sub>D</sub> )(Inductive) → Q = 33 %Sn(33%P <sub>D</sub> ) (Capacitive)	t = 30.2	-36.2	+0.5
	Q = 33 %Sn(33%P <sub>D</sub> )(Capacitive) → Q = 0	t = 22.8	+1.9	+1.9

Note: P is with respect to S<sub>n</sub> , Q is according to measured P<sub>D</sub> ≈ 1.0 P<sub>n</sub> (49.759kW)



**Reactive power injection dynamic control response and tolerance band (Settling time = 3 s)**

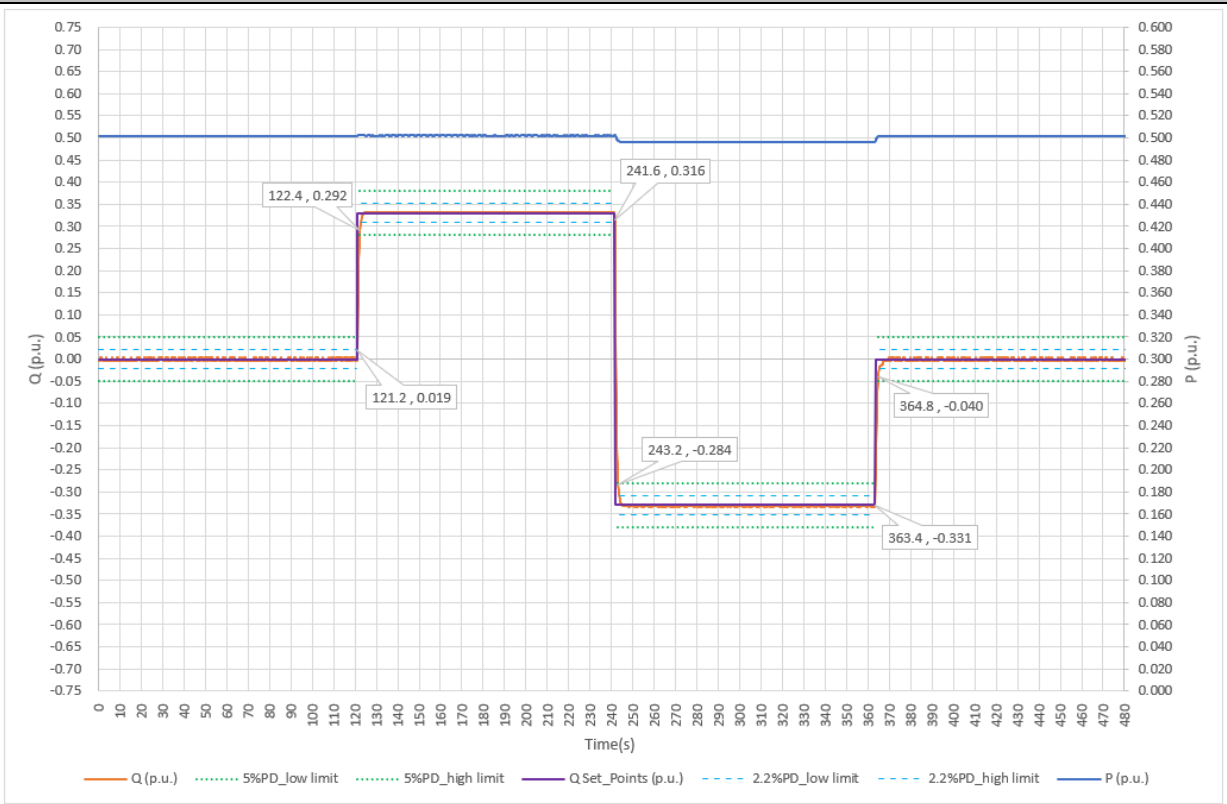

**Reactive power injection dynamic control response and tolerance band (Settling time = 60 s)**



**4.4.2.4 Power related control mode**

The test has been done according to the clause 4.7.2.3.4 of the standard.

The power related control mode  $\cos \phi$  (P) controls the  $\cos \phi$  of the output as a function of the active power output.

For power related control modes, a characteristic defined by the manufacturer as follows:

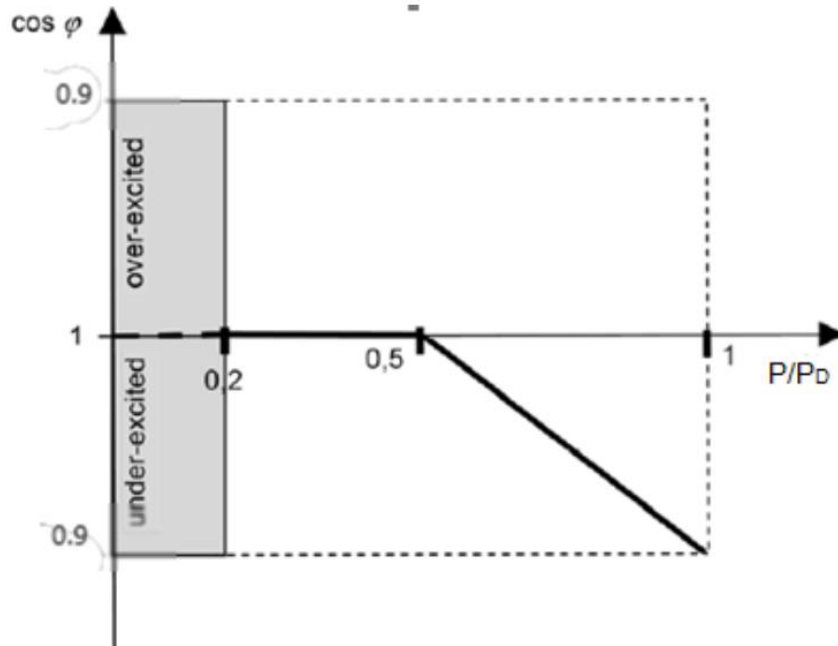

Resulting from a change in active power output a new  $\cos \phi$  set point is defined according to the set characteristic. The response to a new  $\cos \phi$  set value shall be as fast as technically feasible to allow the change in reactive power to be in synchrony with the change in active power. The new reactive power set value shall be reached at the latest within 10 s after the end value of the active power is reached. The static accuracy of each  $\cos \phi$  set point shall be according to 4.7.2.2.

The results are offered in the table below (Note: 10 %P<sub>n</sub> has not measured in the following test):

Setting $\cos \phi$ (P) with the standard characteristic curve (20 %P <sub>D</sub> to 100 %P <sub>D</sub> )							
Active Power setting (%P <sub>D</sub> )	Active Power measured (p.u.)	Reactive Power measured (p.u.)	$\cos \phi$ measured	Desired $\cos \phi$	Desired Q (p.u.)	$\Delta Q$ (p.u.) ( $\pm 2.2\%P_D$ )	Transient period (<10s)
20	0.202	-0.010	0.999	1.000	0.000	-0.010	
30	0.303	-0.010	0.999	1.000	0.000	-0.010	--
40	0.405	-0.004	1.000	1.000	0.000	-0.004	--
50	0.506	-0.004	1.000	1.000	0.000	-0.004	--
60	0.607	-0.127	0.979	0.980	-0.122	-0.005	1.00
70	0.707	-0.210	0.958	0.960	-0.204	-0.006	0.80
80	0.806	-0.297	0.938	0.940	-0.290	-0.007	0.80
90	0.904	-0.391	0.918	0.920	-0.383	-0.008	0.80
100	1.002	-0.489	0.898	0.900	-0.484	-0.005	0.60

Note: 1. The desired Q is calculated from  $Q = -\sqrt{(S^2 - P^2)}$ .  
 2. P is with respect to S<sub>n</sub>, Q is according to measured P<sub>D</sub>  $\approx$  1.0 P<sub>n</sub> (49.759kW)

Setting  $\cos \phi(P)$  with standard characteristic curve (20 % $P_D$  to 100 % $P_D$ )

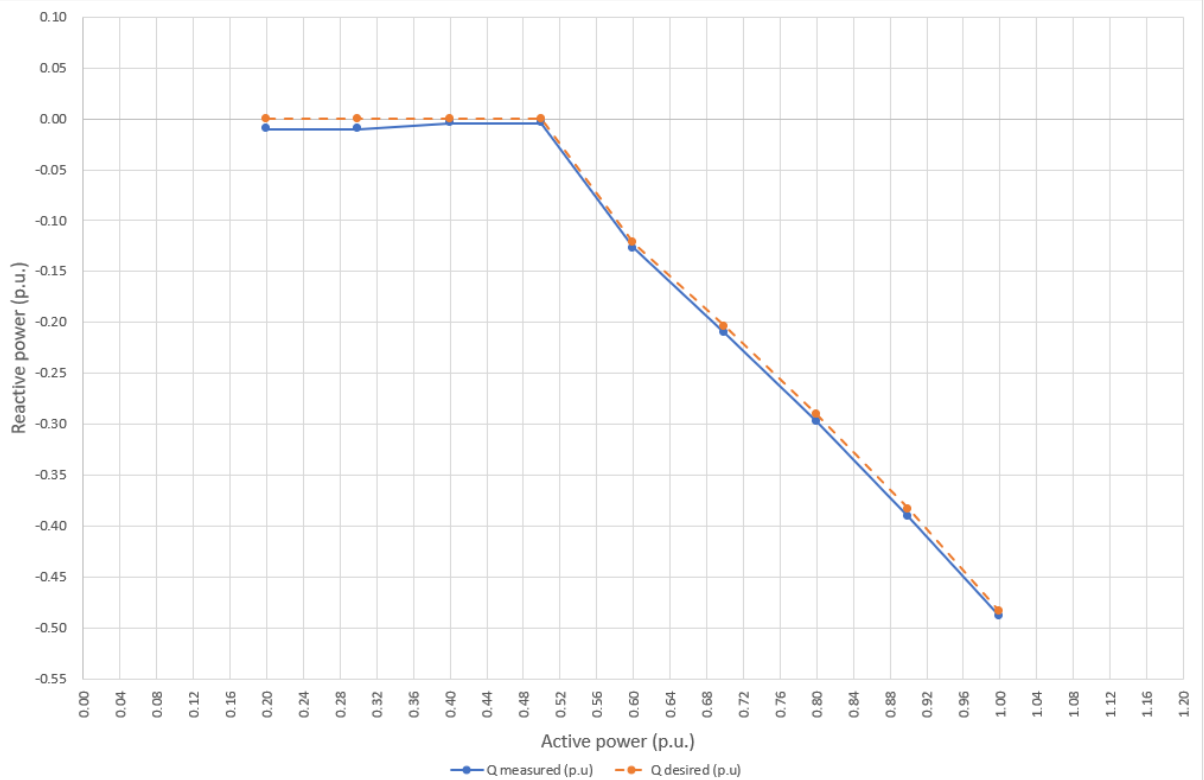
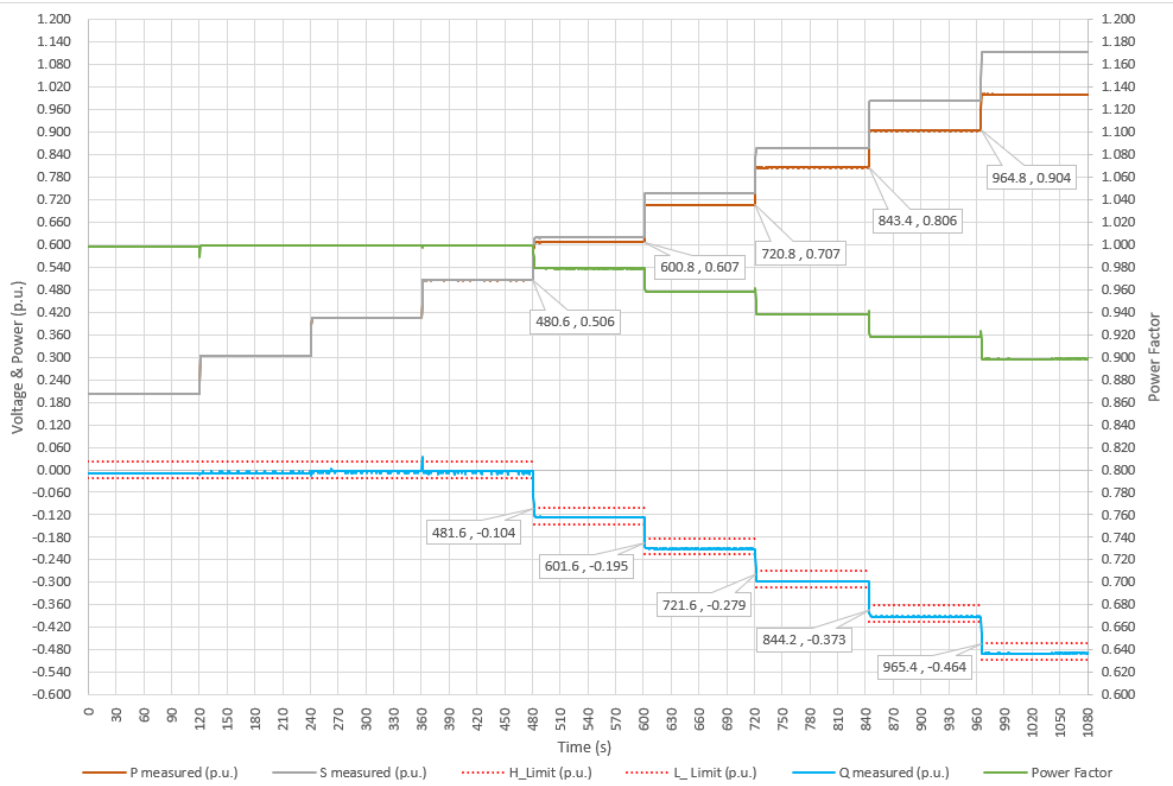

**4.4.3. Voltage related active power reduction (Volt-Watt)**

The test has been done according to the clause 4.7.3 of the standard.

The final implemented logic can be chosen by the manufacturer. Nevertheless, this logic shall not cause steps or oscillations in the output power. The power reduction caused by such a function may not be faster than an equivalent of a time constant  $\tau = 3 \text{ s}$  ( $= 33 \text{ %/s}$  at a 100 % change).

The following parameters have been set by the manufacturer for this test:

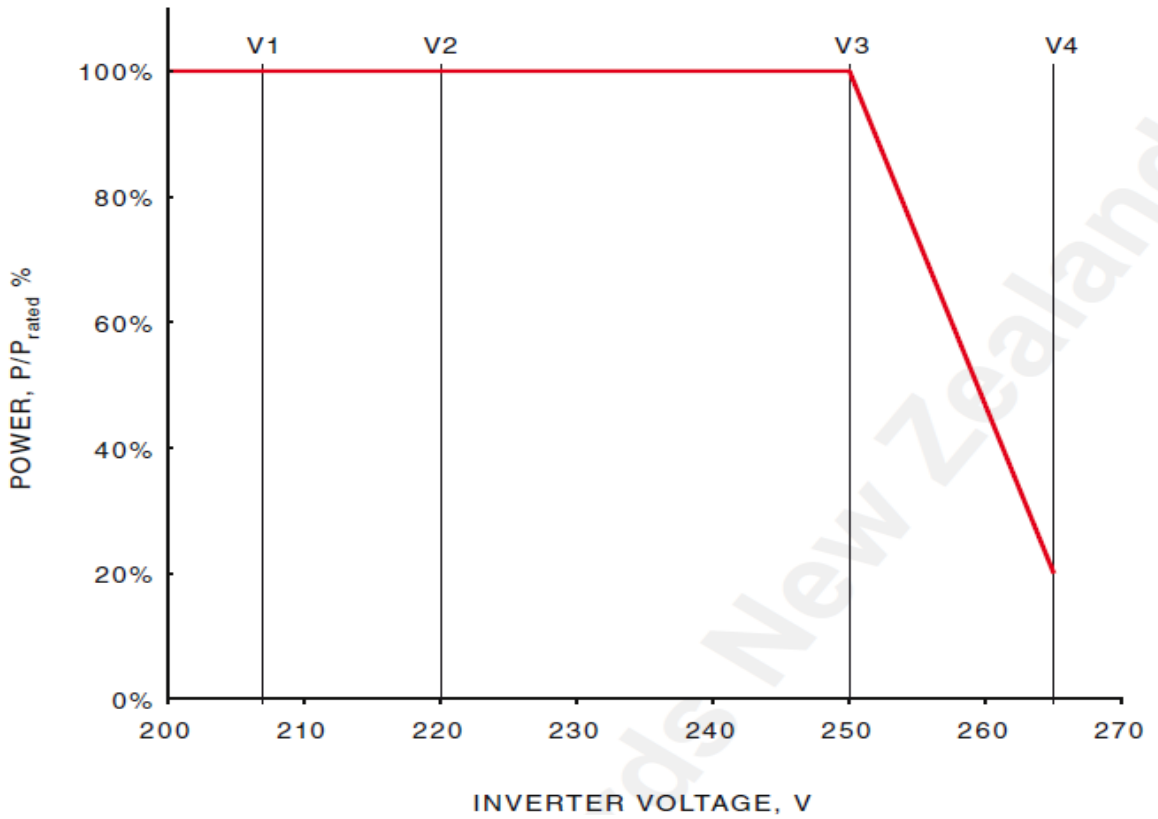

Test 1 and Test 2 setpoint as following:

Reference	Test 1 Set points		Test 2 Set points	
	Volt. (%Un)	Power (%Pn)	Volt. (%Un)	Power (%Pn)
V1	90.0%	100%	90.0%	100%
V2	95.6%	100%	95.6%	100%
V3	104.0%	100%	108.7%	100%
V4	110.0%	20%	115.2%	20%

Test results are offered at tables below.

<b>Volt-Watt TEST 1</b>					
<b>V setting (p.u.)</b>	<b>V meas. (p.u.)</b>	<b>P desired (p.u.)</b>	<b>P meas. (p.u.)</b>	<b>P deviation (p.u.)</b>	<b>Response time (s)</b>
0.900	0.900	1.000	0.995	-0.005	--
0.950	0.950	1.000	0.998	-0.002	--
1.000	1.001	1.000	1.001	+0.001	--
1.020	1.020	1.000	1.001	+0.001	--
1.040	1.040	1.000	1.002	+0.002	--
1.050	1.051	0.867	0.859	-0.008	2.0
1.060	1.060	0.771	0.772	+0.001	1.0
1.070	1.070	0.657	0.654	-0.003	1.4
1.100	1.100	0.200	0.186	-0.014	2.0
<b>Volt-Watt TEST 2</b>					
<b>V setting (p.u.)</b>	<b>V meas. (p.u.)</b>	<b>P desired (p.u.)</b>	<b>P meas. (p.u.)</b>	<b>P deviation (p.u.)</b>	<b>Response time (s)</b>
0.900	0.901	1.000	0.996	-0.004	--
0.950	0.950	1.000	0.998	-0.002	--
1.000	1.000	1.000	1.001	+0.001	--
1.020	1.020	1.000	1.001	+0.001	--
1.040	1.040	1.000	1.002	+0.002	--
1.050	1.050	1.000	1.003	+0.003	--
1.060	1.060	1.000	1.003	+0.003	--
1.070	1.070	1.000	1.003	+0.003	--
1.100	1.100	0.840	0.842	+0.002	1.8
1.120	1.120	0.594	0.590	-0.004	2.2
1.152	1.152	0.200	0.190	-0.010	2.2

**Volt-Watt Test 1**

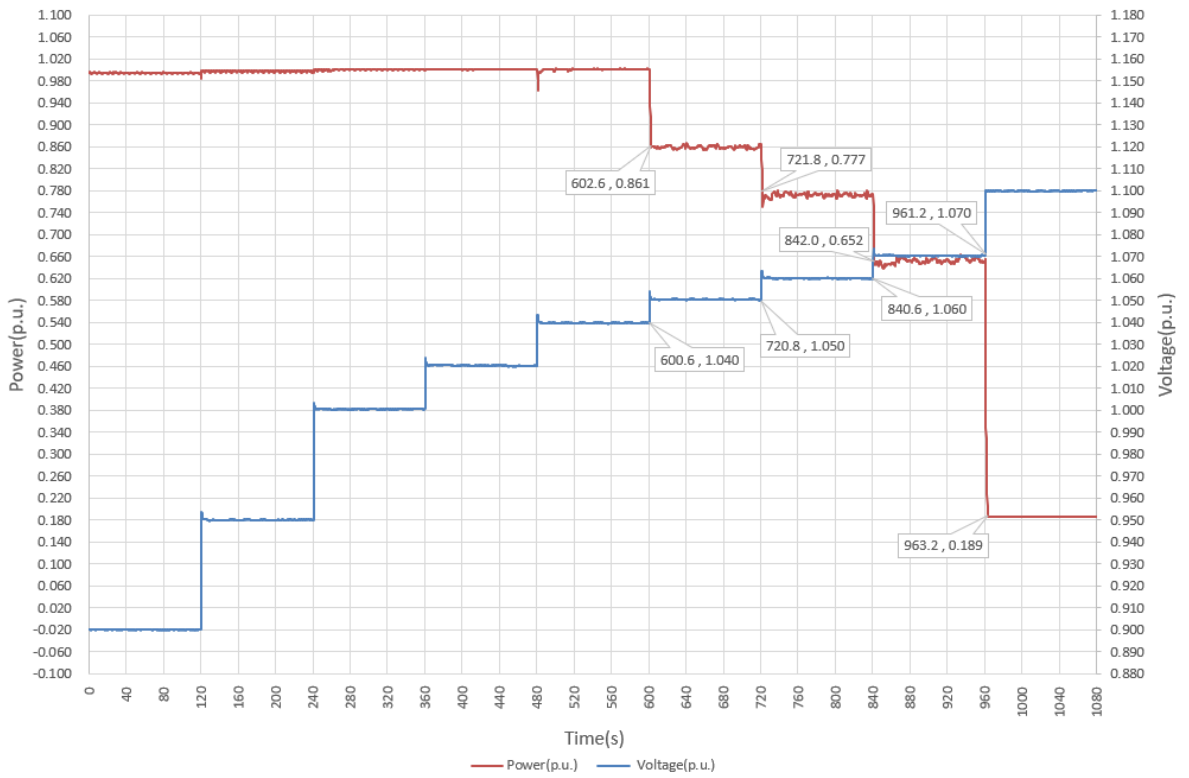

**Vatt-Watt Test 2**

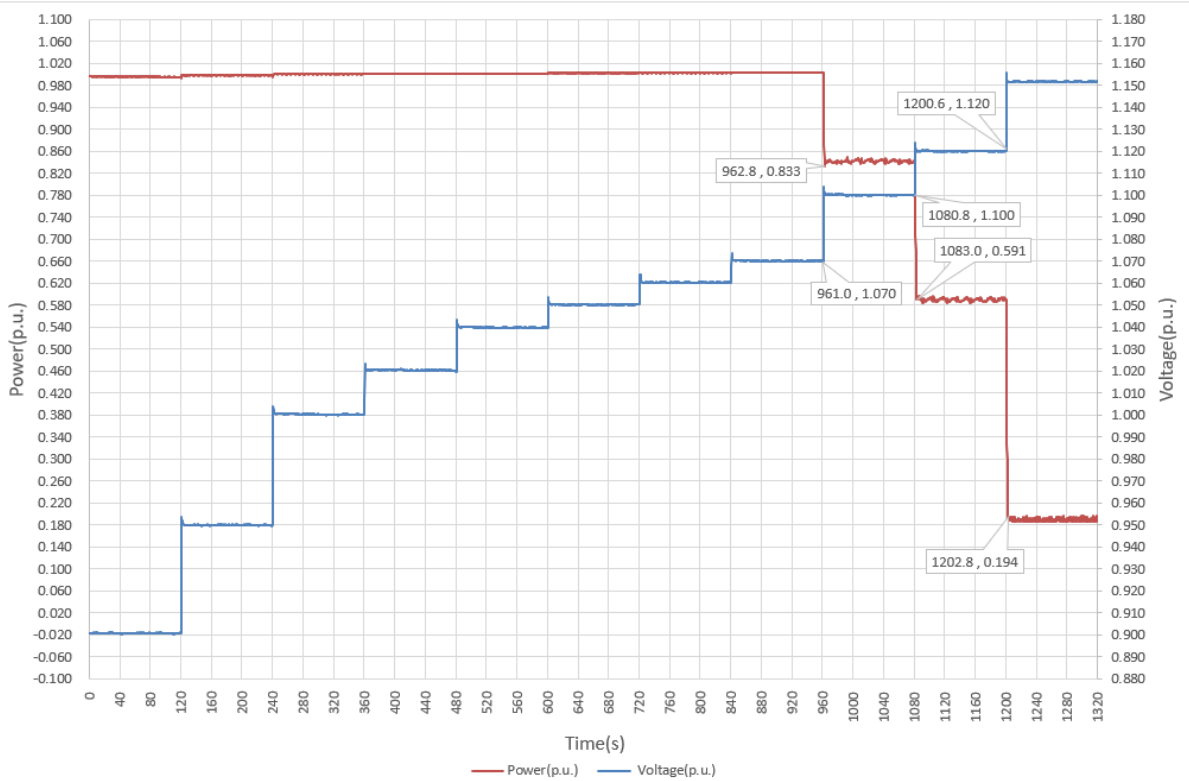

#### **4.4.4. Short circuit current requirements on generating plants**

The tests of the chapter 4.7.4 of the standard describe the required short circuit current contribution for generating plants taking into account the connection technology of the generating modules.

These tests are considered optional for Type A and Type B generating units connected to LV distribution grids, thus they have not been performed.

##### **4.4.4.1 Generating plant with non-synchronous generating technology**

###### **4.4.4.1.1 Voltage support during faults and voltage steps**

The requirements are stated in clause 4.7.4.2.1 of the standard.

The EUT is classified as Type A and B. This is no voltage support during faults and voltage steps.

###### **4.4.4.1.2 Zero current mode for converter connected generating technology**

The requirements are stated in clause 4.7.4.2.2 of the standard.

The EUT is classified as Type A and B. Refer to Section 4.2.2 and 4.2.3 of this report. During UVRT and OVRT, the EUT is always work at zero current mode.

###### **4.4.4.1.3 Induction generator based units**

The requirements are stated in clause 4.7.4.2.3 of the standard.

In general, no voltage support during faults and voltage steps is required from generating plants connected in LV distribution networks as the additional reactive current is expected to interfere with grid protection equipment. This clause is not applicable.

##### **4.4.4.2 Generating plant with synchronous generating technology - Synchronous generator based units**

The requirements are stated in clause 4.7.4.3 of the standard.

The EUT is with non-synchronous generating technology. This clause is not applicable.

#### 4.5. EMC AND POWER QUALITY

As required in clause 4.8 of the standard, all electric and electronic equipment to be installed under the scope of this standard shall be in compliance with relative standards for Electromagnetic Compatibility.

The compliances with these requirements are stated in the following EMC test reports:

EN IEC 61000-6-1: 2019; EN IEC 61000-6-2: 2019; EN 61000-6-3: 2007+A1:2011+AC2012;  
EN IEC 61000-6-4: 2019: Test Report no.BL-DG2190260-402, issued by Dongguan BALUN  
Technology Co., Ltd. on Oct.18, 2021. CNAS L14701

Note: Aside of EMC evidences of compliances, the harmonic and flicker content has been measured just to provide further information of the tested unit, and the results are stated in the following items 4.5.1 and 4.5.2 of the report.



**4.5.1. Harmonic emissions**

The test has been done according to the clause 4.8 of the standard EN 61000-3-12:2011-05

Below are the measured values of current harmonics.

Pn (%)	Phase A			Phase B			Phase C			Limit (%)
	33	66	100	33	66	100	33	66	100	
Nr./Order	I <sub>h</sub> (%)	I <sub>h</sub> (%)	I <sub>h</sub> (%)	I <sub>h</sub> (%)	I <sub>h</sub> (%)	I <sub>h</sub> (%)	I <sub>h</sub> (%)	I <sub>h</sub> (%)	I <sub>h</sub> (%)	
2	0.039	0.018	0.019	0.190	0.178	0.189	0.154	0.165	0.183	8.000
3	0.113	0.154	0.162	0.022	0.083	0.069	0.092	0.077	0.142	--
4	0.068	0.061	0.060	0.174	0.179	0.153	0.140	0.154	0.139	4.000
5	0.269	0.360	0.364	0.250	0.228	0.284	0.158	0.225	0.287	10.700
6	0.027	0.029	0.028	0.084	0.066	0.077	0.074	0.064	0.069	2.700
7	0.152	0.184	0.208	0.107	0.122	0.162	0.109	0.152	0.138	7.200
8	0.013	0.017	0.012	0.052	0.058	0.048	0.046	0.047	0.040	2.000
9	0.064	0.088	0.062	0.035	0.088	0.032	0.044	0.025	0.034	--
10	0.011	0.007	0.013	0.033	0.028	0.034	0.031	0.032	0.034	1.600
11	0.096	0.126	0.127	0.064	0.050	0.105	0.042	0.078	0.089	3.100
12	0.017	0.010	0.007	0.016	0.016	0.011	0.016	0.013	0.013	1.300
13	0.072	0.083	0.100	0.050	0.028	0.075	0.052	0.056	0.063	2.000
14	0.005	0.007	0.006	0.016	0.020	0.011	0.016	0.015	0.009	--
15	0.034	0.059	0.026	0.022	0.074	0.015	0.015	0.017	0.020	--
16	0.005	0.006	0.005	0.009	0.006	0.014	0.009	0.007	0.016	--
17	0.079	0.035	0.049	0.056	0.035	0.042	0.054	0.054	0.027	--
18	0.005	0.006	0.006	0.006	0.013	0.006	0.005	0.011	0.007	--
19	0.068	0.037	0.043	0.050	0.059	0.029	0.051	0.033	0.027	--
20	0.005	0.006	0.006	0.007	0.008	0.006	0.008	0.006	0.006	--
21	0.016	0.042	0.016	0.010	0.070	0.016	0.012	0.032	0.019	--
22	0.004	0.006	0.006	0.005	0.005	0.010	0.005	0.006	0.011	--
23	0.044	0.031	0.013	0.041	0.058	0.027	0.028	0.034	0.019	--
24	0.007	0.005	0.006	0.005	0.010	0.006	0.009	0.011	0.007	--
25	0.027	0.012	0.012	0.024	0.071	0.013	0.021	0.060	0.010	--
26	0.005	0.005	0.005	0.004	0.006	0.005	0.005	0.006	0.006	--
27	0.010	0.035	0.011	0.009	0.068	0.017	0.007	0.038	0.014	--
28	0.004	0.005	0.006	0.007	0.007	0.007	0.008	0.009	0.009	--
29	0.015	0.043	0.027	0.011	0.045	0.029	0.009	0.011	0.038	--
30	0.006	0.007	0.007	0.005	0.005	0.005	0.005	0.009	0.009	--
31	0.020	0.010	0.029	0.012	0.062	0.020	0.019	0.063	0.030	--
32	0.005	0.005	0.005	0.007	0.006	0.005	0.005	0.006	0.006	--
33	0.011	0.034	0.012	0.024	0.065	0.019	0.016	0.035	0.015	--
34	0.004	0.006	0.005	0.005	0.005	0.006	0.004	0.007	0.006	--
35	0.025	0.056	0.048	0.023	0.042	0.033	0.037	0.017	0.052	--
36	0.007	0.007	0.007	0.006	0.005	0.005	0.006	0.005	0.007	--
37	0.048	0.016	0.046	0.024	0.057	0.032	0.033	0.072	0.052	--
38	0.006	0.005	0.006	0.008	0.005	0.005	0.007	0.007	0.007	--
39	0.014	0.039	0.016	0.033	0.060	0.023	0.022	0.025	0.016	--
40	0.004	0.006	0.006	0.004	0.005	0.006	0.004	0.007	0.007	--
41	0.034	0.064	0.059	0.032	0.042	0.036	0.052	0.028	0.056	
42	0.005	0.006	0.006	0.005	0.005	0.006	0.007	0.005	0.006	
43	0.051	0.028	0.049	0.030	0.044	0.035	0.032	0.073	0.057	
44	0.005	0.004	0.005	0.005	0.005	0.005	0.006	0.005	0.005	
45	0.016	0.043	0.020	0.026	0.054	0.027	0.013	0.018	0.014	
46	0.009	0.011	0.011	0.010	0.011	0.011	0.010	0.011	0.012	
47	0.030	0.066	0.068	0.023	0.044	0.038	0.043	0.027	0.054	

Pn (%)	Phase A			Phase B			Phase C			Limit (%)
	33	66	100	33	66	100	33	66	100	
Nr./Order	I <sub>h</sub> (%)	I <sub>h</sub> (%)	I <sub>h</sub> (%)	I <sub>h</sub> (%)	I <sub>h</sub> (%)	I <sub>h</sub> (%)	I <sub>h</sub> (%)	I <sub>h</sub> (%)	I <sub>h</sub> (%)	
48	0.012	0.012	0.012	0.010	0.011	0.011	0.012	0.012	0.012	
49	0.036	0.041	0.056	0.029	0.043	0.039	0.022	0.082	0.067	
50	0.005	0.006	0.006	0.004	0.005	0.006	0.004	0.006	0.005	
THD (%)	0.177	0.197	0.192	0.140	0.244	0.147	0.145	0.203	0.175	13.000
PWHD(%)	0.677	0.953	0.941	0.573	1.174	0.679	0.663	1.089	0.977	22.000

**Current Harmonics**

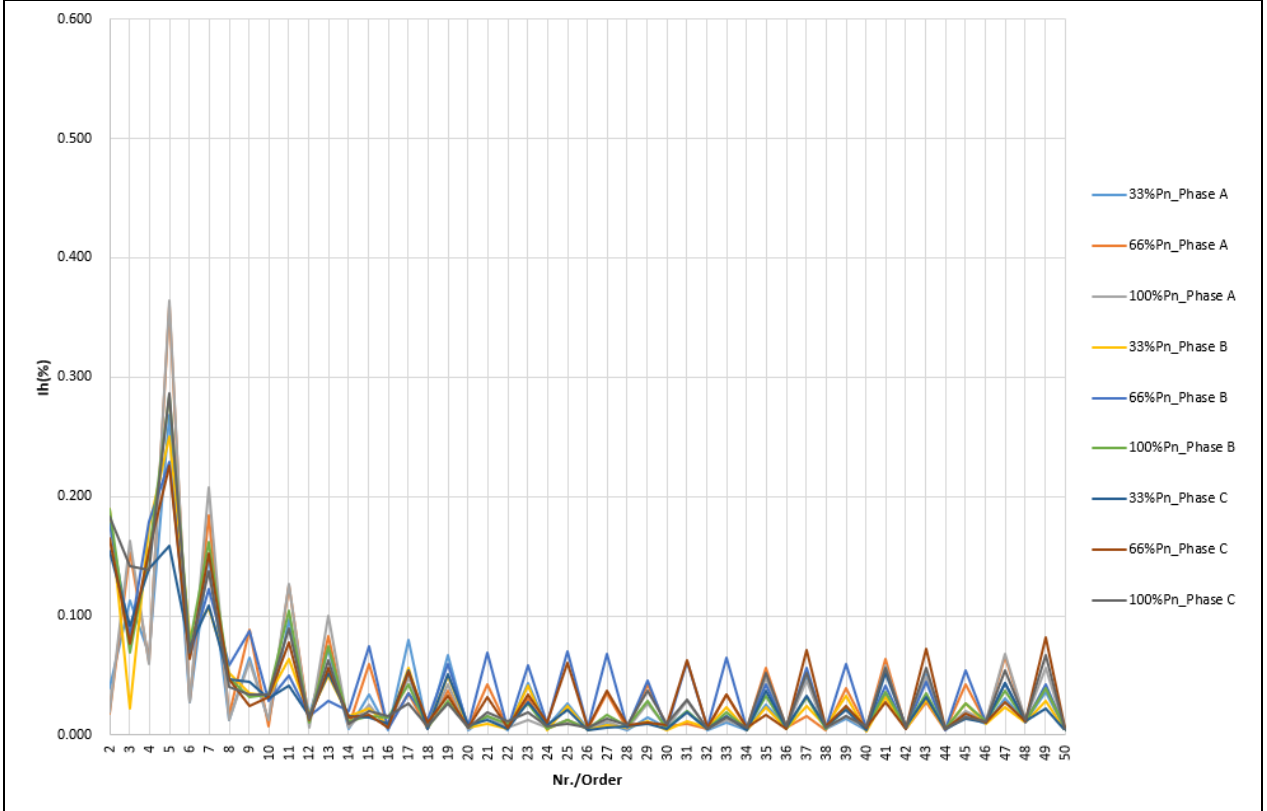

**THD and PWHD**

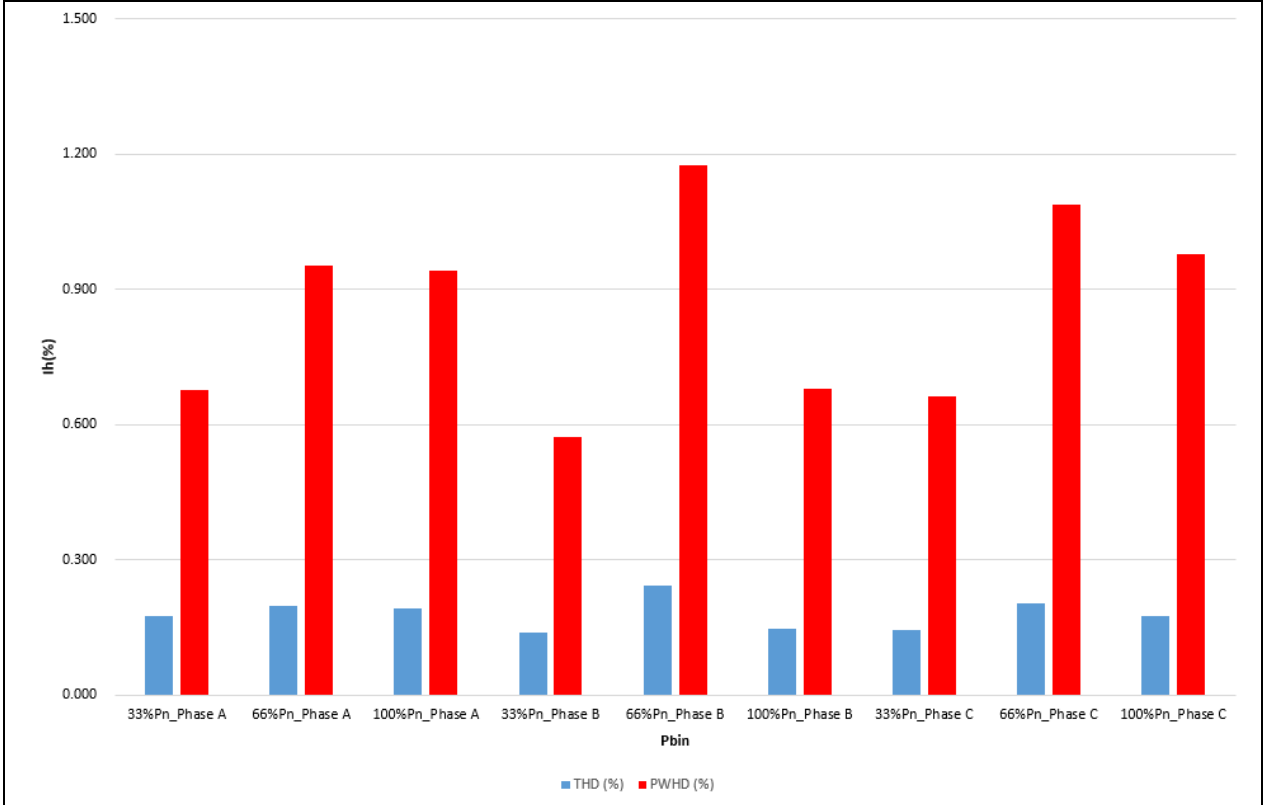

#### 4.5.2. Flicker and voltage fluctuations

The test has been done according to the clause 4.8 of the standard.

The measurements of voltage fluctuations have been measured at 33%, 66% and 100% of the nominal power value of the inverter according to the standard IEC 61000-3-11:2017.

The flicker test result as following:

33 %Pn				
Item	Limit	Phase A	Phase B	Phase C
P <sub>ST</sub>	≤ 1.000	0.086	0.103	0.126
P <sub>LT</sub>	≤ 0.650	0.085	0.101	0.124
dc [%]	≤ 3.300	0.073	0.062	0.042
dmax [%]	4.000	0.172	0.198	0.174

66 %Pn				
Item	Limit	Phase A	Phase B	Phase C
P <sub>ST</sub>	≤ 1.000	0.057	0.069	0.085
P <sub>LT</sub>	≤ 0.650	0.056	0.068	0.084
dc [%]	≤ 3.300	0.070	0.067	0.059
dmax [%]	4.000	0.146	0.154	0.175

100%Pn				
Item	Limit	Phase A	Phase B	Phase C
P <sub>ST</sub>	≤ 1.000	0.118	0.034	0.045
P <sub>LT</sub>	≤ 0.650	0.116	0.030	0.042
dc [%]	≤ 3.300	0.094	0.096	0.094
dmax [%]	4.000	0.193	0.184	0.264

As it can be seen in the next screenshots, this test has 12 steps. The values took of Pst, Plt, dc and dmax are the most unfavorable of the 12 steps.

### 33 %Pn

#### Phase A

Flicker Mode  
Flicker

Range Over

U1	U2	U3	U4	U5	U6	U7
I1	I2	I3	I4	I5	I6	I7

SCL  Line Filter

AVG  Freq Filter

CH: 1 2 3

4 5 6 7

Count 12/12 Complete

Interval 00:00s/10:00s

Element 1

Volt Range 300 V/60Hz

Un (U1) 230.108V

Freq (U1) 50.000Hz

Dmin 0.10%

Element1 Judgement Pass

Total Judgement Pass

(Element1,2,3)

	dc[%]	dmax[%]	d(t)[ms]	Pst	Plt
Limit	3.30	4.00	500 3.30%	1.00	0.65 N:12
No. 1	0.065	Pass 0.171	Pass 0.0	Pass 0.083	Pass
2	0.060	Pass 0.160	Pass 0.0	Pass 0.084	Pass
3	0.069	Pass 0.161	Pass 0.0	Pass 0.084	Pass
4	0.066	Pass 0.157	Pass 0.0	Pass 0.085	Pass
5	0.069	Pass 0.161	Pass 0.0	Pass 0.086	Pass
6	0.071	Pass 0.166	Pass 0.0	Pass 0.085	Pass
7	0.066	Pass 0.154	Pass 0.0	Pass 0.086	Pass
8	0.062	Pass 0.159	Pass 0.0	Pass 0.086	Pass
9	0.068	Pass 0.172	Pass 0.0	Pass 0.086	Pass
10	0.062	Pass 0.164	Pass 0.0	Pass 0.086	Pass
11	0.061	Pass 0.169	Pass 0.0	Pass 0.086	Pass
12	0.073	Pass 0.153	Pass 0.0	Pass 0.086	Pass
Result	Pass	Pass	Pass	Pass	0.085 Pass

Update: 3643

Runtime: 5:05:32

2021-08-10 13:43:51

ΣA[3P4W]

U1 300 V  
I1 50 A  
Sync Src: U1  
Integral: Reset

U2 600 V  
I2 50 A  
Sync Src: U1  
Integral: Reset

U3 600 V  
I3 50 A  
Sync Src: U1  
Integral: Reset

Element 4

U4 1000 V  
I4 50 mV  
Sync Src: U1  
Integral: Reset

Element 5

U5 30 V  
I5 50 A  
Sync Src: U1  
Integral: Reset

### Phase B

Flicker Mode  
Flicker

Range Over

U1	U2	U3	U4	U5	U6	U7
I1	I2	I3	I4	I5	I6	I7

SCL  Line Filter

AVG  Freq Filter

PA\_00000.png

CH: 1 2 3

4 5 6 7

Count 12/12 Complete

Interval 00:00s/10:00s

Element 2

Volt Range 600 V/60Hz

Un (U2) 230.075V

Freq (U2) 50.000Hz

Dmin 0.10%

Element2 Judgement Pass

Total Judgement Pass

(Element1,2,3)

	dc[%]	dmax[%]	d(t)[ms]	Pst	Plt
Limit	3.30	4.00	500 3.30%	1.00	0.65 N:12
No. 1	0.050	Pass 0.168	Pass 0.0	Pass 0.099	Pass
2	0.048	Pass 0.178	Pass 0.0	Pass 0.100	Pass
3	0.050	Pass 0.173	Pass 0.0	Pass 0.101	Pass
4	0.049	Pass 0.185	Pass 0.0	Pass 0.102	Pass
5	0.049	Pass 0.183	Pass 0.0	Pass 0.102	Pass
6	0.055	Pass 0.183	Pass 0.0	Pass 0.101	Pass
7	0.051	Pass 0.186	Pass 0.0	Pass 0.102	Pass
8	0.042	Pass 0.187	Pass 0.0	Pass 0.102	Pass
9	0.062	Pass 0.198	Pass 0.0	Pass 0.102	Pass
10	0.040	Pass 0.184	Pass 0.0	Pass 0.102	Pass
11	0.055	Pass 0.191	Pass 0.0	Pass 0.102	Pass
12	0.056	Pass 0.181	Pass 0.0	Pass 0.103	Pass
Result	Pass	Pass	Pass	Pass	0.101 Pass

Update: 3648

Runtime: 5:05:41

2021-08-10 13:44:00

ΣA[3P4W]

U1 300 V  
I1 50 A  
Sync Src: U1  
Integral: Reset

U2 600 V  
I2 50 A  
Sync Src: U1  
Integral: Reset

U3 600 V  
I3 50 A  
Sync Src: U1  
Integral: Reset

Element 4

U4 1000 V  
I4 50 mV  
Sync Src: U1  
Integral: Reset

Element 5

U5 30 V  
I5 50 A  
Sync Src: U1  
Integral: Reset

**Phase C**

Flicker Mode  
Flicker

Range Over

U1	U2	U3	U4	U5	U6	U7
I1	I2	I3	I4	I5	I6	I7

SCL

Line Filter

PA\_00001.png

CH: 1 2 3  
4 5 6 7

Count 12/12 Complete

Interval 00:00s/10:00s

Element 3

Volt Range 600 V/60Hz      Element3      Judgement Pass

Un (U3) 230.115V      Total      Judgement Pass

Freq (U3) 50.000Hz      (Element1,2,3)

Dmin 0.10%

	dc[%]	dmax[%]	d(t)[ms]	Pst	Plt
Limit	3.30	4.00	500 3.30%	1.00	0.65 N:12
No. 1	0.039	Pass 0.169	Pass 0.0	Pass 0.121	Pass
2	0.041	Pass 0.161	Pass 0.0	Pass 0.123	Pass
3	0.041	Pass 0.169	Pass 0.0	Pass 0.123	Pass
4	0.037	Pass 0.166	Pass 0.0	Pass 0.125	Pass
5	0.030	Pass 0.161	Pass 0.0	Pass 0.124	Pass
6	0.028	Pass 0.160	Pass 0.0	Pass 0.124	Pass
7	0.038	Pass 0.173	Pass 0.0	Pass 0.125	Pass
8	0.030	Pass 0.174	Pass 0.0	Pass 0.124	Pass
9	0.040	Pass 0.167	Pass 0.0	Pass 0.125	Pass
10	0.036	Pass 0.168	Pass 0.0	Pass 0.125	Pass
11	0.042	Pass 0.164	Pass 0.0	Pass 0.125	Pass
12	0.029	Pass 0.170	Pass 0.0	Pass 0.126	Pass
Result	Pass	Pass	Pass	Pass	0.124 Pass

Update: 3652      Runtime: 5:05:51      2021-08-10 13:44:10

**66 %Pn**

**Phase A**

Flicker Mode  
Flicker

Range Over

U1	U2	U3	U4	U5	U6	U7
I1	I2	I3	I4	I5	I6	I7

SCL

Line Filter

AVG  Freq Filter

CH: 1 2 3  
4 5 6 7

Count 12/12 Complete

Interval 00:00s/10:00s

Element 1

Volt Range 300 V/60Hz      Element1      Judgement Pass

Un (U1) 230.555V      Total      Judgement Pass

Freq (U1) 50.000Hz      (Element1,2,3)

Dmin 0.10%

	dc[%]	dmax[%]	d(t)[ms]	Pst	Plt
Limit	3.30	4.00	500 3.30%	1.00	0.65 N:12
No. 1	0.060	Pass 0.119	Pass 0.0	Pass 0.056	Pass
2	0.065	Pass 0.146	Pass 0.0	Pass 0.057	Pass
3	0.057	Pass 0.135	Pass 0.0	Pass 0.056	Pass
4	0.057	Pass 0.126	Pass 0.0	Pass 0.056	Pass
5	0.060	Pass 0.124	Pass 0.0	Pass 0.056	Pass
6	0.056	Pass 0.132	Pass 0.0	Pass 0.056	Pass
7	0.062	Pass 0.117	Pass 0.0	Pass 0.055	Pass
8	0.070	Pass 0.130	Pass 0.0	Pass 0.056	Pass
9	0.061	Pass 0.126	Pass 0.0	Pass 0.056	Pass
10	0.064	Pass 0.124	Pass 0.0	Pass 0.057	Pass
11	0.063	Pass 0.145	Pass 0.0	Pass 0.057	Pass
12	0.061	Pass 0.129	Pass 0.0	Pass 0.056	Pass
Result	Pass	Pass	Pass	Pass	0.056 Pass

Update: 4028      Runtime: 10:54:13      2021-08-09 19:47:03

### Phase B

Flicker Mode  
Flicker

Range Over

U1	U2	U3	U4	U5	U6	U7
I1	I2	I3	I4	I5	I6	I7

SCL  Line Filter   
 AVG  Freq Filter

PA\_00003.png

CH: 1 2 3  
4 5 6 7

Count 12/12 Complete

Interval 00:00s/10:00s

Element 2

Volt Range 600 V/60Hz      Element2      Judgement Pass

Un (U2) 230.462V      Total      Judgement Pass

Freq (U2) 50.001Hz      (Element1,2,3)

Dmin 0.10%

	dc[%]	dmax[%]	d(t)[ms]	Pst	Plt
Limit	3.30	4.00	500 3.30%	1.00	0.65 N:12
No. 1	0.051 <span style="color: green;">Pass</span>	0.136 <span style="color: green;">Pass</span>	0.0 <span style="color: green;">Pass</span>	0.068 <span style="color: green;">Pass</span>	
2	0.067 <span style="color: green;">Pass</span>	0.145 <span style="color: green;">Pass</span>	0.0 <span style="color: green;">Pass</span>	0.068 <span style="color: green;">Pass</span>	
3	0.050 <span style="color: green;">Pass</span>	0.154 <span style="color: green;">Pass</span>	0.0 <span style="color: green;">Pass</span>	0.068 <span style="color: green;">Pass</span>	
4	0.060 <span style="color: green;">Pass</span>	0.140 <span style="color: green;">Pass</span>	0.0 <span style="color: green;">Pass</span>	0.069 <span style="color: green;">Pass</span>	
5	0.052 <span style="color: green;">Pass</span>	0.129 <span style="color: green;">Pass</span>	0.0 <span style="color: green;">Pass</span>	0.068 <span style="color: green;">Pass</span>	
6	0.059 <span style="color: green;">Pass</span>	0.130 <span style="color: green;">Pass</span>	0.0 <span style="color: green;">Pass</span>	0.069 <span style="color: green;">Pass</span>	
7	0.058 <span style="color: green;">Pass</span>	0.146 <span style="color: green;">Pass</span>	0.0 <span style="color: green;">Pass</span>	0.068 <span style="color: green;">Pass</span>	
8	0.054 <span style="color: green;">Pass</span>	0.133 <span style="color: green;">Pass</span>	0.0 <span style="color: green;">Pass</span>	0.069 <span style="color: green;">Pass</span>	
9	0.047 <span style="color: green;">Pass</span>	0.133 <span style="color: green;">Pass</span>	0.0 <span style="color: green;">Pass</span>	0.068 <span style="color: green;">Pass</span>	
10	0.056 <span style="color: green;">Pass</span>	0.138 <span style="color: green;">Pass</span>	0.0 <span style="color: green;">Pass</span>	0.069 <span style="color: green;">Pass</span>	
11	0.051 <span style="color: green;">Pass</span>	0.135 <span style="color: green;">Pass</span>	0.0 <span style="color: green;">Pass</span>	0.069 <span style="color: green;">Pass</span>	
12	0.064 <span style="color: green;">Pass</span>	0.138 <span style="color: green;">Pass</span>	0.0 <span style="color: green;">Pass</span>	0.069 <span style="color: green;">Pass</span>	
Result	<span style="color: green;">Pass</span>	<span style="color: green;">Pass</span>	<span style="color: green;">Pass</span>	<span style="color: green;">Pass</span>	0.068 <span style="color: green;">Pass</span>

Update: 4032      Runtime: 10:54:19      2021-08-09 19:47:09

ΣA(3P4W)

U1 300 V  
I1 500 mA  
Sync Src: U1  
Integral: Reset

U2 600 V  
I2 500 mA  
Sync Src: U1  
Integral: Reset

U3 600 V  
I3 500 mA  
Sync Src: U1  
Integral: Reset

Element 4

U4 1000 V  
I4 50 mA  
Sync Src: U1  
Integral: Reset

Element 5

U5 30 V  
I5 50 A  
Sync Src: U1  
Integral: Reset

### Phase C

Flicker Mode  
Flicker

Range Over

U1	U2	U3	U4	U5	U6	U7
I1	I2	I3	I4	I5	I6	I7

SCL  Line Filter   
 AVG  Freq Filter

PA\_00004.png

CH: 1 2 3  
4 5 6 7

Count 12/12 Complete

Interval 00:00s/10:00s

Element 3

Volt Range 600 V/60Hz      Element3      Judgement Pass

Un (U3) 230.516V      Total      Judgement Pass

Freq (U3) 50.001Hz      (Element1,2,3)

Dmin 0.10%

	dc[%]	dmax[%]	d(t)[ms]	Pst	Plt
Limit	3.30	4.00	500 3.30%	1.00	0.65 N:12
No. 1	0.031 <span style="color: green;">Pass</span>	0.137 <span style="color: green;">Pass</span>	0.0 <span style="color: green;">Pass</span>	0.083 <span style="color: green;">Pass</span>	
2	0.031 <span style="color: green;">Pass</span>	0.138 <span style="color: green;">Pass</span>	0.0 <span style="color: green;">Pass</span>	0.083 <span style="color: green;">Pass</span>	
3	0.046 <span style="color: green;">Pass</span>	0.140 <span style="color: green;">Pass</span>	0.0 <span style="color: green;">Pass</span>	0.084 <span style="color: green;">Pass</span>	
4	0.042 <span style="color: green;">Pass</span>	0.136 <span style="color: green;">Pass</span>	0.0 <span style="color: green;">Pass</span>	0.084 <span style="color: green;">Pass</span>	
5	0.038 <span style="color: green;">Pass</span>	0.140 <span style="color: green;">Pass</span>	0.0 <span style="color: green;">Pass</span>	0.084 <span style="color: green;">Pass</span>	
6	0.040 <span style="color: green;">Pass</span>	0.134 <span style="color: green;">Pass</span>	0.0 <span style="color: green;">Pass</span>	0.083 <span style="color: green;">Pass</span>	
7	0.059 <span style="color: green;">Pass</span>	0.175 <span style="color: green;">Pass</span>	0.0 <span style="color: green;">Pass</span>	0.084 <span style="color: green;">Pass</span>	
8	0.044 <span style="color: green;">Pass</span>	0.146 <span style="color: green;">Pass</span>	0.0 <span style="color: green;">Pass</span>	0.084 <span style="color: green;">Pass</span>	
9	0.043 <span style="color: green;">Pass</span>	0.143 <span style="color: green;">Pass</span>	0.0 <span style="color: green;">Pass</span>	0.084 <span style="color: green;">Pass</span>	
10	0.033 <span style="color: green;">Pass</span>	0.137 <span style="color: green;">Pass</span>	0.0 <span style="color: green;">Pass</span>	0.084 <span style="color: green;">Pass</span>	
11	0.031 <span style="color: green;">Pass</span>	0.139 <span style="color: green;">Pass</span>	0.0 <span style="color: green;">Pass</span>	0.085 <span style="color: green;">Pass</span>	
12	0.032 <span style="color: green;">Pass</span>	0.145 <span style="color: green;">Pass</span>	0.0 <span style="color: green;">Pass</span>	0.085 <span style="color: green;">Pass</span>	
Result	<span style="color: green;">Pass</span>	<span style="color: green;">Pass</span>	<span style="color: green;">Pass</span>	<span style="color: green;">Pass</span>	0.084 <span style="color: green;">Pass</span>

Update: 4035      Runtime: 10:54:26      2021-08-09 19:47:16

ΣA(3P4W)

U1 300 V  
I1 500 mA  
Sync Src: U1  
Integral: Reset

U2 600 V  
I2 500 mA  
Sync Src: U1  
Integral: Reset

U3 600 V  
I3 500 mA  
Sync Src: U1  
Integral: Reset

Element 4

U4 1000 V  
I4 50 mA  
Sync Src: U1  
Integral: Reset

Element 5

U5 30 V  
I5 50 A  
Sync Src: U1  
Integral: Reset

**100 %Pn**

**Phase A**

Flicker Mode: Flicker

Range Over: U1 U2 U3 U4 U5 U6 U7  
I1 I2 I3 I4 I5 I6 I7

SCL  Line Filter

AVG  Freq Filter

CH: 1 2 3  
4 5 6 7

Count: 12/12 Complete

Interval: 00:00s/10:00s

Element: 1

Volt Range: 600 V/50Hz

Un (U1): 230.571V

Freq (U1): 50.000Hz

Dmin: 0.10%

Element1 Judgement: Pass

Total Judgement: Pass

(Element1,2,3)

	dc[%]	dmax[%]	d(t)[ms]	Pst	Plt
Limit	3.30	4.00	500 3.30%	1.00	0.65 N:12
No. 1	0.087 <span style="color: green;">Pass</span>	0.180 <span style="color: green;">Pass</span>	0.0 <span style="color: green;">Pass</span>	0.114 <span style="color: green;">Pass</span>	
2	0.093 <span style="color: green;">Pass</span>	0.180 <span style="color: green;">Pass</span>	0.0 <span style="color: green;">Pass</span>	0.114 <span style="color: green;">Pass</span>	
3	0.085 <span style="color: green;">Pass</span>	0.183 <span style="color: green;">Pass</span>	0.0 <span style="color: green;">Pass</span>	0.115 <span style="color: green;">Pass</span>	
4	0.071 <span style="color: green;">Pass</span>	0.139 <span style="color: green;">Pass</span>	0.0 <span style="color: green;">Pass</span>	0.114 <span style="color: green;">Pass</span>	
5	0.064 <span style="color: green;">Pass</span>	0.171 <span style="color: green;">Pass</span>	0.0 <span style="color: green;">Pass</span>	0.115 <span style="color: green;">Pass</span>	
6	0.067 <span style="color: green;">Pass</span>	0.160 <span style="color: green;">Pass</span>	0.0 <span style="color: green;">Pass</span>	0.117 <span style="color: green;">Pass</span>	
7	0.083 <span style="color: green;">Pass</span>	0.185 <span style="color: green;">Pass</span>	0.0 <span style="color: green;">Pass</span>	0.116 <span style="color: green;">Pass</span>	
8	0.084 <span style="color: green;">Pass</span>	0.184 <span style="color: green;">Pass</span>	0.0 <span style="color: green;">Pass</span>	0.117 <span style="color: green;">Pass</span>	
9	0.077 <span style="color: green;">Pass</span>	0.193 <span style="color: green;">Pass</span>	0.0 <span style="color: green;">Pass</span>	0.118 <span style="color: green;">Pass</span>	
10	0.069 <span style="color: green;">Pass</span>	0.144 <span style="color: green;">Pass</span>	0.0 <span style="color: green;">Pass</span>	0.117 <span style="color: green;">Pass</span>	
11	0.094 <span style="color: green;">Pass</span>	0.192 <span style="color: green;">Pass</span>	0.0 <span style="color: green;">Pass</span>	0.116 <span style="color: green;">Pass</span>	
12	0.053 <span style="color: green;">Pass</span>	0.132 <span style="color: green;">Pass</span>	0.0 <span style="color: green;">Pass</span>	0.115 <span style="color: green;">Pass</span>	
Result	<span style="color: green;">Pass</span>	<span style="color: green;">Pass</span>	<span style="color: green;">Pass</span>	<span style="color: green;">Pass</span>	0.116 <span style="color: green;">Pass</span>

Update: 3714

Runtime: 5:03:00

38% 44% x2
2021-09-01 13:32:22

ΣA(3P4W)  
U1 600 V  
I1 5 V  
Sync Src: U1  
Integral: Reset  
U2 600 V  
I2 5 V  
Sync Src: U1  
Integral: Reset  
U3 600 V  
I3 5 V  
Sync Src: U1  
Integral: Reset

Element 4  
U4 1000 V  
I4 50 A  
Sync Src: U1  
Integral: Reset

Element 5  
U5 1000 V  
I5 50 A  
Sync Src: U1  
Integral: Reset

**Phase B**

Flicker Mode: Flicker

Range Over: U1 U2 U3 U4 U5 U6 U7  
I1 I2 I3 I4 I5 I6 I7

SCL  Line Filter

AVG  Freq Filter

CH: 1 2 3  
4 5 6 7

Count: 12/12 Complete

Interval: 00:00s/10:00s

Element: 2

Volt Range: 600 V/50Hz

Un (U2): 230.467V

Freq (U2): 50.000Hz

Dmin: 0.10%

Element2 Judgement: Pass

Total Judgement: Pass

(Element1,2,3)

	dc[%]	dmax[%]	d(t)[ms]	Pst	Plt
Limit	3.30	4.00	500 3.30%	1.00	0.65 N:12
No. 1	0.077 <span style="color: green;">Pass</span>	0.132 <span style="color: green;">Pass</span>	0.0 <span style="color: green;">Pass</span>	0.023 <span style="color: green;">Pass</span>	
2	0.081 <span style="color: green;">Pass</span>	0.171 <span style="color: green;">Pass</span>	0.0 <span style="color: green;">Pass</span>	0.025 <span style="color: green;">Pass</span>	
3	0.067 <span style="color: green;">Pass</span>	0.126 <span style="color: green;">Pass</span>	0.0 <span style="color: green;">Pass</span>	0.029 <span style="color: green;">Pass</span>	
4	0.093 <span style="color: green;">Pass</span>	0.184 <span style="color: green;">Pass</span>	0.0 <span style="color: green;">Pass</span>	0.028 <span style="color: green;">Pass</span>	
5	0.082 <span style="color: green;">Pass</span>	0.148 <span style="color: green;">Pass</span>	0.0 <span style="color: green;">Pass</span>	0.029 <span style="color: green;">Pass</span>	
6	0.082 <span style="color: green;">Pass</span>	0.145 <span style="color: green;">Pass</span>	0.0 <span style="color: green;">Pass</span>	0.032 <span style="color: green;">Pass</span>	
7	0.089 <span style="color: green;">Pass</span>	0.127 <span style="color: green;">Pass</span>	0.0 <span style="color: green;">Pass</span>	0.034 <span style="color: green;">Pass</span>	
8	0.096 <span style="color: green;">Pass</span>	0.128 <span style="color: green;">Pass</span>	0.0 <span style="color: green;">Pass</span>	0.032 <span style="color: green;">Pass</span>	
9	0.086 <span style="color: green;">Pass</span>	0.123 <span style="color: green;">Pass</span>	0.0 <span style="color: green;">Pass</span>	0.034 <span style="color: green;">Pass</span>	
10	0.091 <span style="color: green;">Pass</span>	0.123 <span style="color: green;">Pass</span>	0.0 <span style="color: green;">Pass</span>	0.032 <span style="color: green;">Pass</span>	
11	0.094 <span style="color: green;">Pass</span>	0.149 <span style="color: green;">Pass</span>	0.0 <span style="color: green;">Pass</span>	0.028 <span style="color: green;">Pass</span>	
12	0.096 <span style="color: green;">Pass</span>	0.144 <span style="color: green;">Pass</span>	0.0 <span style="color: green;">Pass</span>	0.029 <span style="color: green;">Pass</span>	
Result	<span style="color: green;">Pass</span>	<span style="color: green;">Pass</span>	<span style="color: green;">Pass</span>	<span style="color: green;">Pass</span>	0.030 <span style="color: green;">Pass</span>

Update: 3718

Runtime: 5:03:08

38% 44% x2
2021-09-01 13:32:30

ΣA(3P4W)  
U1 600 V  
I1 5 V  
Sync Src: U1  
Integral: Reset  
U2 600 V  
I2 5 V  
Sync Src: U1  
Integral: Reset  
U3 600 V  
I3 5 V  
Sync Src: U1  
Integral: Reset

Element 4  
U4 1000 V  
I4 50 A  
Sync Src: U1  
Integral: Reset

Element 5  
U5 1000 V  
I5 50 A  
Sync Src: U1  
Integral: Reset



### Phase C

Flicker Mode  
Flicker

Range Over

U1	U2	U3	U4	U5	U6	U7
I1	I2	I3	I4	I5	I6	I7

SCL

Line Filter

AVG

Freq Filter

PA\_00001.tif

CH: 1 2 3

4 5 6 7

Count 12/12 Complete

Interval 00:00s/10:00s

Element 3

Volt Range 600 V/50Hz

Un (U3) 230.581V

Freq (U3) 50.000Hz

Dmin 0.10%

Element3

Judgement Pass

Total

Judgement Pass

(Element1,2,3)

	dc[%]	dmax[%]	d(t)[ms]	Pst	Plt
Limit	3.30	4.00	500 3.30%	1.00	0.65 N:12
No. 1	0.078 <span style="color: green;">Pass</span>	0.136 <span style="color: green;">Pass</span>	0.0 <span style="color: green;">Pass</span>	0.038 <span style="color: green;">Pass</span>	
2	0.086 <span style="color: green;">Pass</span>	0.198 <span style="color: green;">Pass</span>	0.0 <span style="color: green;">Pass</span>	0.040 <span style="color: green;">Pass</span>	
3	0.087 <span style="color: green;">Pass</span>	0.131 <span style="color: green;">Pass</span>	0.0 <span style="color: green;">Pass</span>	0.040 <span style="color: green;">Pass</span>	
4	0.091 <span style="color: green;">Pass</span>	0.160 <span style="color: green;">Pass</span>	0.0 <span style="color: green;">Pass</span>	0.039 <span style="color: green;">Pass</span>	
5	0.086 <span style="color: green;">Pass</span>	0.131 <span style="color: green;">Pass</span>	0.0 <span style="color: green;">Pass</span>	0.040 <span style="color: green;">Pass</span>	
6	0.079 <span style="color: green;">Pass</span>	0.127 <span style="color: green;">Pass</span>	0.0 <span style="color: green;">Pass</span>	0.042 <span style="color: green;">Pass</span>	
7	0.072 <span style="color: green;">Pass</span>	0.122 <span style="color: green;">Pass</span>	0.0 <span style="color: green;">Pass</span>	0.044 <span style="color: green;">Pass</span>	
8	0.092 <span style="color: green;">Pass</span>	0.125 <span style="color: green;">Pass</span>	0.0 <span style="color: green;">Pass</span>	0.045 <span style="color: green;">Pass</span>	
9	0.094 <span style="color: green;">Pass</span>	0.123 <span style="color: green;">Pass</span>	0.0 <span style="color: green;">Pass</span>	0.045 <span style="color: green;">Pass</span>	
10	0.092 <span style="color: green;">Pass</span>	0.264 <span style="color: green;">Pass</span>	0.0 <span style="color: green;">Pass</span>	0.043 <span style="color: green;">Pass</span>	
11	0.082 <span style="color: green;">Pass</span>	0.131 <span style="color: green;">Pass</span>	0.0 <span style="color: green;">Pass</span>	0.042 <span style="color: green;">Pass</span>	
12	0.089 <span style="color: green;">Pass</span>	0.124 <span style="color: green;">Pass</span>	0.0 <span style="color: green;">Pass</span>	0.040 <span style="color: green;">Pass</span>	
Result	<span style="color: green;">Pass</span>	<span style="color: green;">Pass</span>	<span style="color: green;">Pass</span>	<span style="color: green;">Pass</span>	0.042 <span style="color: green;">Pass</span>

Update: 3721

Runtime: 5:03:15

38%  
114%  
2021-09-01  
13:32:36

ΣA(3P4W)  
U1 600 V  
I1 5 V  
Sync Src: U1  
Integral: Reset  
U2 600 V  
I2 5 V  
Sync Src: U1  
Integral: Reset  
U3 600 V  
I3 5 V  
Sync Src: U1  
Integral: Reset  
Element 4  
U4 1000 V  
I4 50 A  
Sync Src: U1  
Integral: Reset  
Element 5  
U5 1000 V  
I5 50 A  
Sync Src: U1  
Integral: Reset

#### 4.6. INTERFACE PROTECTION

##### 4.6.1. Requirements on voltage and frequency protection (Country / Region included in the default settings: Greece and Turkey)

The test has been done according to the clause 4.9.3 of the standard. The minimum required accuracy for protection is:

- For frequency measurement  $\pm 0.05$  Hz;
- For voltage measurement  $\pm 1$  %Un.
- The reset time shall be  $\leq 50$  ms.
- The interface protection relay shall not conduct continuous starting and disengaging operations of the interface protection relay. Therefore, a reasonable reset ratio shall be implemented which shall not be zero but be below 2 % of nominal value for voltage and below 0.2 Hz for frequency.

##### 4.6.1.1 Undervoltage protection

Undervoltage protection may be implemented with two completely independent protection thresholds, each one able to be activated or not. The standard adjustment ranges are as follows.

Undervoltage threshold stage 1 [27 <]:

- Threshold (0.2 – 1) Un adjustable by steps of 0.01 Un
- Operate time (0.1 – 100) s adjustable in steps of 0.1 s

Undervoltage threshold stage 2 [27 <<]:

- Threshold (0.2 – 1) Un adjustable by steps of 0.01 Un
- Operate time (0.1 – 5) s adjustable in steps of 0.05 s

The undervoltage threshold stage 2 is not applicable for micro-generating plants.

The following definitions apply to the test to verify the clause:

Undervoltage	Test No.	Voltage setting (p.u.)	Voltage meas. (p.u.)	Voltage deviation (p.u.)	Trip time setting (s)	Trip time meas. (s)	Trip time deviation (s)
Stage 1 [27 <]	1	0.200	0.197	-0.003	100.000	100.000	0.000
	2	1.000	1.006	+0.006	0.100	0.091	-0.009
Stage 2 [27 <<]	3	0.200	0.202	+0.002	5.000	4.990	-0.010
	4	1.000	1.002	+0.002	0.100	0.075	-0.025

Test results are represented at diagrams below.

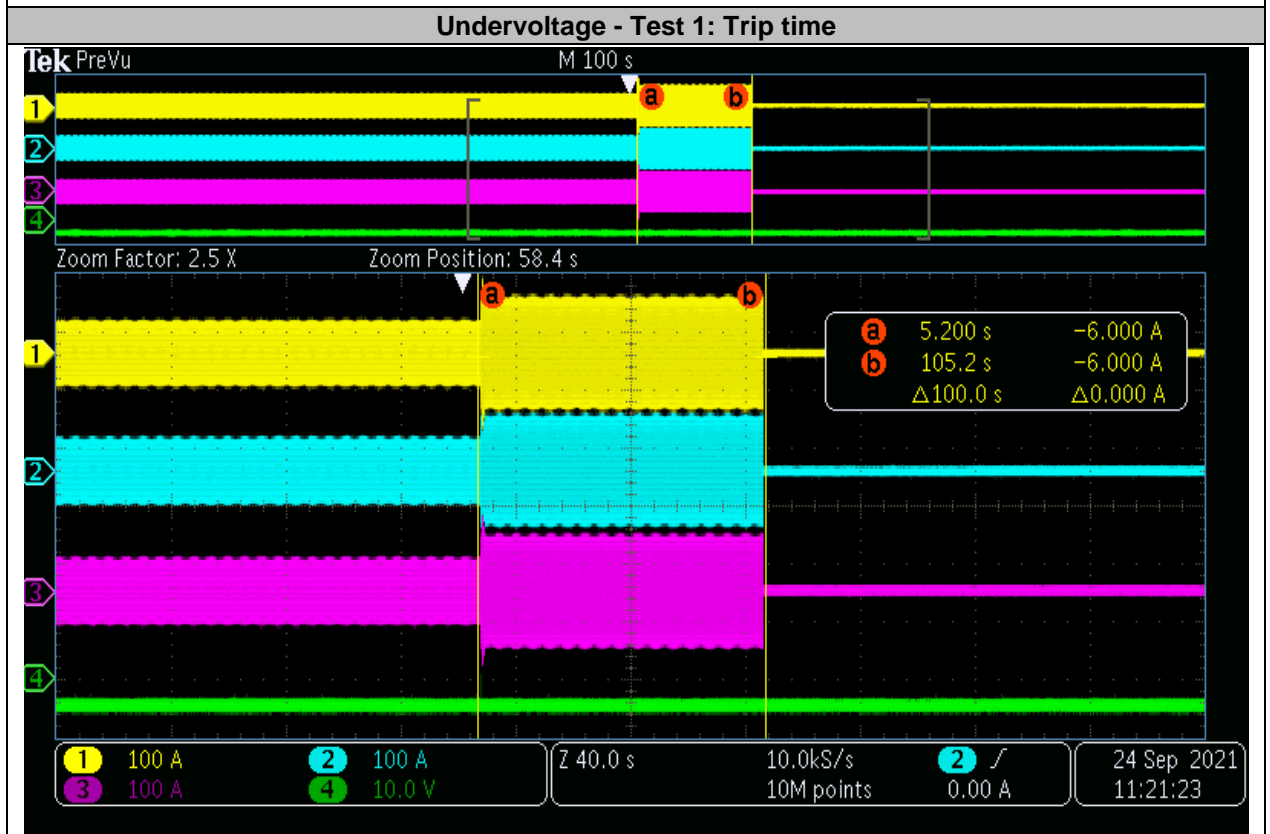
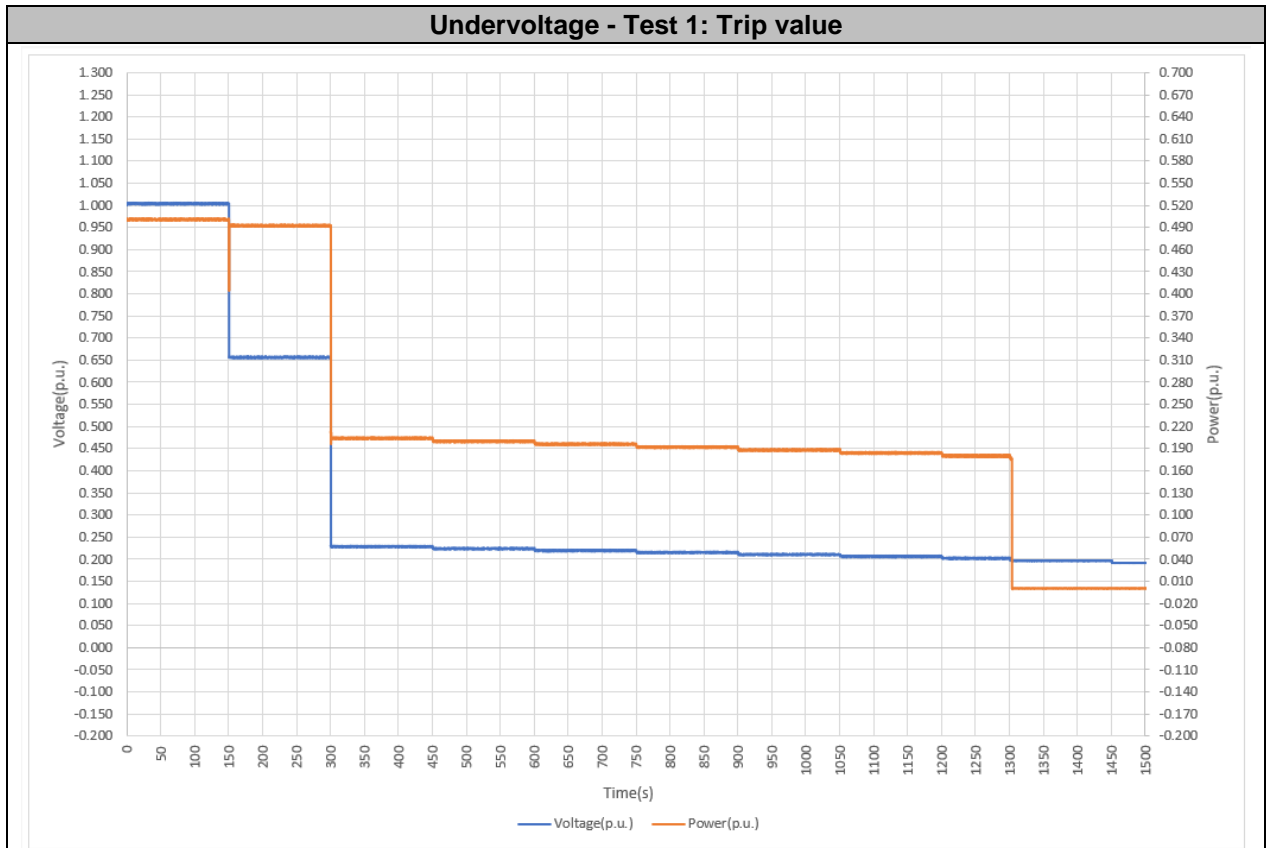

Under voltage - Test 2: Trip value

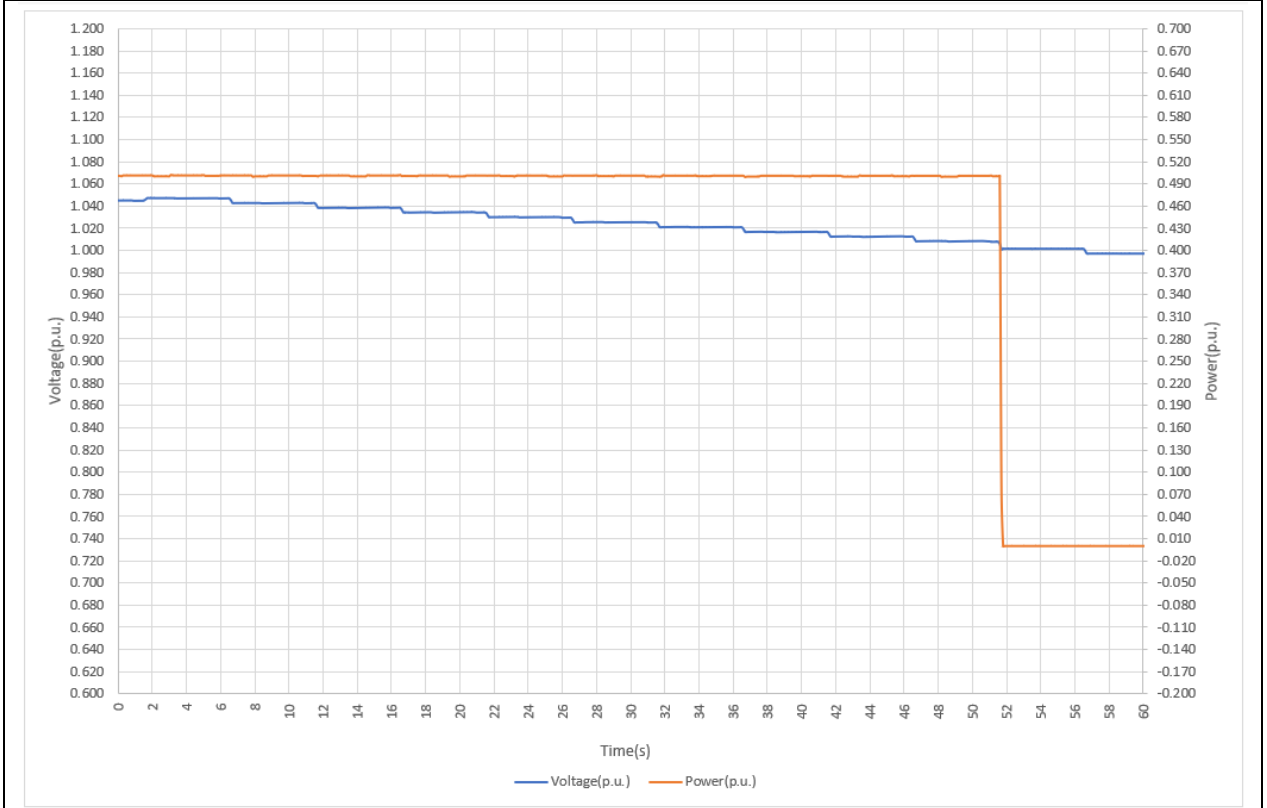

Under voltage - Test 2: Trip time

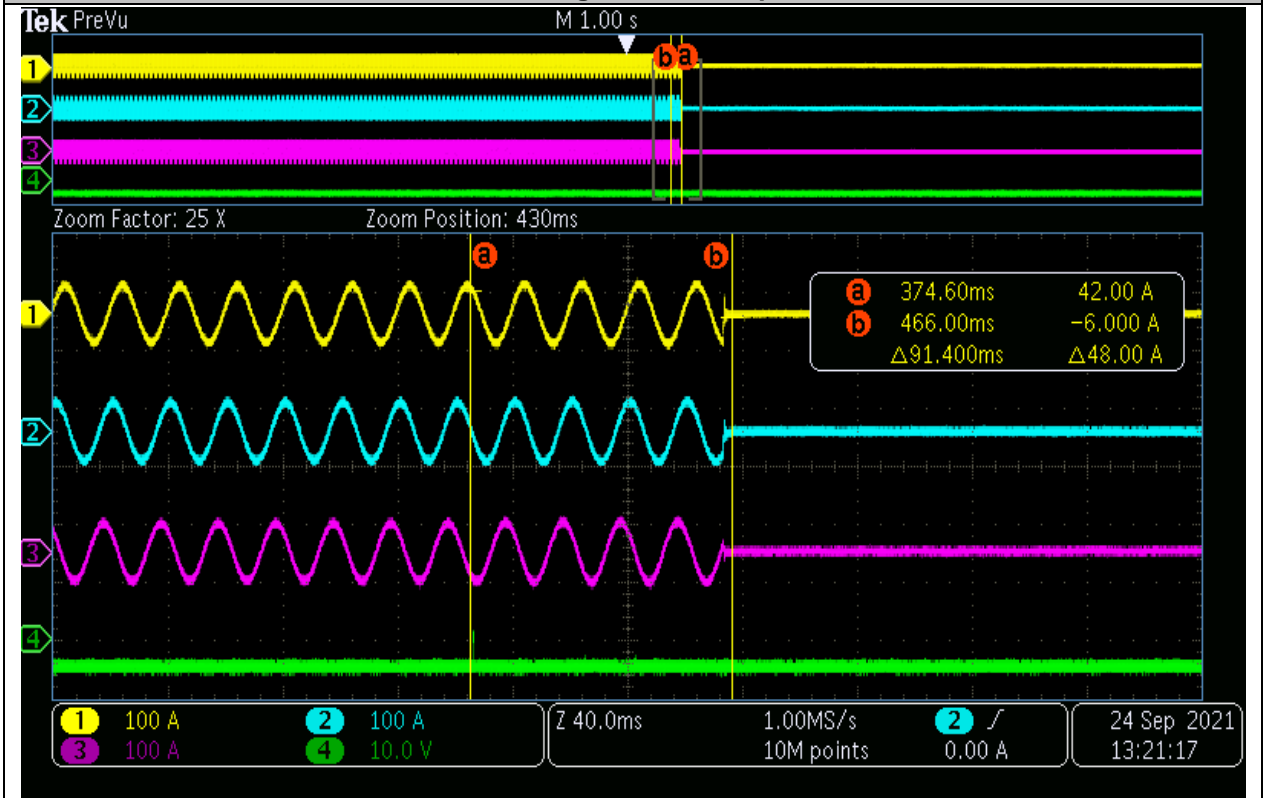

Undervoltage - Test 3: Trip value

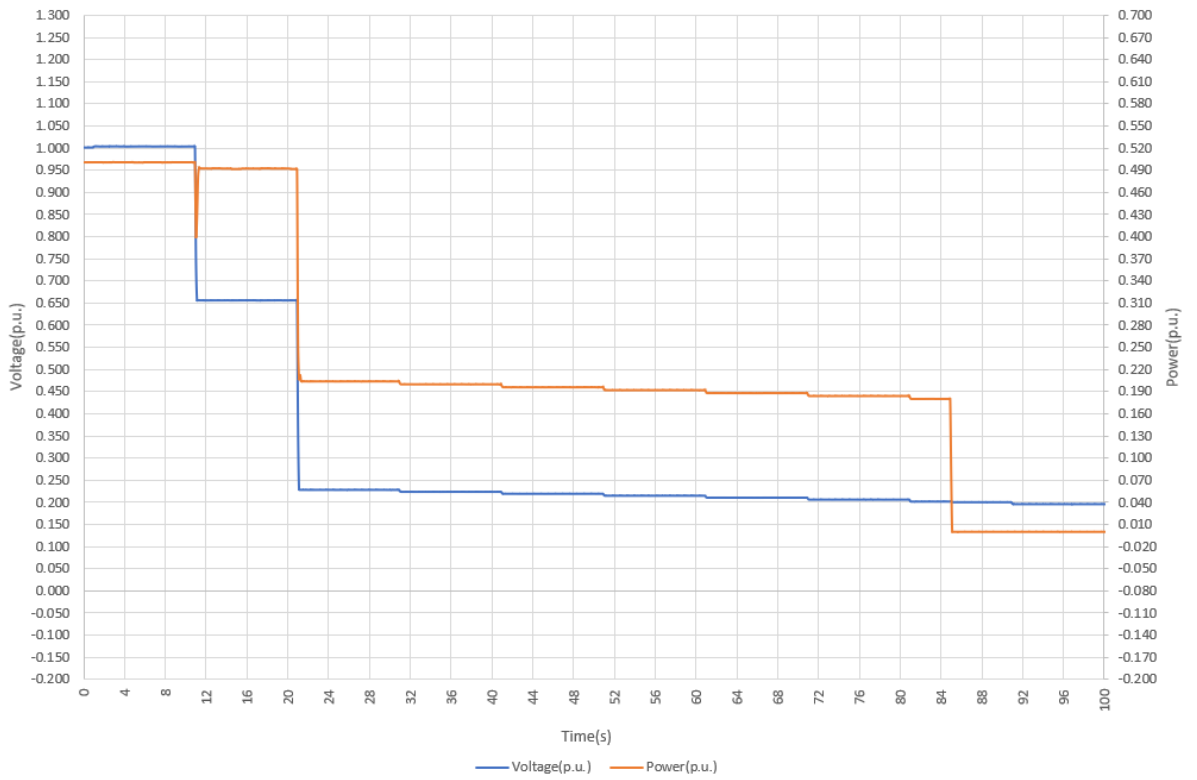

Undervoltage - Test 3: Trip time

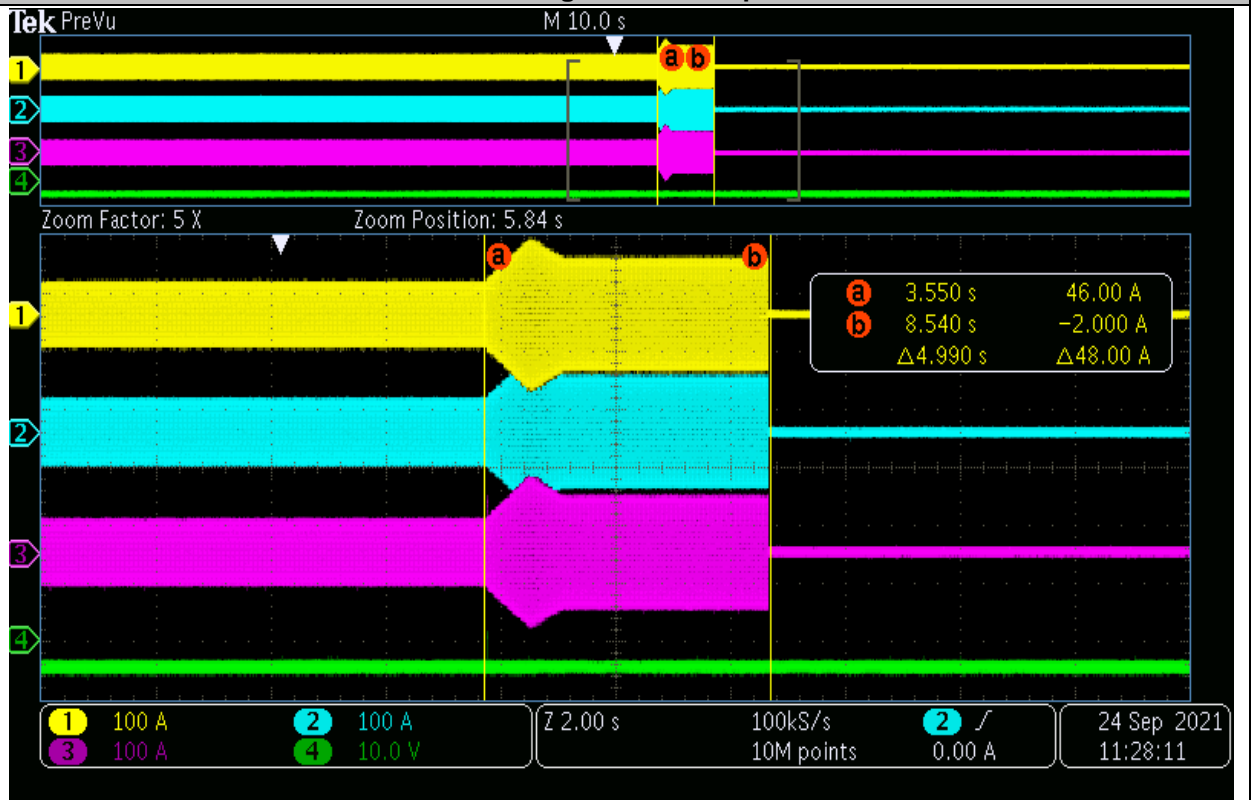

Undervoltage - Test 4: Trip value

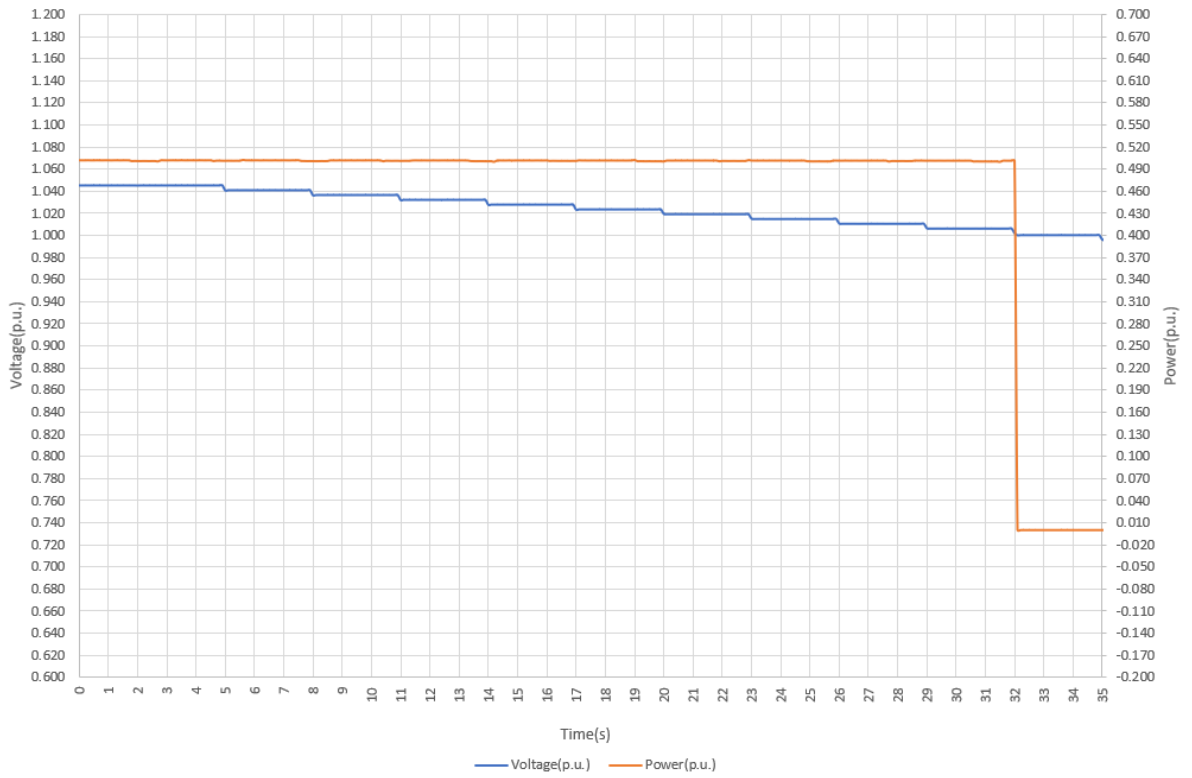

Undervoltage - Test 4: Trip time

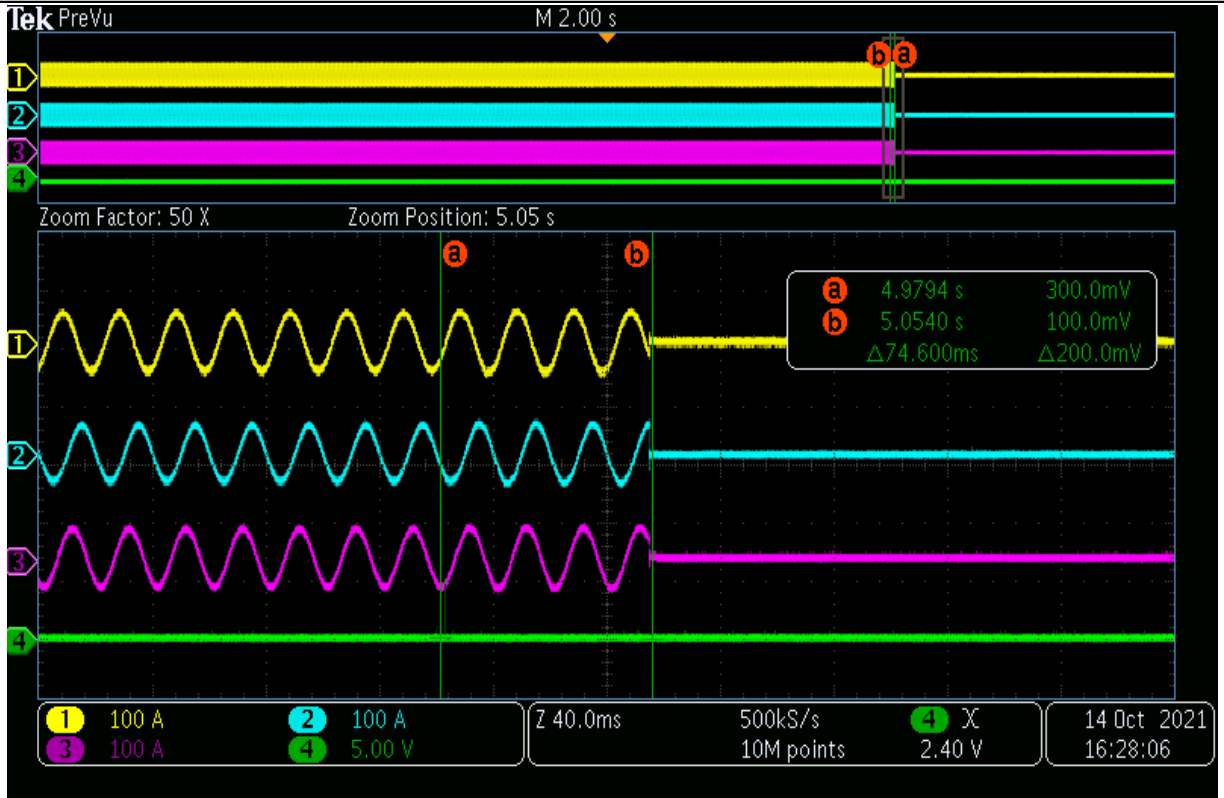

#### 4.6.1.2 Overvoltage protection

Overvoltage protection may be implemented with two completely independent protection thresholds, each one able to be activated or not. The standard adjustment ranges are as follows.

Overvoltage threshold stage 1 [59 >]:

- Threshold (1.0 – 1.2)  $U_n$  adjustable by steps of 0.01  $U_n$
- Operate time (0.1 – 100) s adjustable in steps of 0.1 s

Overvoltage threshold stage 2 [59 > >]:

- Threshold (1.0 – 1.30)  $U_n$  adjustable by steps of 0.01  $U_n$
- Operate time (0.1 – 5) s adjustable in steps of 0.05 s

The following definitions apply to the test to verify the clause:

Overvoltage	Test No.	Voltage setting (p.u.)	Voltage meas. (p.u.)	Voltage deviation (p.u.)	Trip time setting (s)	Trip time meas. (s)	Trip time deviation (s)
<b>Stage 1</b> [59 >]:	1	1.000	1.004	+0.004	100.000	100.000	0.000
	2	1.200	1.201	+0.001	0.100	0.081	-0.019
<b>Stage 2</b> [59 > >]:	3	1.000	1.004	+0.004	5.000	4.964	-0.036
	4	1.300	1.301	+0.001	0.100	0.093	-0.007

Test results are represented at diagrams below.

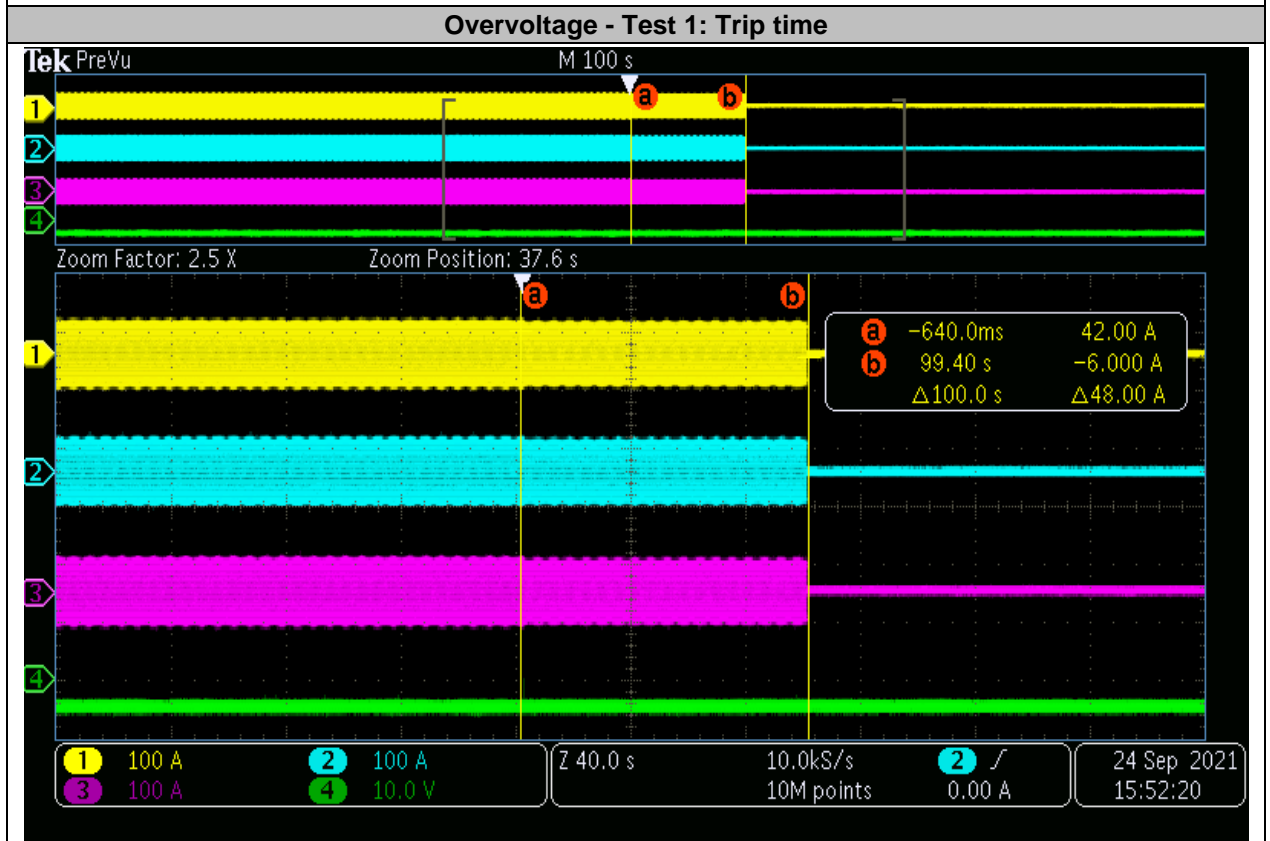
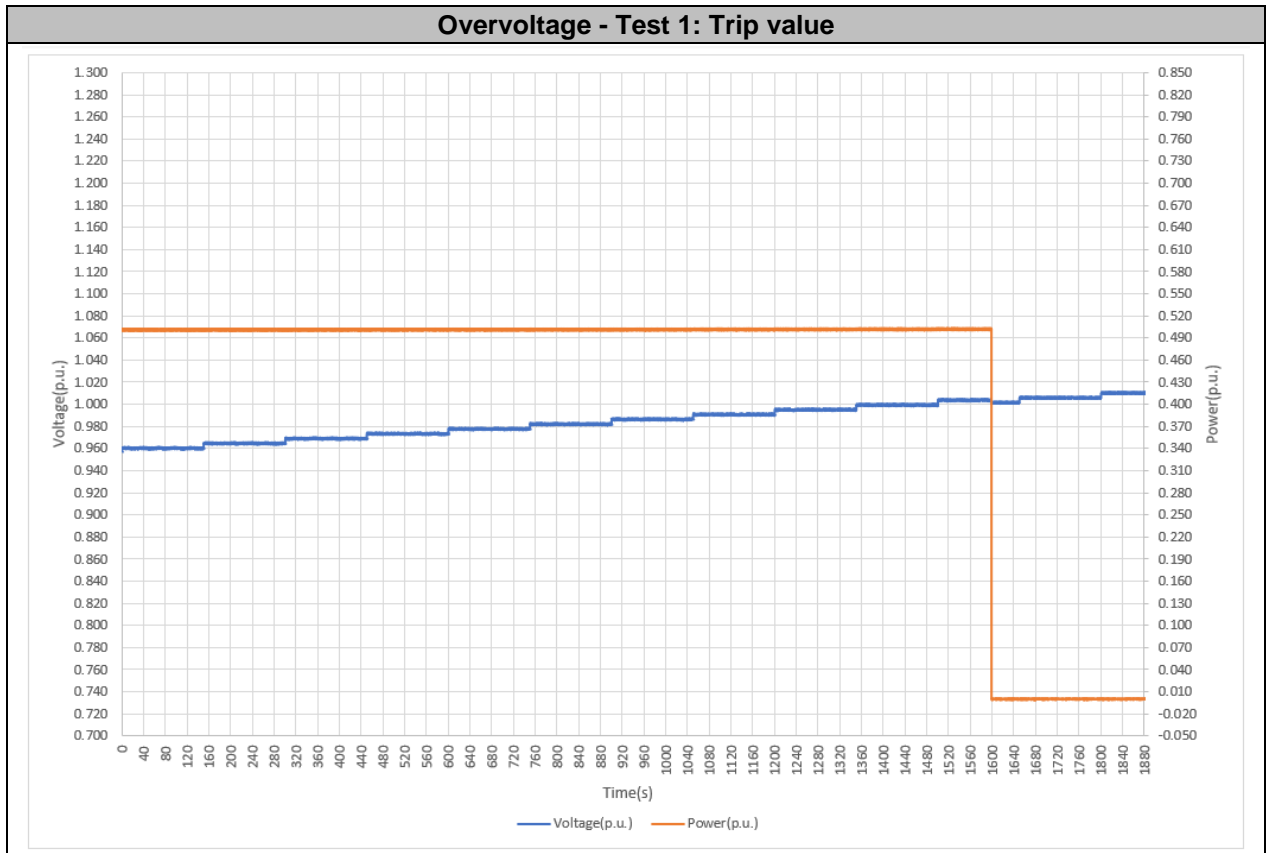



Overvoltage - Test 2: Trip value

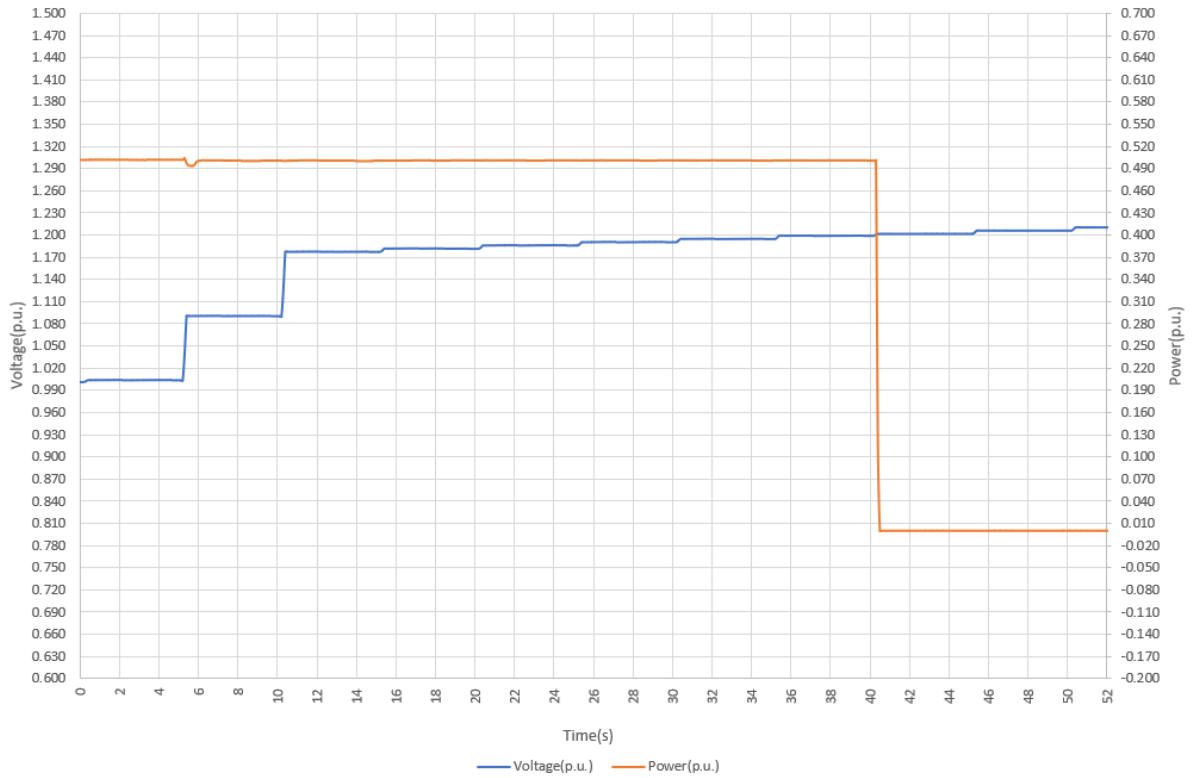

Overvoltage - Test 2: Trip time

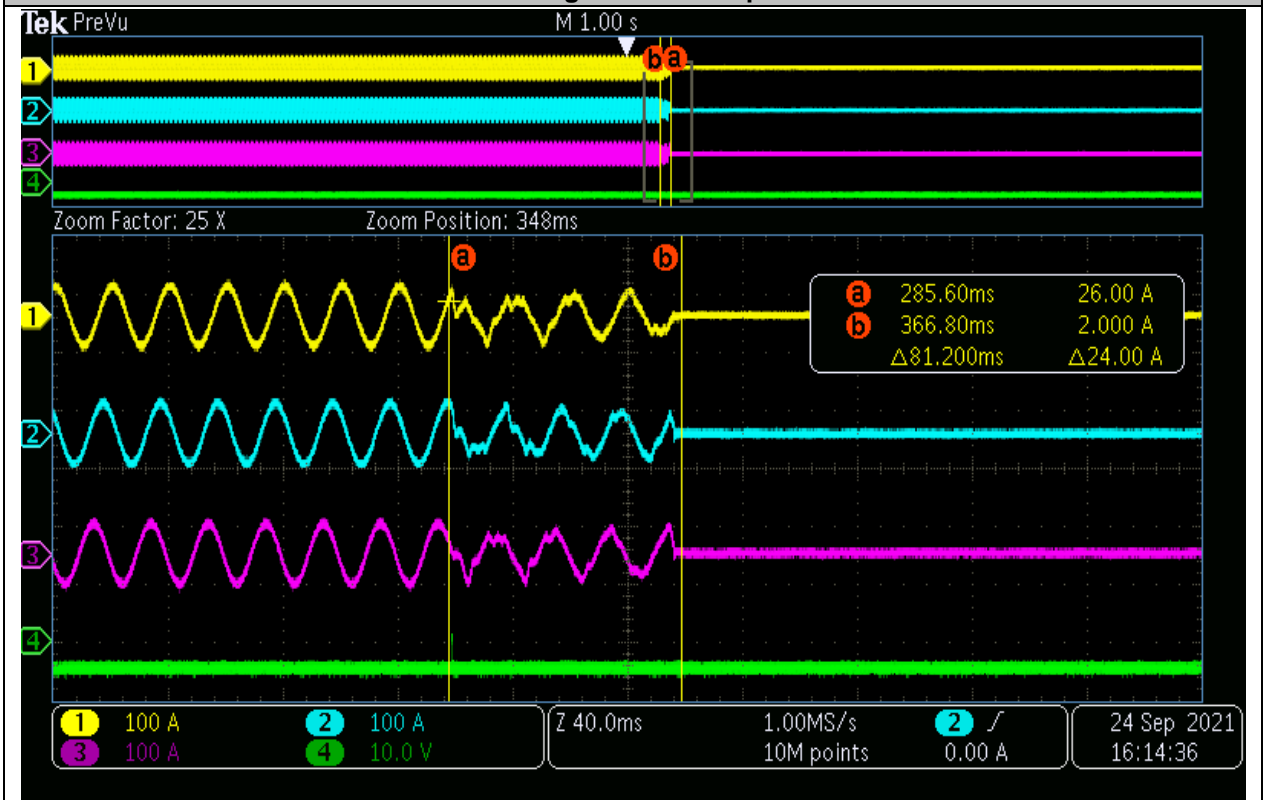

Overvoltage - Test 3: Trip value

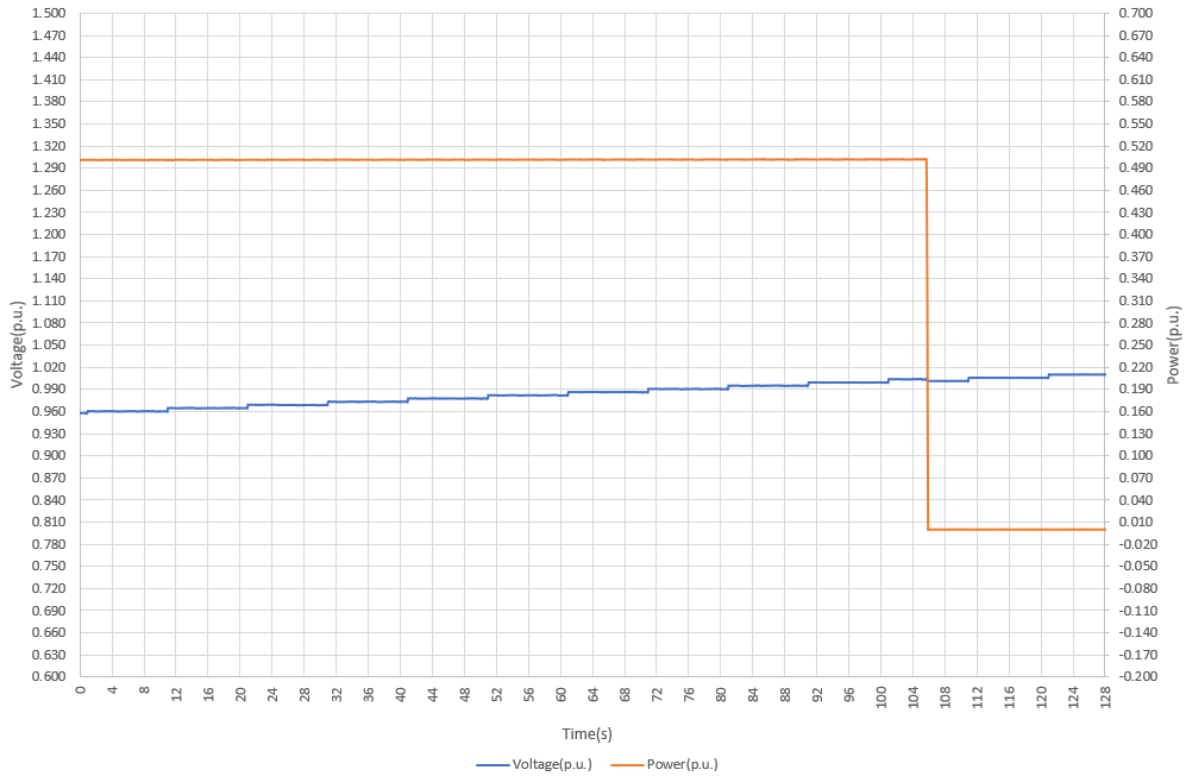

Overvoltage - Test 3: Trip time

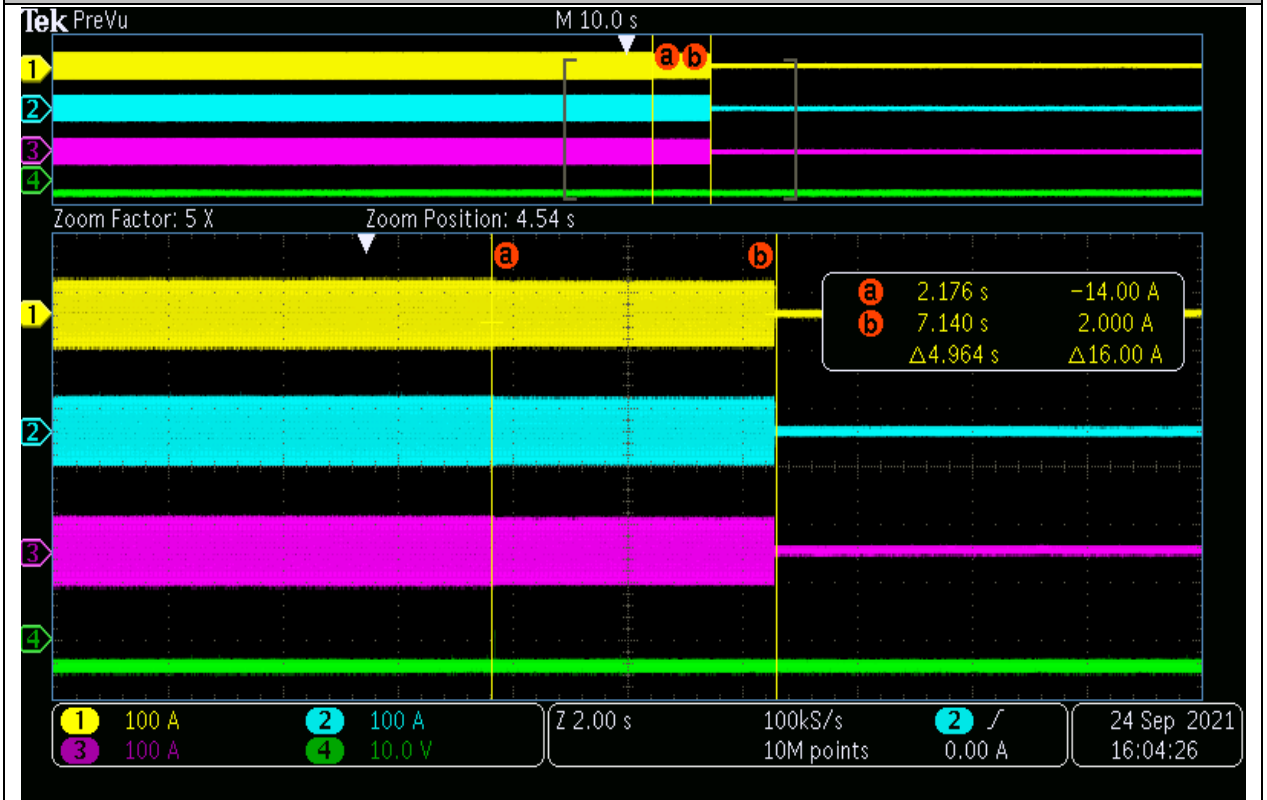

Overvoltage - Test 4: Trip value

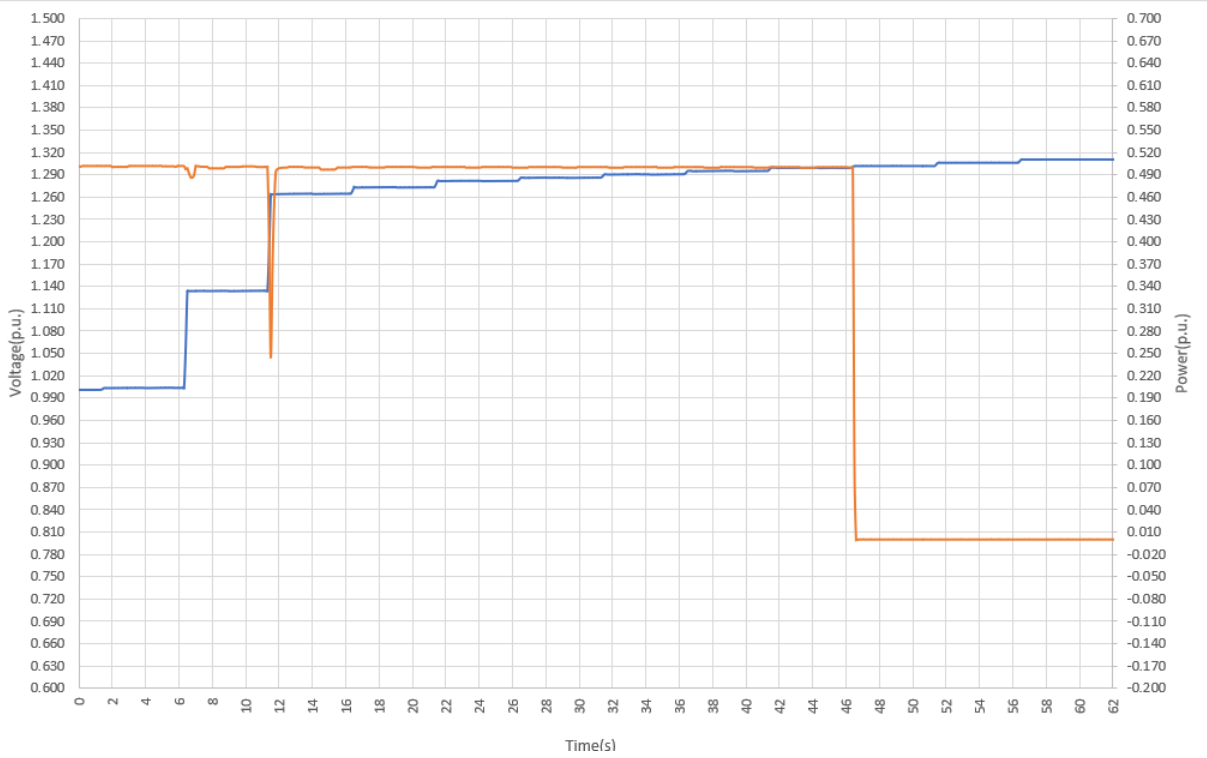

Overvoltage - Test 4: Trip time

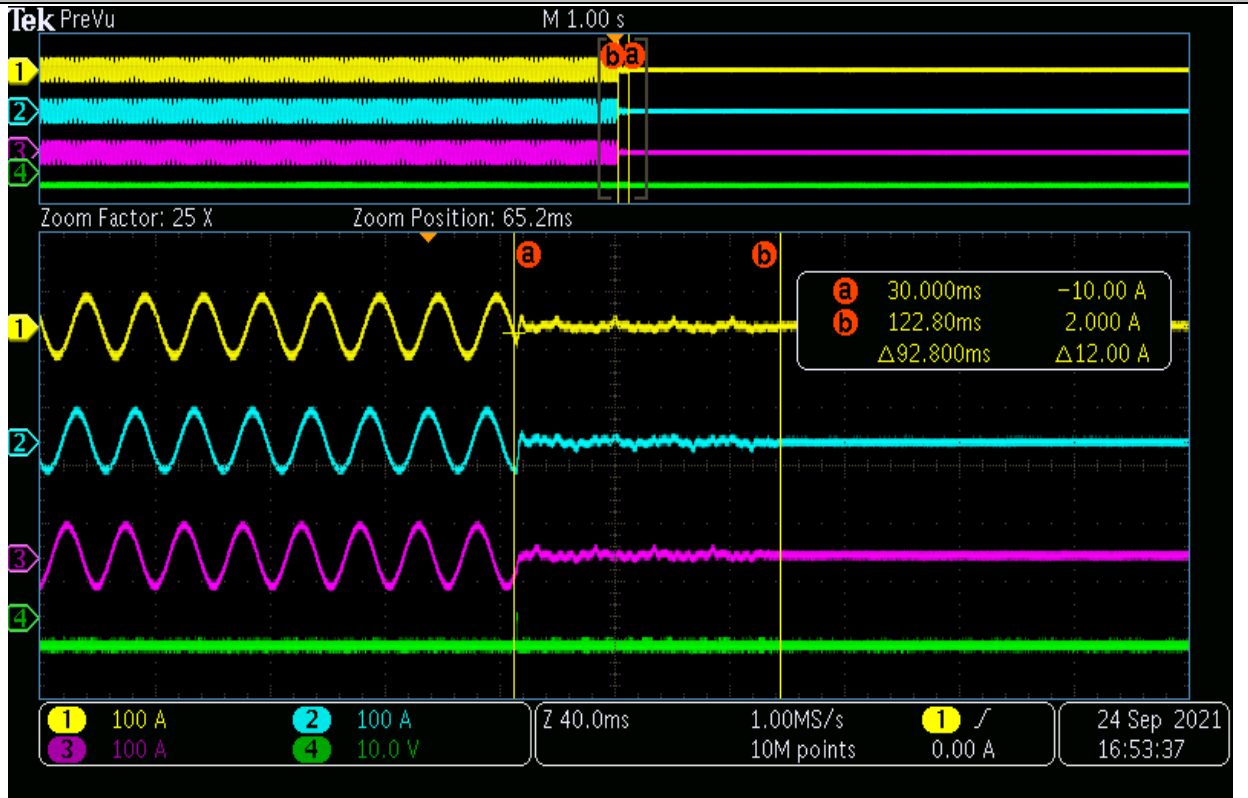

#### 4.6.1.3 Overvoltage 10 min mean protection

The function shall be based on the calculation of the square root of the arithmetic mean of the squared input values over 10 min. The calculation of a new 10 min value at least every 3 s is sufficient, which is then to be compared with the threshold value.

- Threshold (1.0 – 1.15)  $U_n$  adjustable by steps of 0.01  $U_n$
- Start time  $\leq 3$ s not adjustable
- Time delay setting = 0 ms

The following definitions apply to the test to verify the clause:

Test No.	Voltage setting (p.u.)	Voltage meas. (p.u.)	Voltage deviation (p.u.)	Trip time meas. (s)	Trip time limited
1	1.000	1.000	0.000	2.8	$\leq 3.0$ s
2	1.150	1.150	0.000	2.2	$\leq 3.0$ s

Note: The trip voltage accuracy tolerance is  $\pm 0.01 U_n$

Test results are represented at diagrams below.

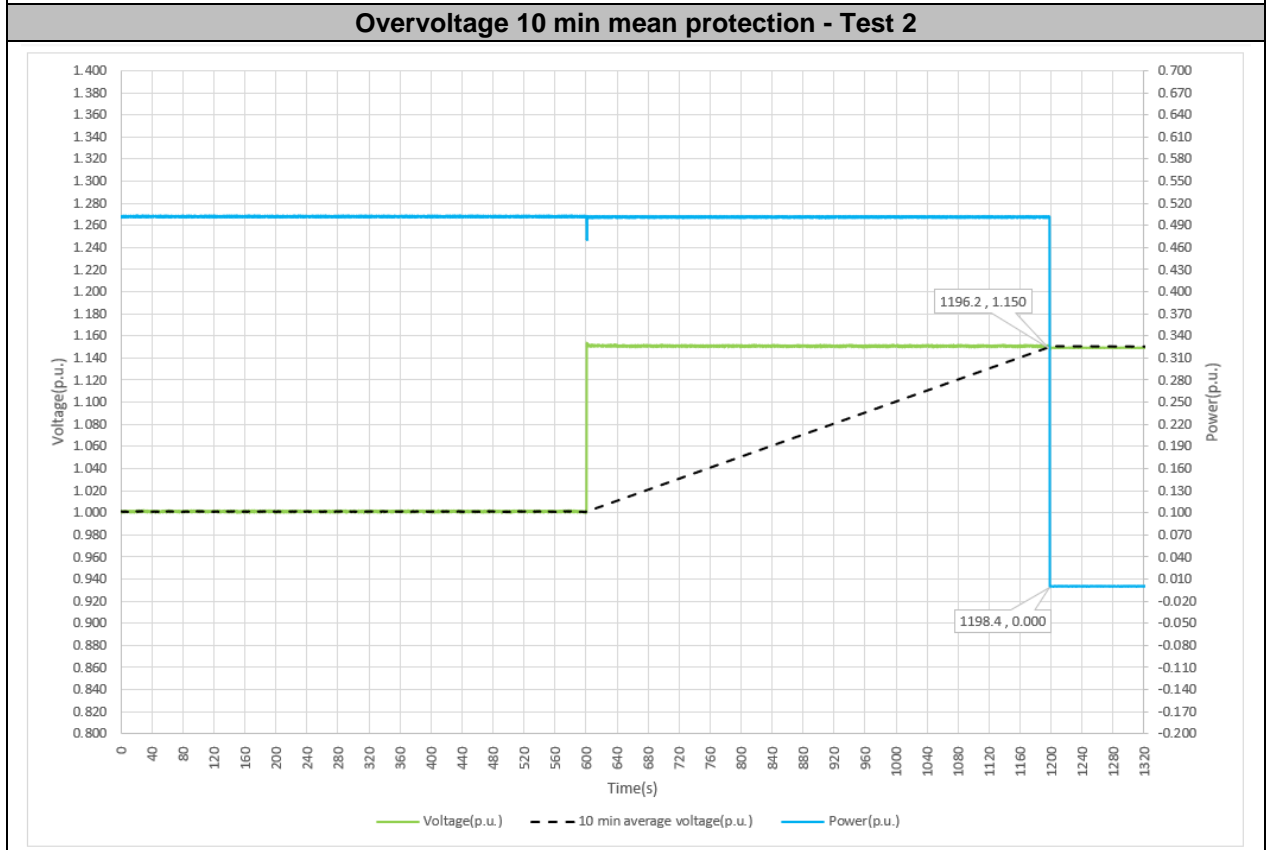
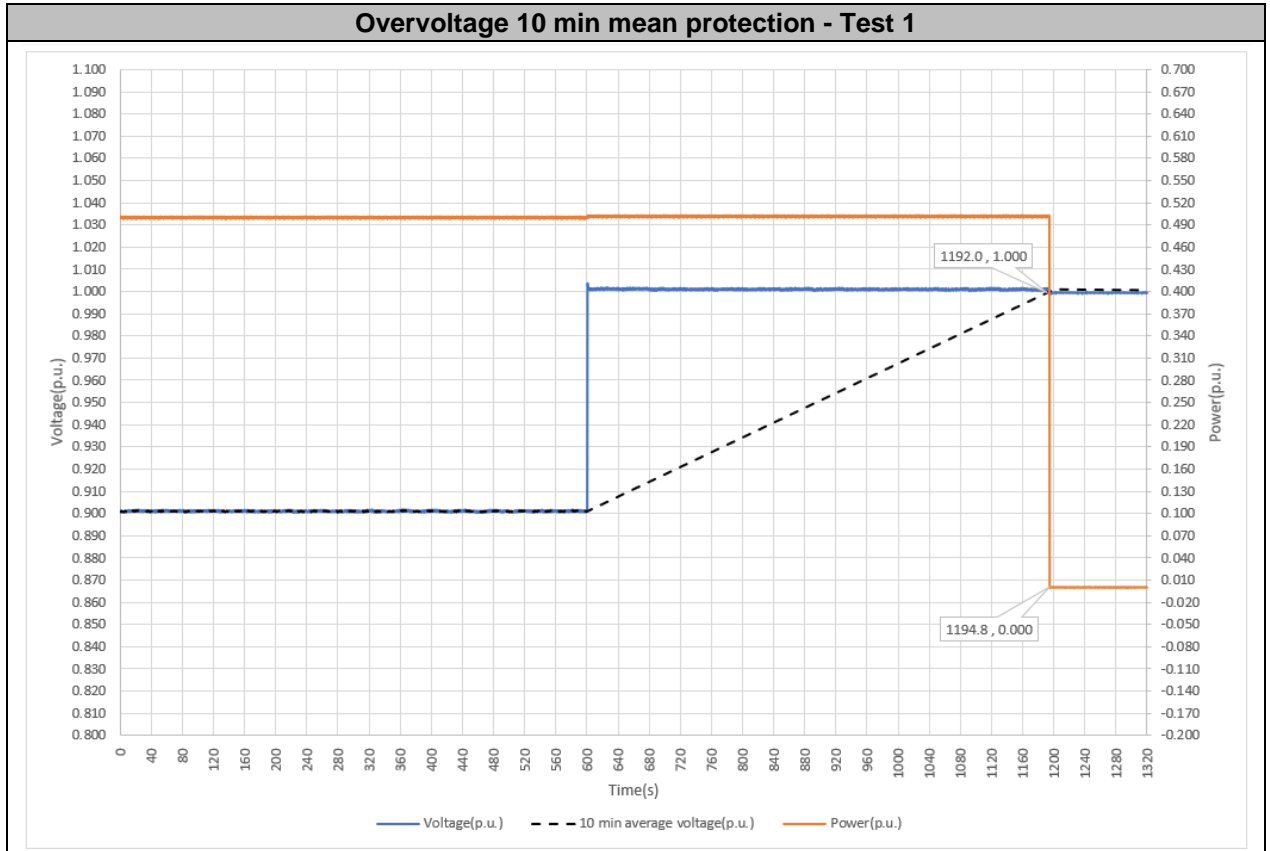

#### 4.6.1.4 Underfrequency protection

Underfrequency protection may be implemented with two completely independent protection thresholds, each one able to be activated or not. The standard adjustment ranges are as follows.

Underfrequency threshold stage 1 [81 <]:

- Threshold (47.0 – 50.0) Hz adjustment by steps of 0.1 Hz
- Operate time (0.1 – 100) s adjustable in steps of 0.1 s

Underfrequency threshold stage 2 [81 <<]:

- Threshold (47.0 – 50.0) Hz adjustment by steps of 0.1 Hz
- Operate time (0.1 – 5) s adjustable in steps of 0.05 s

In order to use narrow frequency thresholds for islanding detection (see 4.9.3.3) it may be required to have the ability to activate and deactivate a stage by an external signal.

The frequency protection shall function correctly in the input voltage range between 20 % Un and 120 % Un and shall be inhibited for input voltages of less than 20 % Un.

Under 0.2 Un the frequency protection is inhibited. Disconnection may only happen based on undervoltage protection.

The following definitions apply to the test to verify the clause:

Under frequency	Test No.	Frequency setting (Hz)	Frequency meas. (Hz)	Frequency deviation (Hz)	Trip time setting (s)	Trip time meas. (s)	Trip time deviation (s)
Stage 1 [81 <]	1	47.00	46.98	-0.02	100.000	99.980	-0.020
	2	50.00	50.00	0.00	0.100	0.087	-0.013
Stage 2 [81 <<]	3	47.00	46.99	-0.01	5.000	4.612	-0.388
	4	50.00	50.00	0.00	0.100	0.085	-0.015

Voltage protection threshold setting (p.u.)	Test No.	Frequency setting (Hz)	Voltage setting (p.u.)	Trip value meas. (Hz)	Trip time setting (s)	Trip time meas. (s)	Trip time deviation (s)
0.18 & 1.22	5	47.00	0.21	46.95	5.000	4.672	-0.328
	6	47.00	1.19	46.98	5.000	4.970	-0.030
	7	47.00	0.19	46.98	Not protected	--	--
		47.00	0.17	46.98	5.000	4.970	-0.030
	8	47.00	1.21	46.98	Not protected	--	--
		47.00	1.23	46.98	5.000	4.652	-0.348

Note: Tests 7 and 8 are comprised by two different steps, the first was to verify the no trip value, and the second step was to verify the trip time.

Test results are represented at diagrams below.

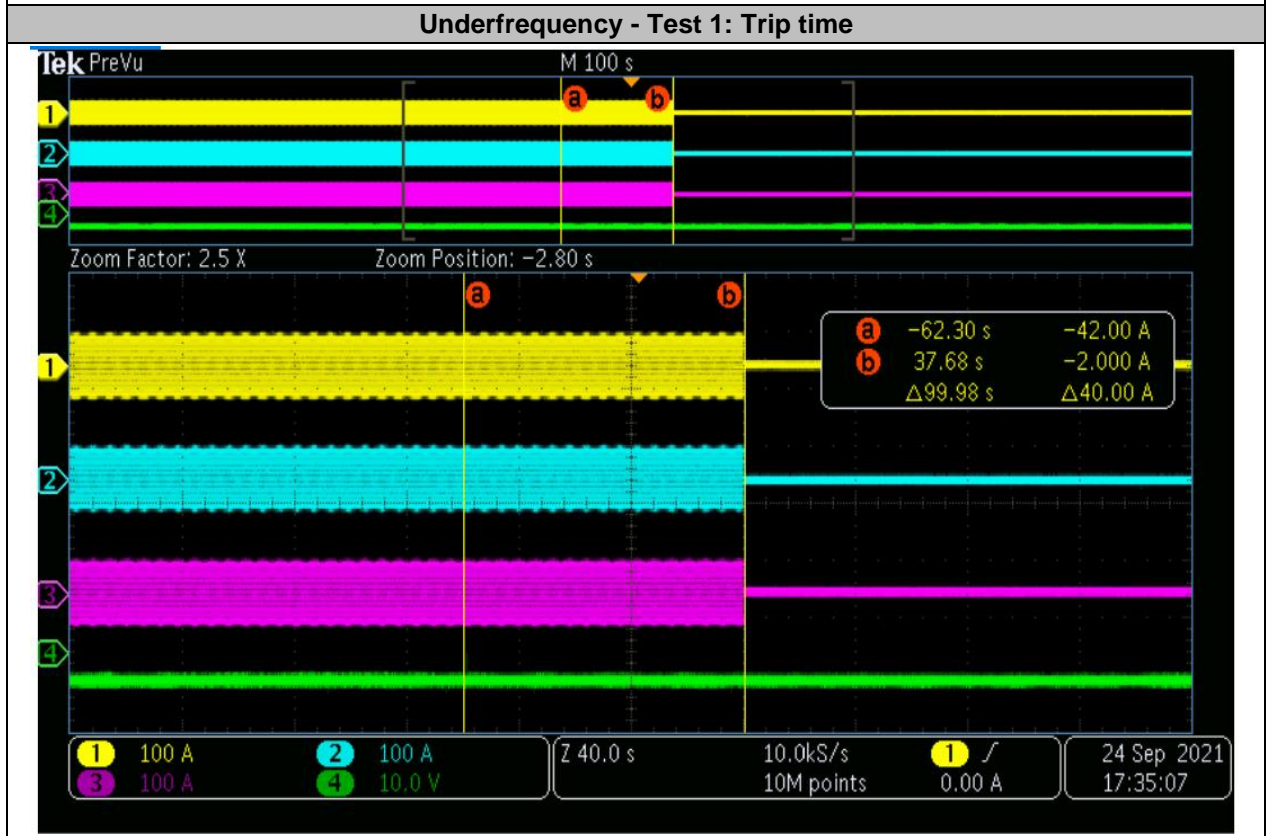
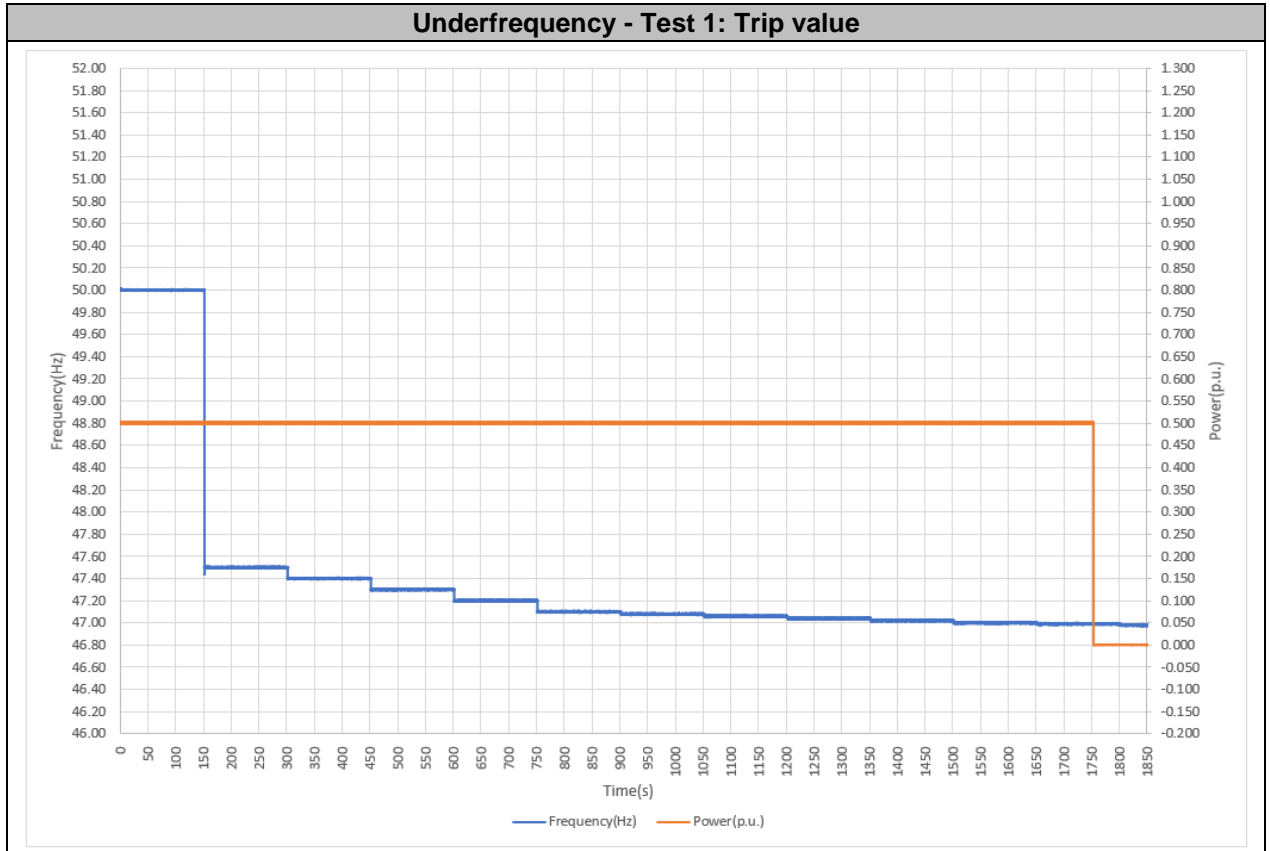

Underfrequency - Test 2: Trip value

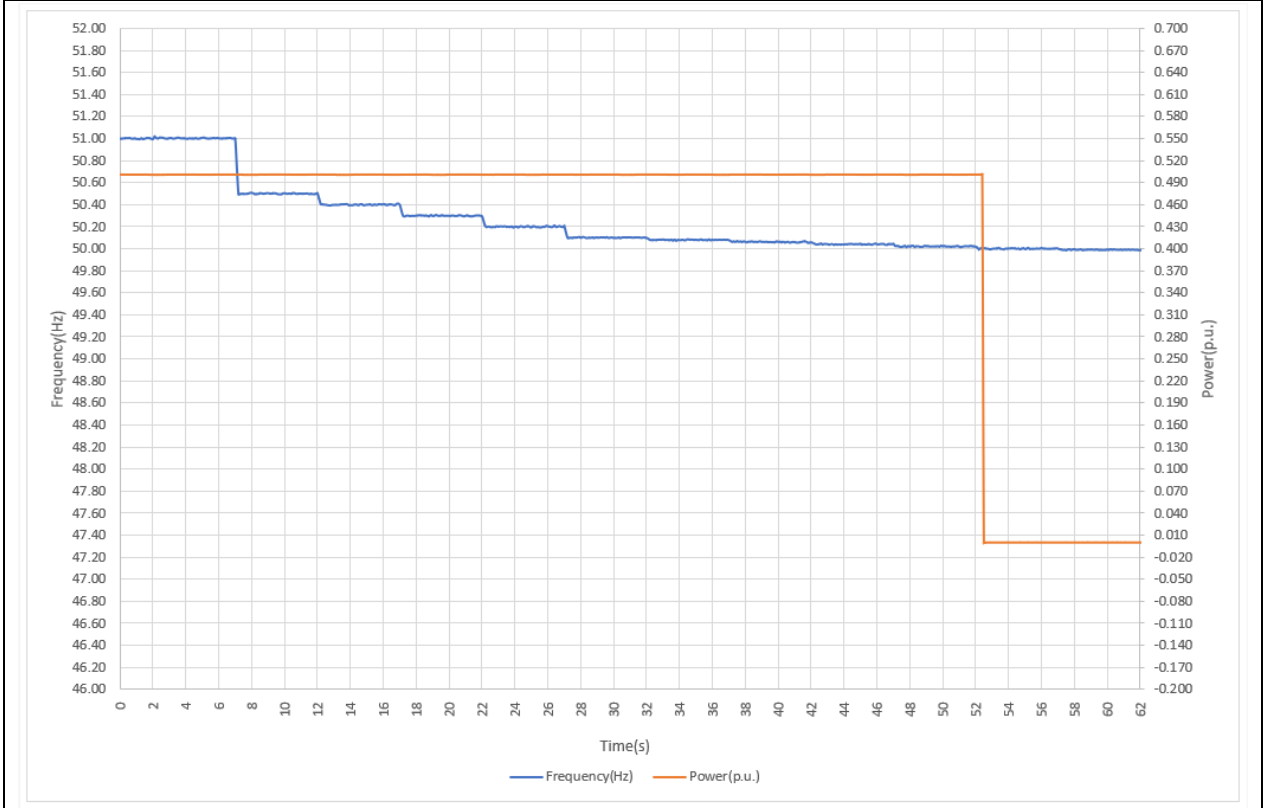

Underfrequency - Test 2: Trip time

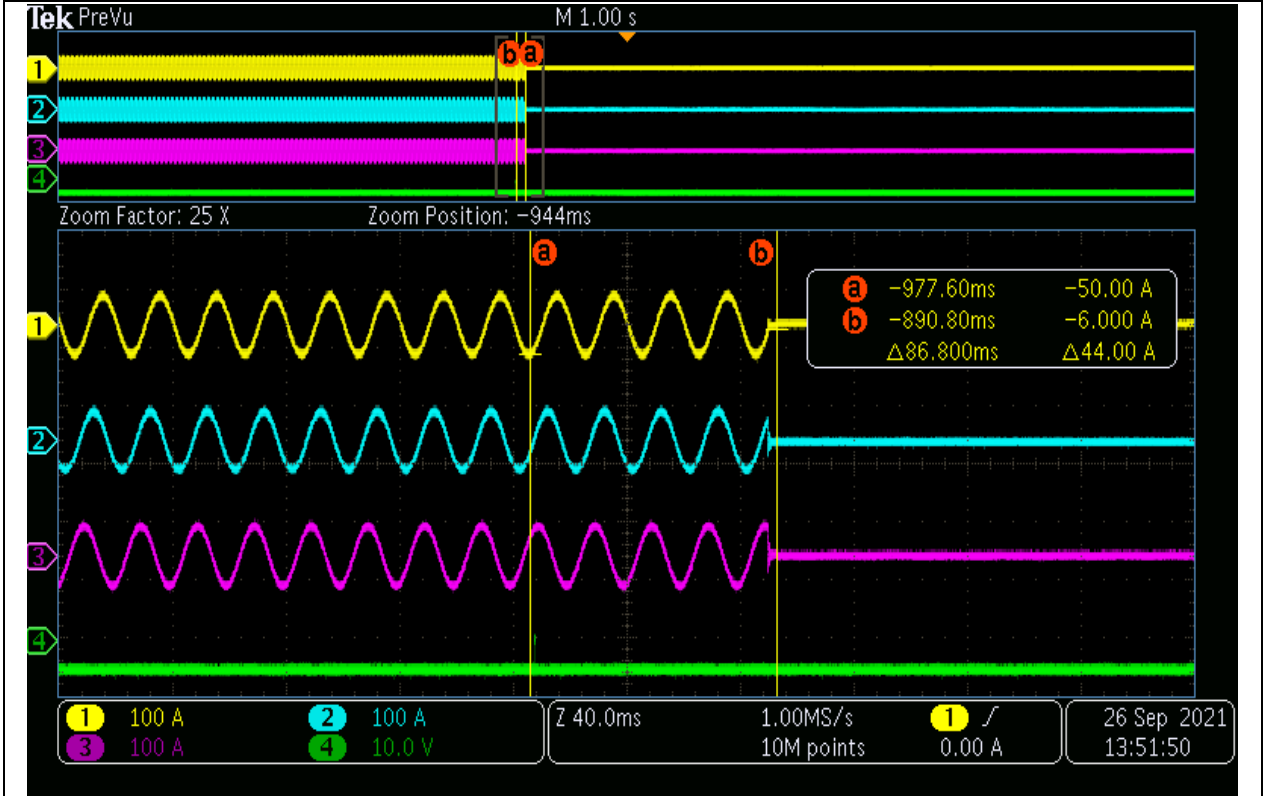



Underfrequency - Test 3: Trip value

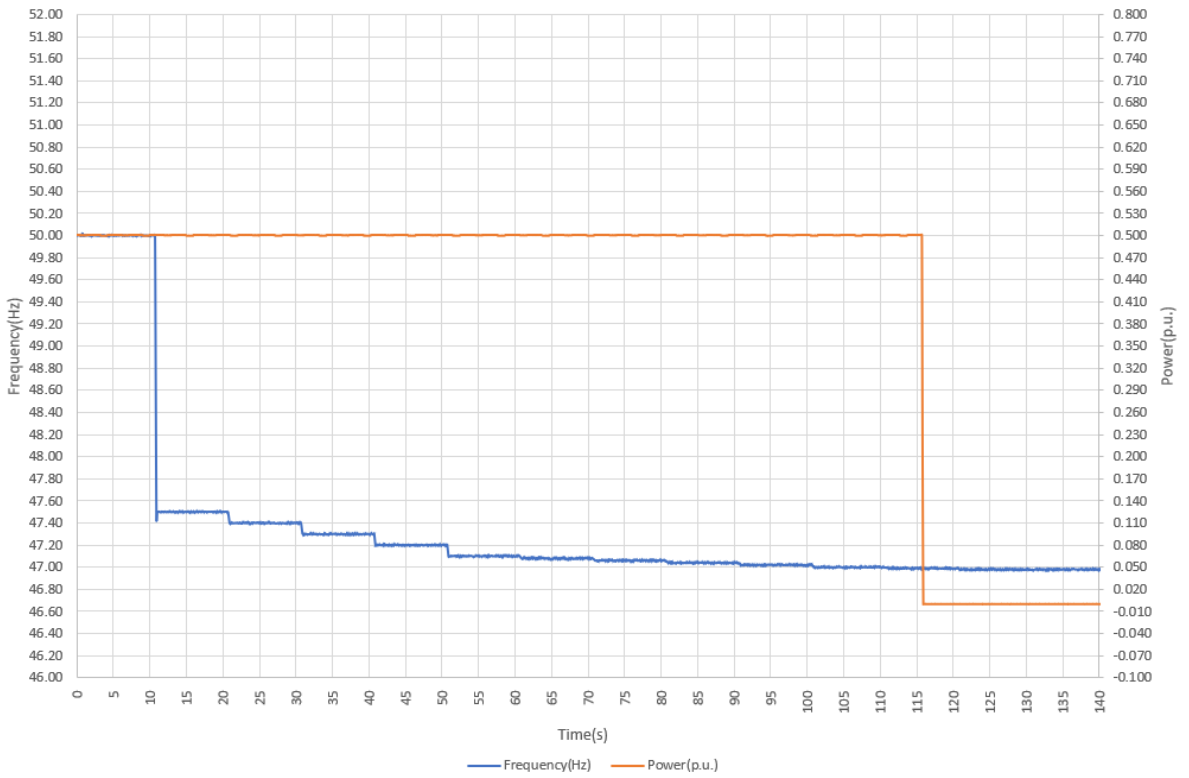

Underfrequency - Test 3: Trip time

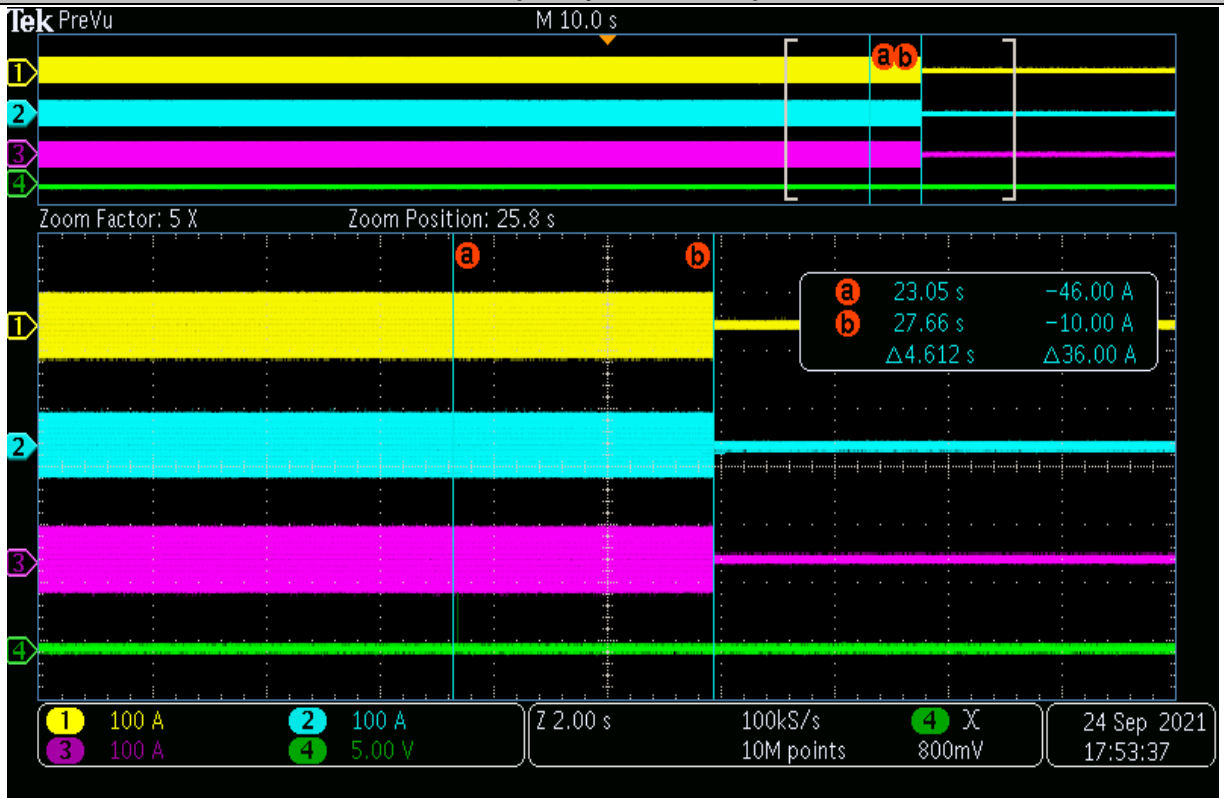

Underfrequency - Test 4: Trip value

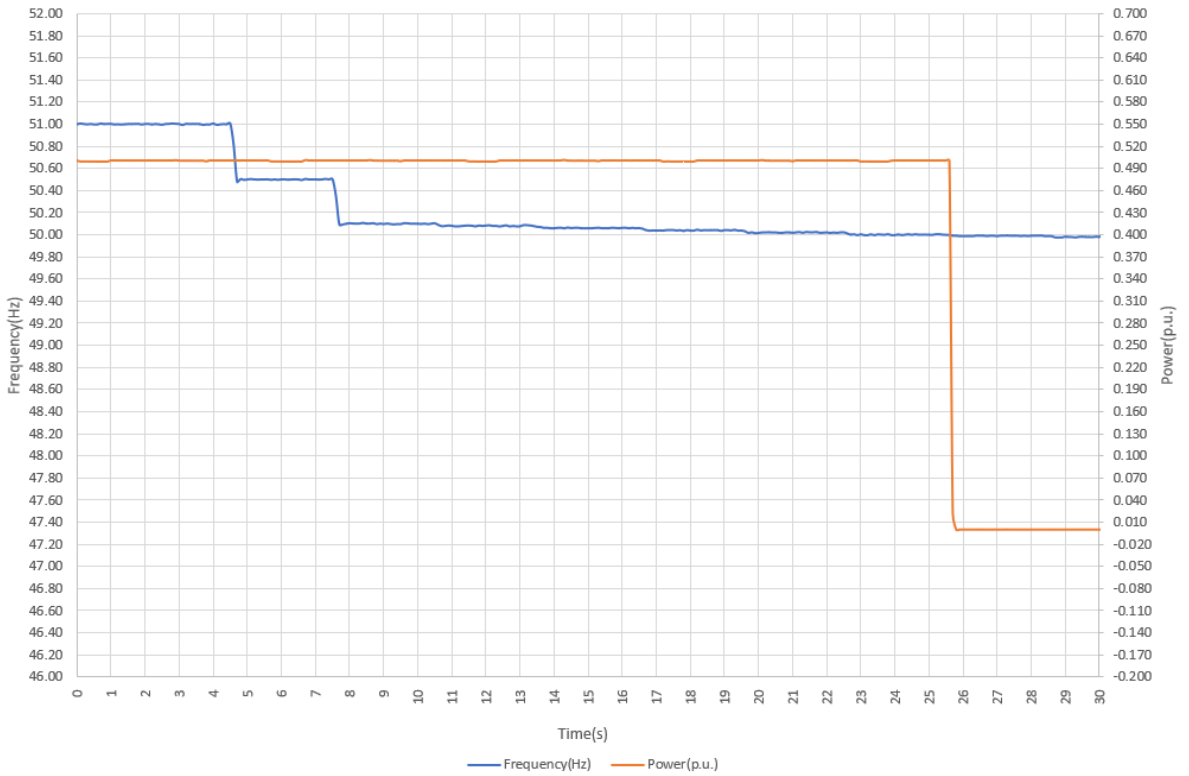

Underfrequency - Test 4: Trip time

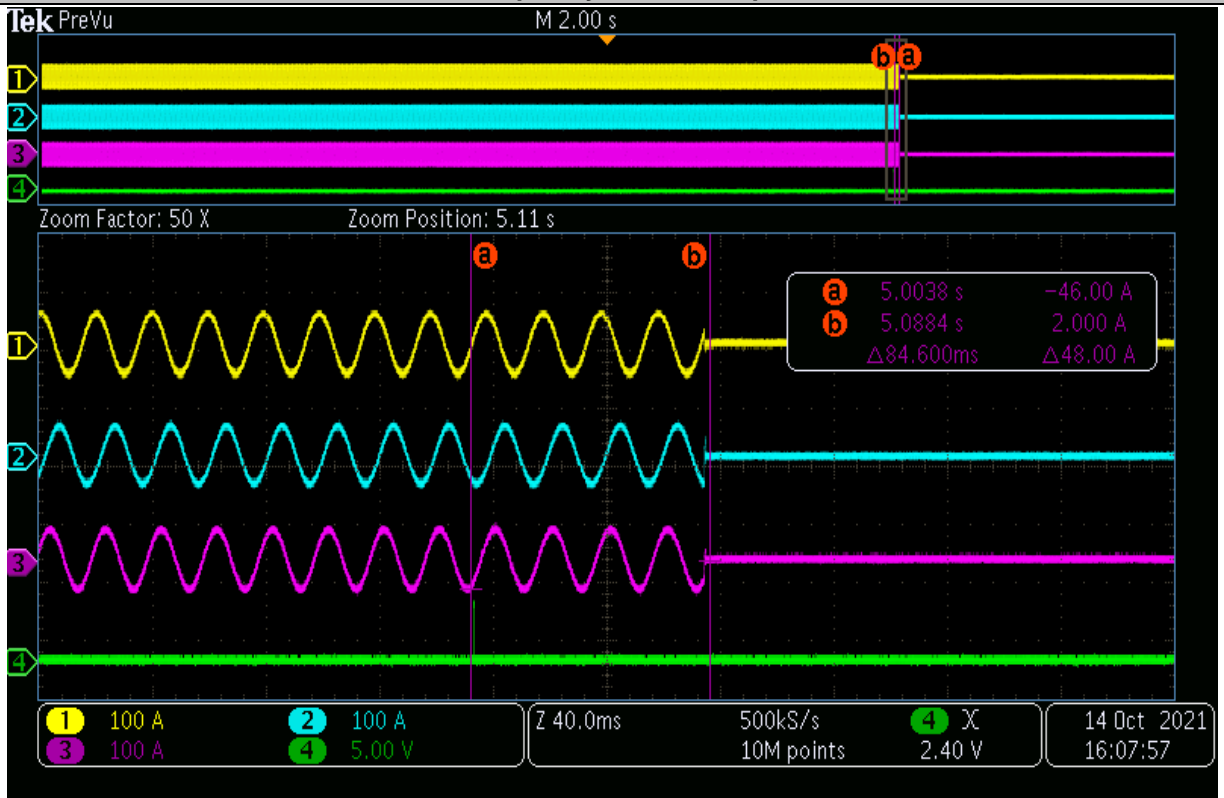

Underfrequency - Test 5: Trip value

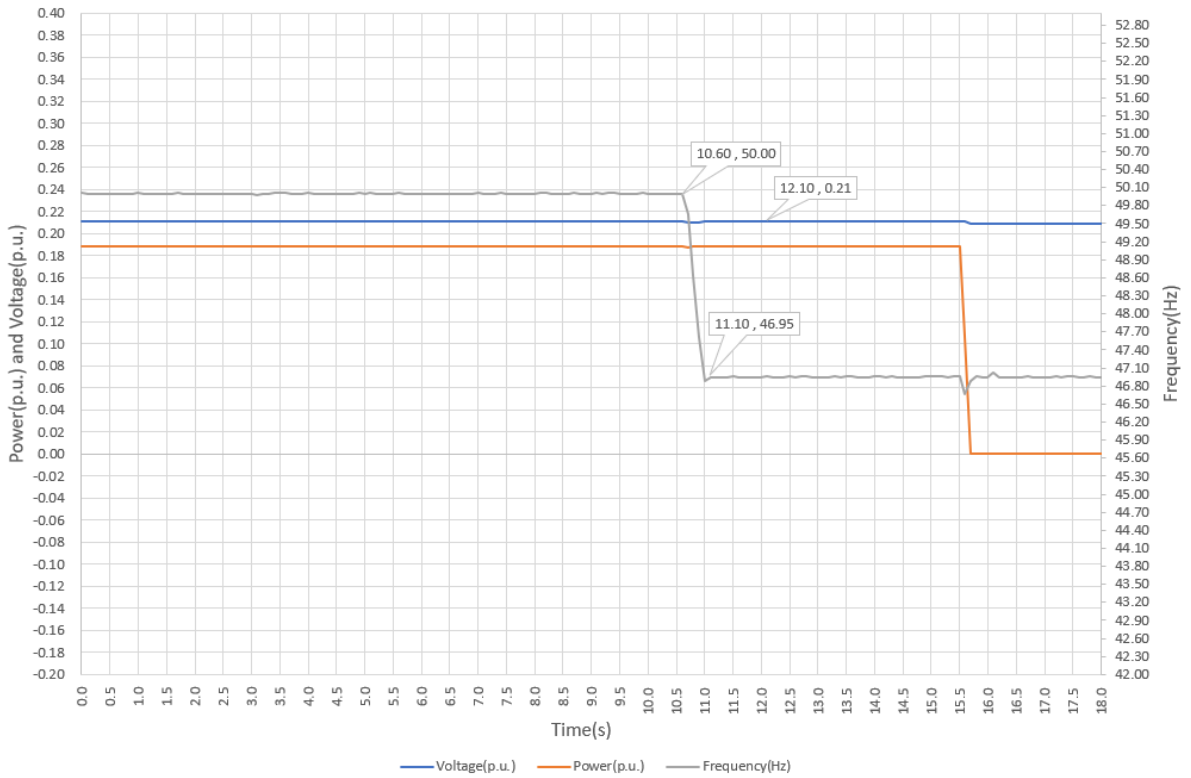

Underfrequency - Test 5: Trip time

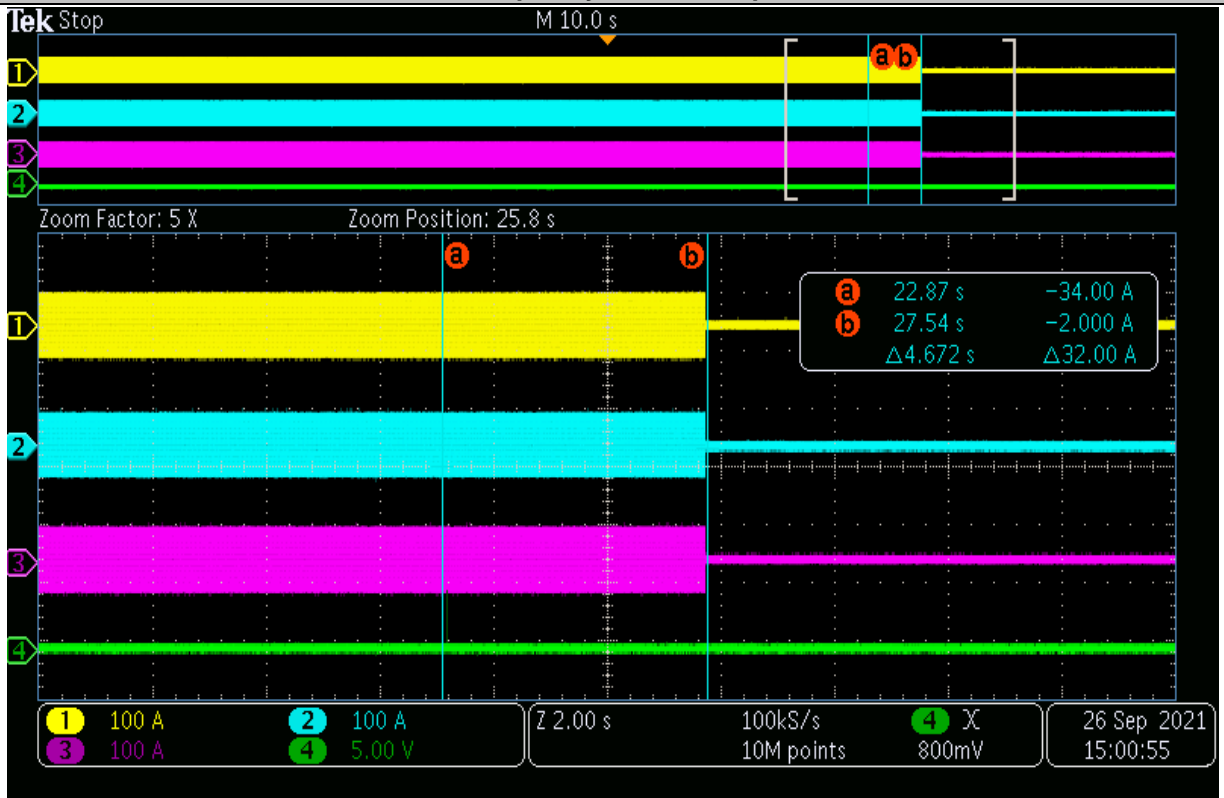

Underfrequency - Test 6: Trip value

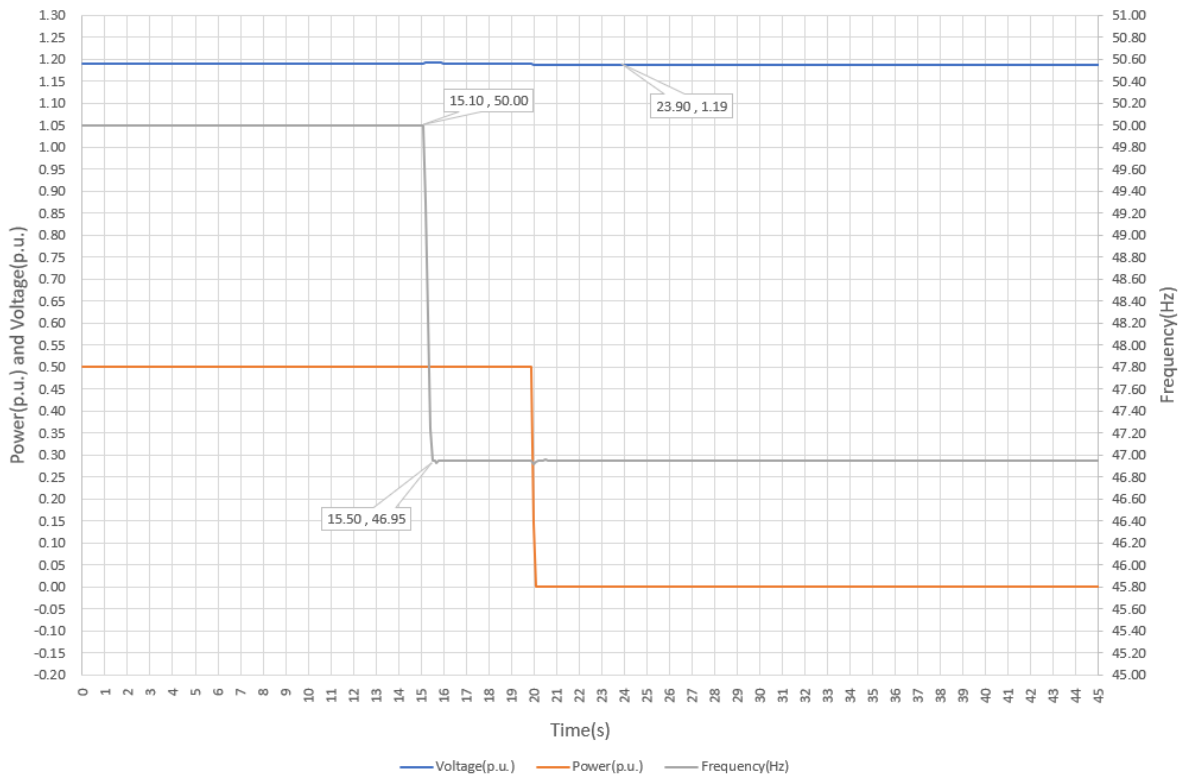

Underfrequency - Test 6: Trip time

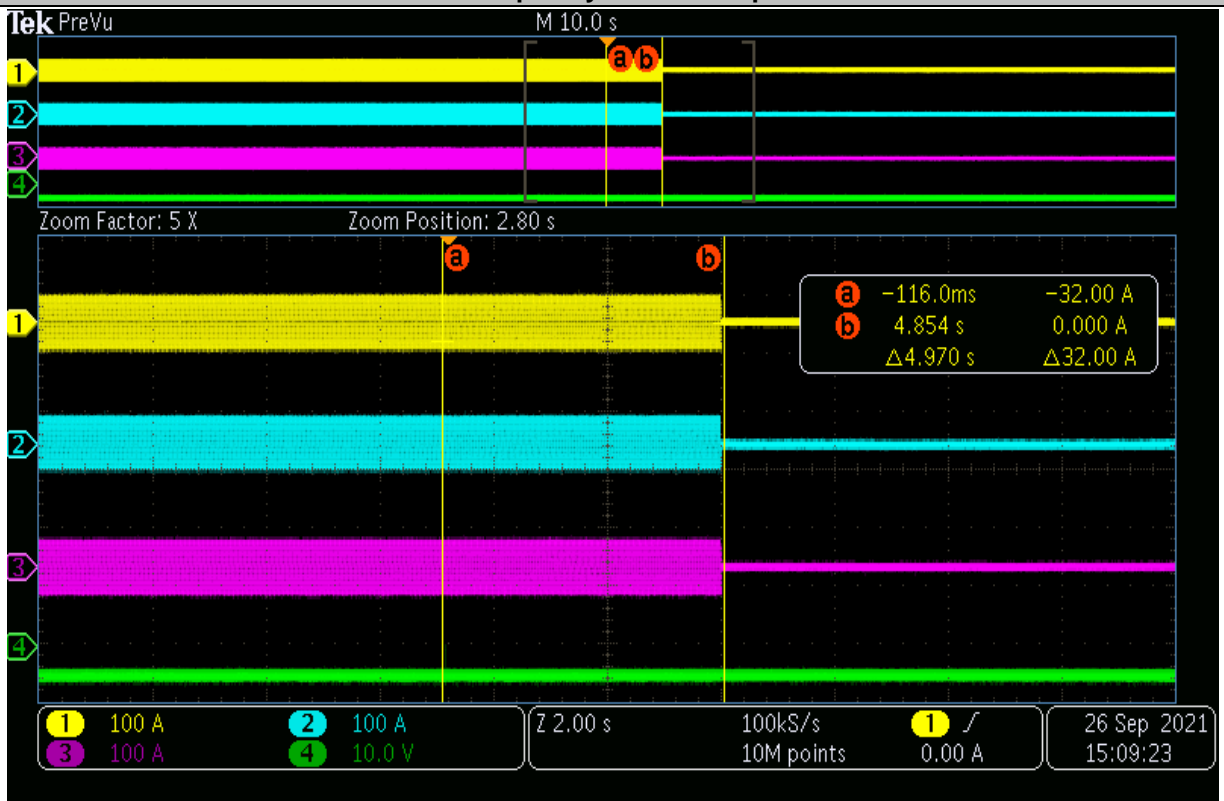

Underfrequency - Test 7: Trip value

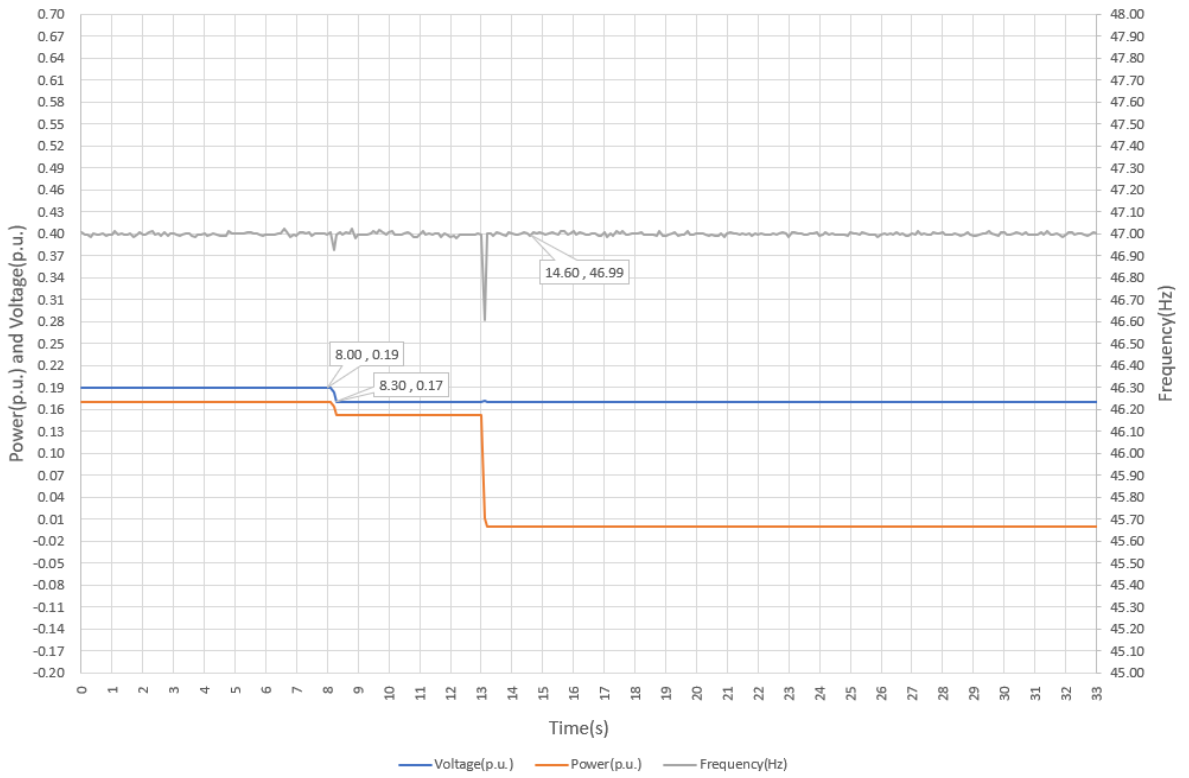

Underfrequency - Test 7: Trip time

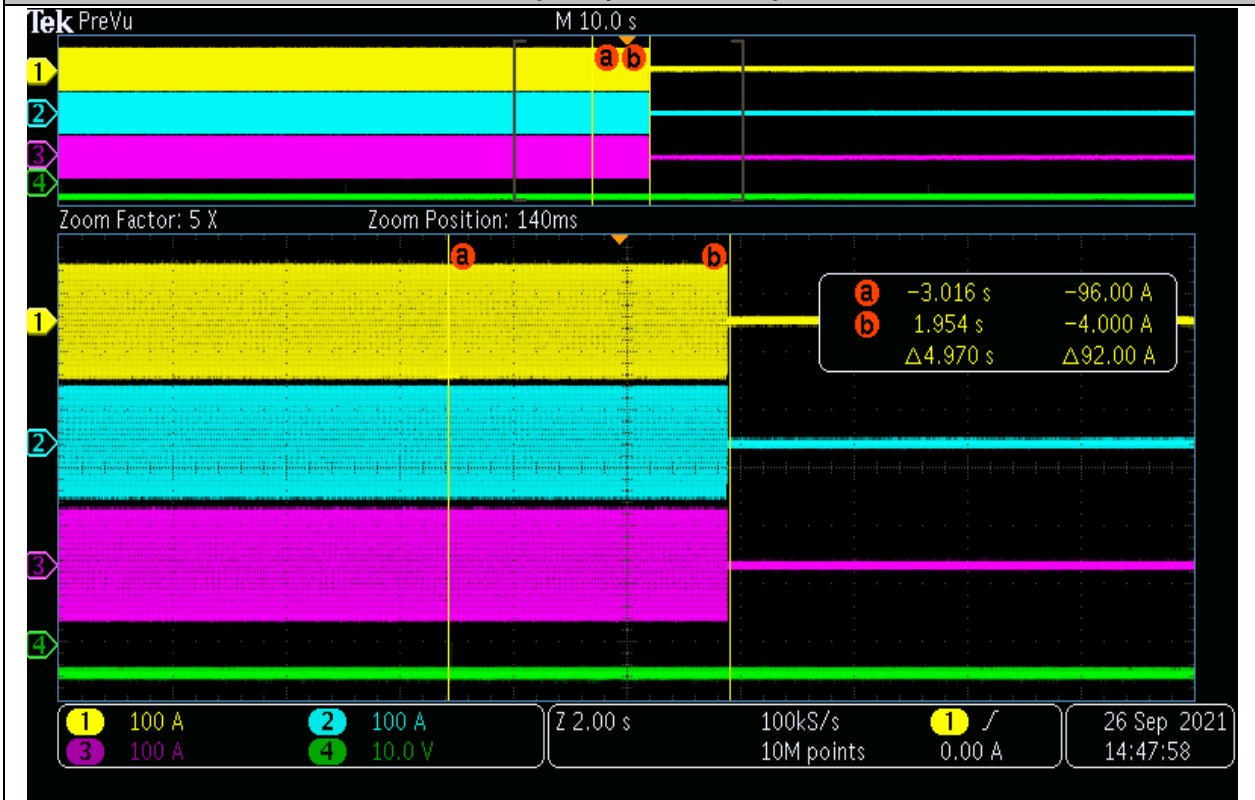

Underfrequency - Test 8: Trip value

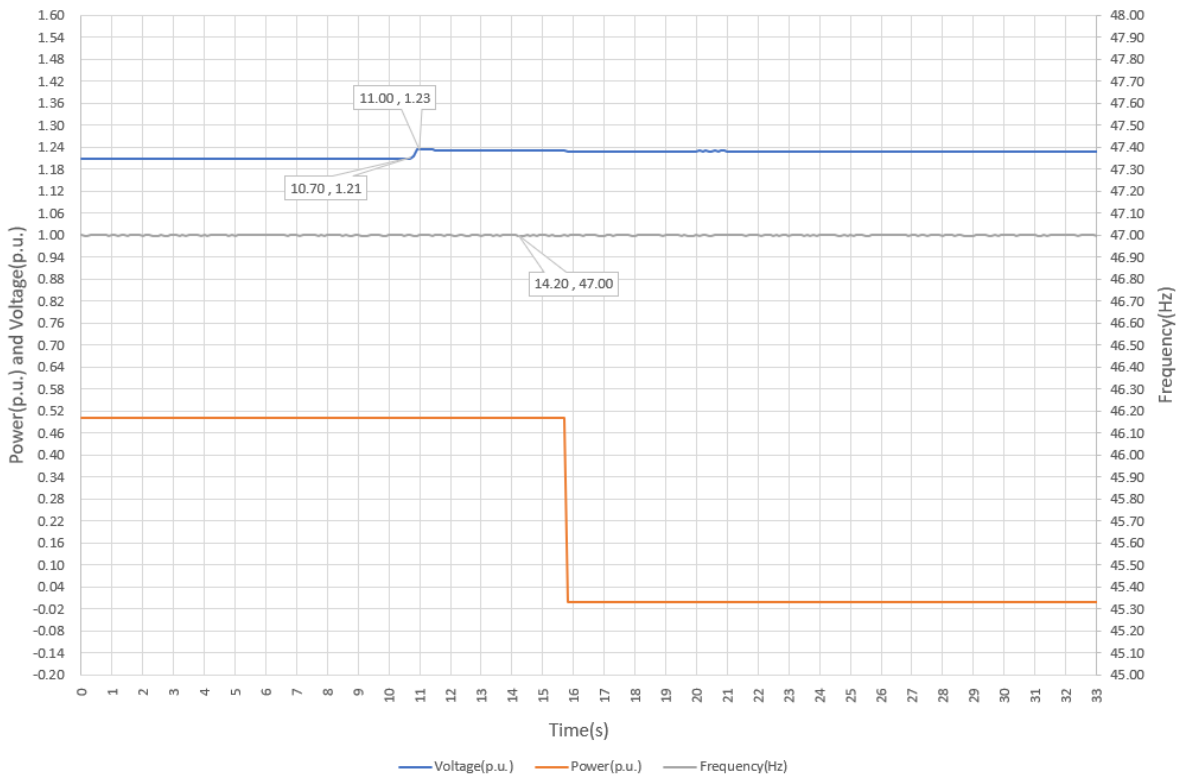

Underfrequency - Test 8: Trip time

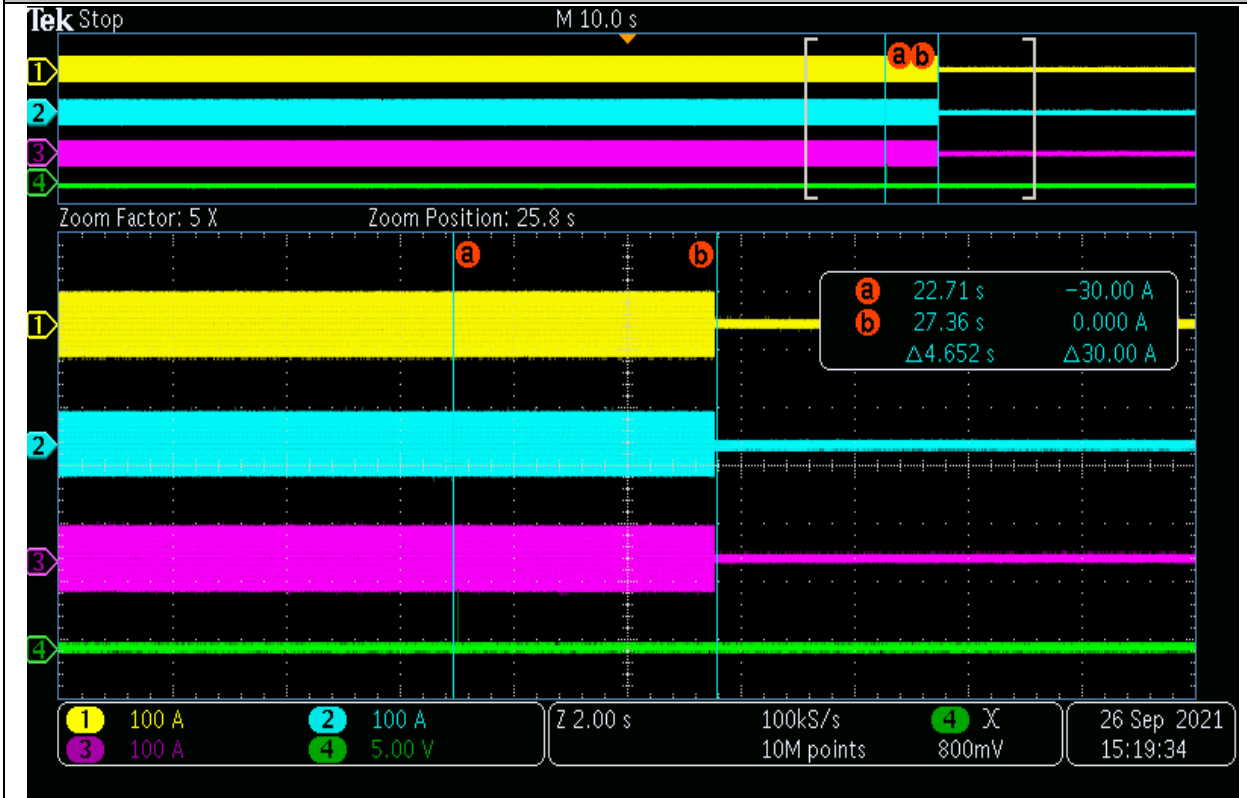

#### 4.6.1.5 Overfrequency protection

Overfrequency protection may be implemented with two completely independent protection thresholds, each one able to be activated or not. The standard adjustment ranges are as follows.

Overfrequency threshold stage 1 [81 >]:

- Threshold (50.0 – 52.0) Hz adjustment by steps of 0.1 Hz
- Operate time (0.1 – 100) s adjustable in steps of 0.1 s

Overfrequency threshold stage 2 [81 > >]:

- Threshold (50.0 – 52.0) Hz adjustment by steps of 0.1 Hz
- Operate time (0.1 - 5) s adjustable in steps of 0.05 s

In order to use narrow frequency thresholds for islanding detection (see4.9.3.3) it may be required to have the ability to activate and deactivate a stage by an external signal.

The frequency protection shall function correctly in the input voltage range between 20 %Un and 120 %Un and shall be inhibited for input voltages of less than 20 %Un.

The following definitions apply to the test to verify the clause:

Over frequency	Test No.	Frequency setting (Hz)	Frequency meas. (Hz)	Frequency deviation (Hz)	Trip time setting (s)	Trip time meas. (s)	Trip time deviation (s)
Stage 1 [81 >]	1	50.00	49.99	-0.01	100.000	100.000	0.000
	2	52.00	51.98	-0.02	0.100	0.078	-0.022
Stage 2 [81 > >]	3	50.00	50.00	0.00	5.000	4.998	-0.002
	4	52.00	51.98	-0.02	0.100	0.077	-0.023

Voltage protection threshold setting (p.u.)	Test No.	Frequency setting (Hz)	Voltage setting (p.u.)	Trip value meas.	Trip time setting (s)	Trip time meas. (s)	Trip time deviation (s)
0.18 & 1.22	5	52.00	0.21	52.04Hz	5.000	5.000	0.000
	6	52.00	1.19	52.05Hz	5.000	5.000	0.000
	7	52.00	0.19	51.99Hz	Not protected	--	--
		52.00	0.17	51.99Hz	5.000	4.772	-0.228
	8	47.00	1.21	52.00Hz	Not protected	--	--
		47.00	1.23	52.00Hz	5.000	5.000	0.000

Note: Tests 7 and 8 are comprised by two different steps, the first was to verify the no trip value, and the second step was to verify the trip time.

Test results are represented at diagrams below.

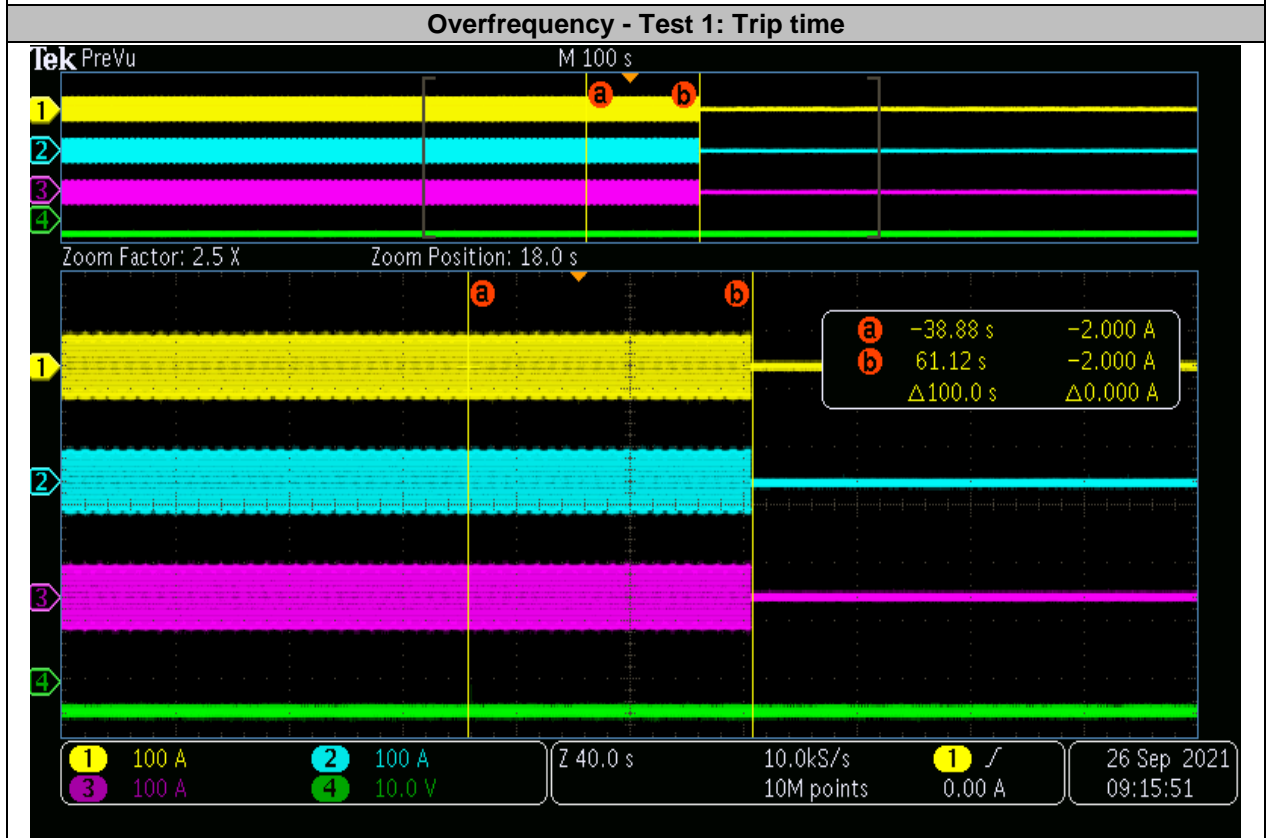
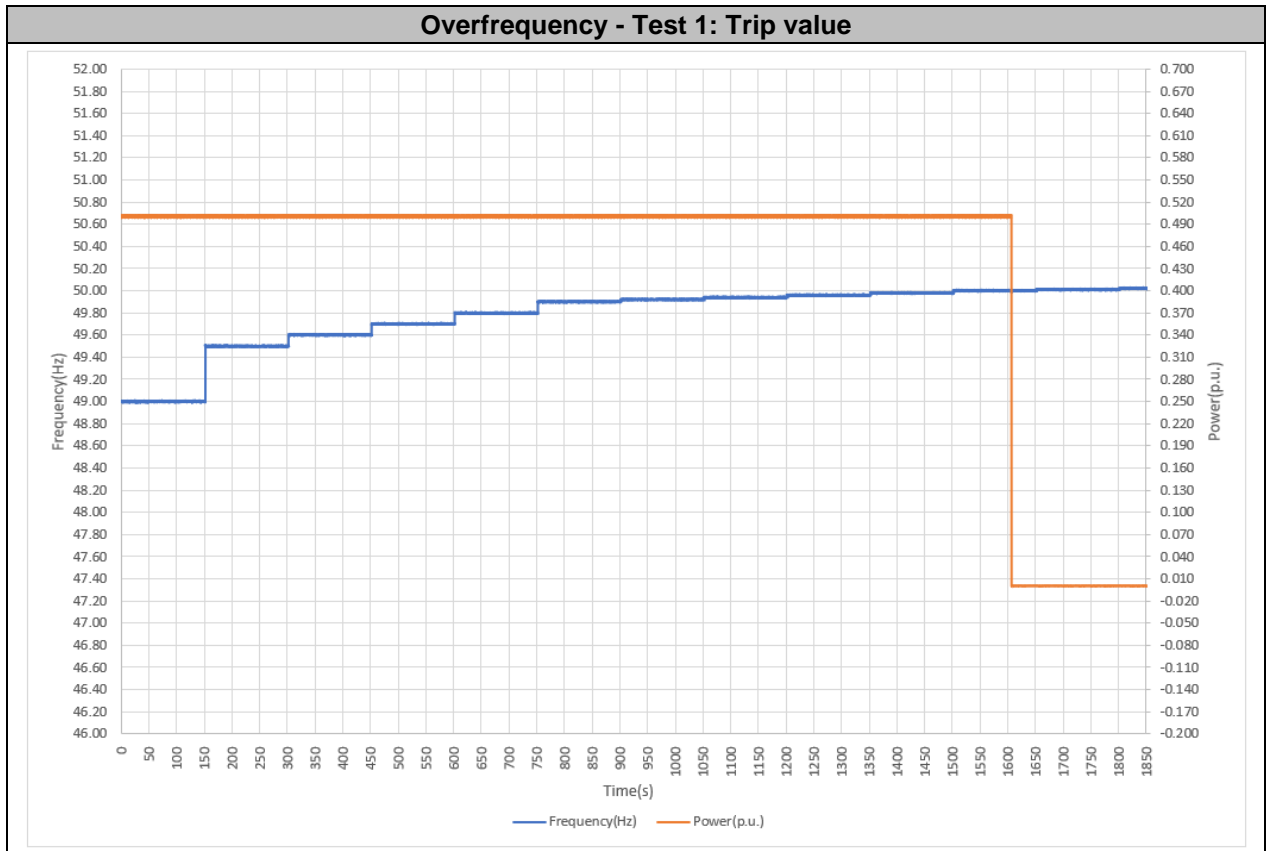



Overfrequency - Test 2: Trip value

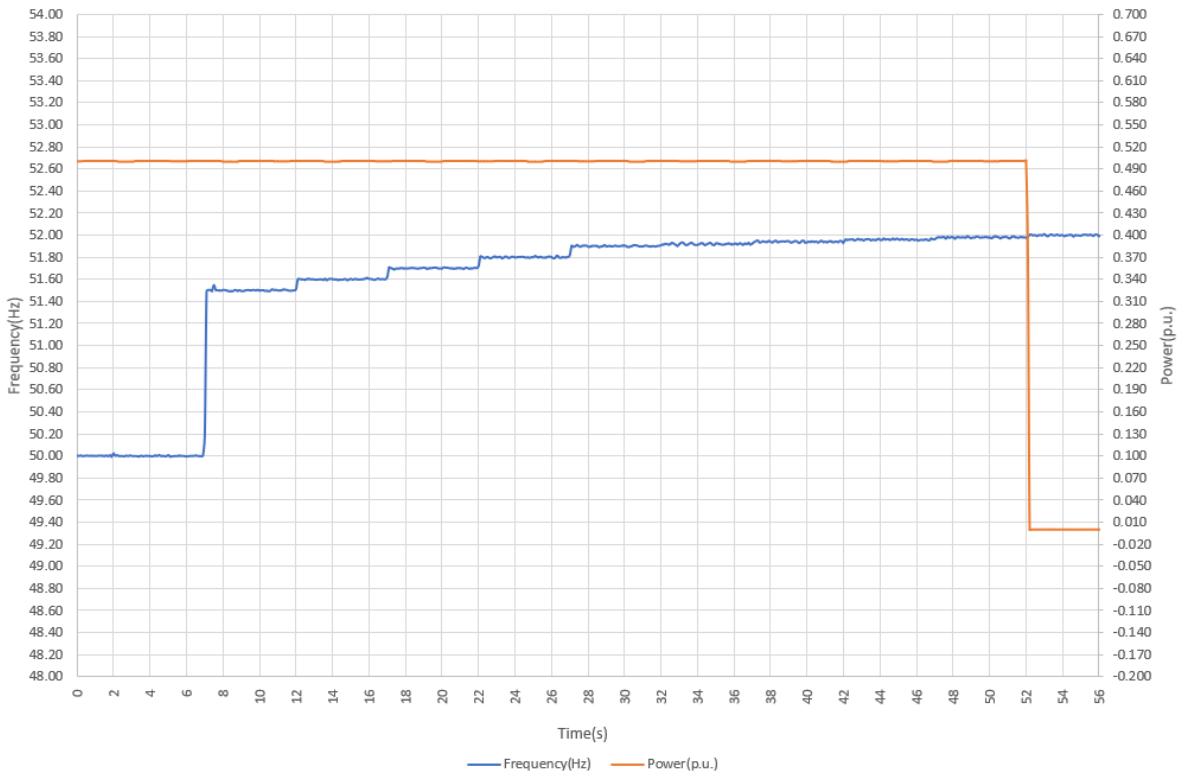

Overfrequency - Test 2: Trip time

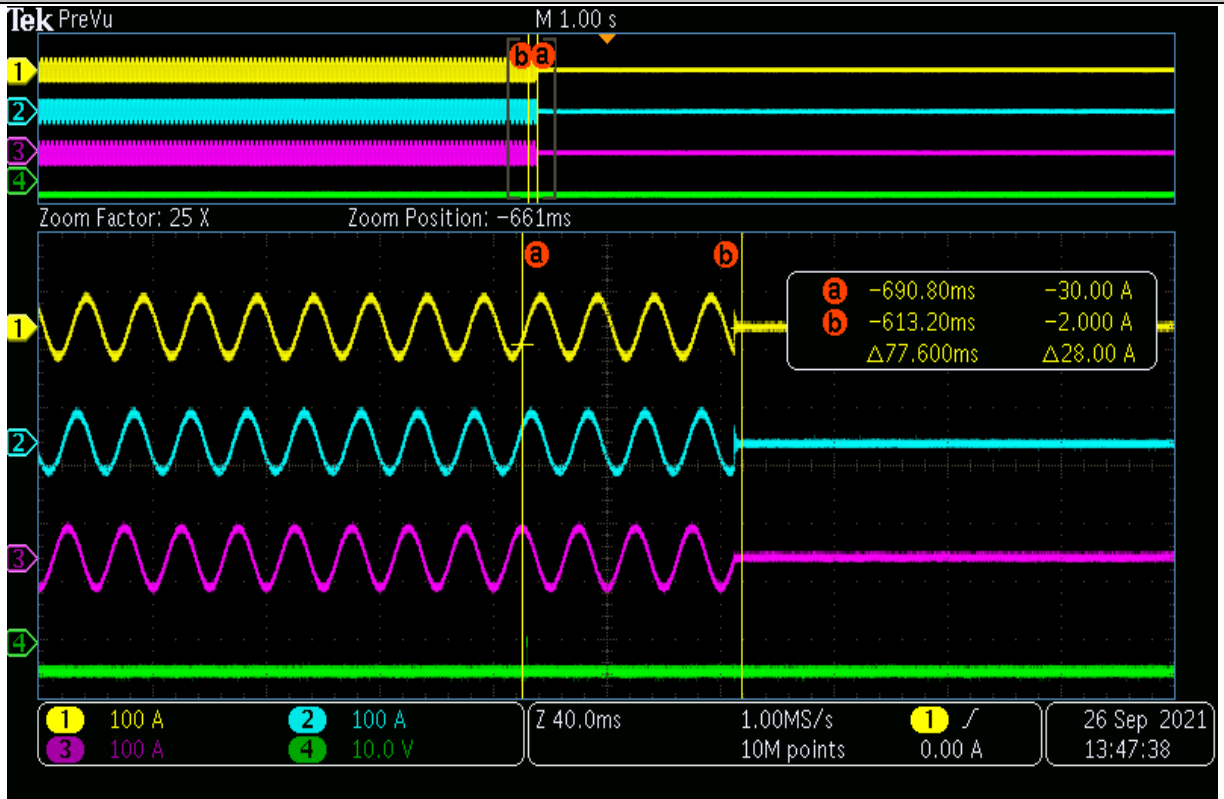

Overfrequency - Test 3: Trip value

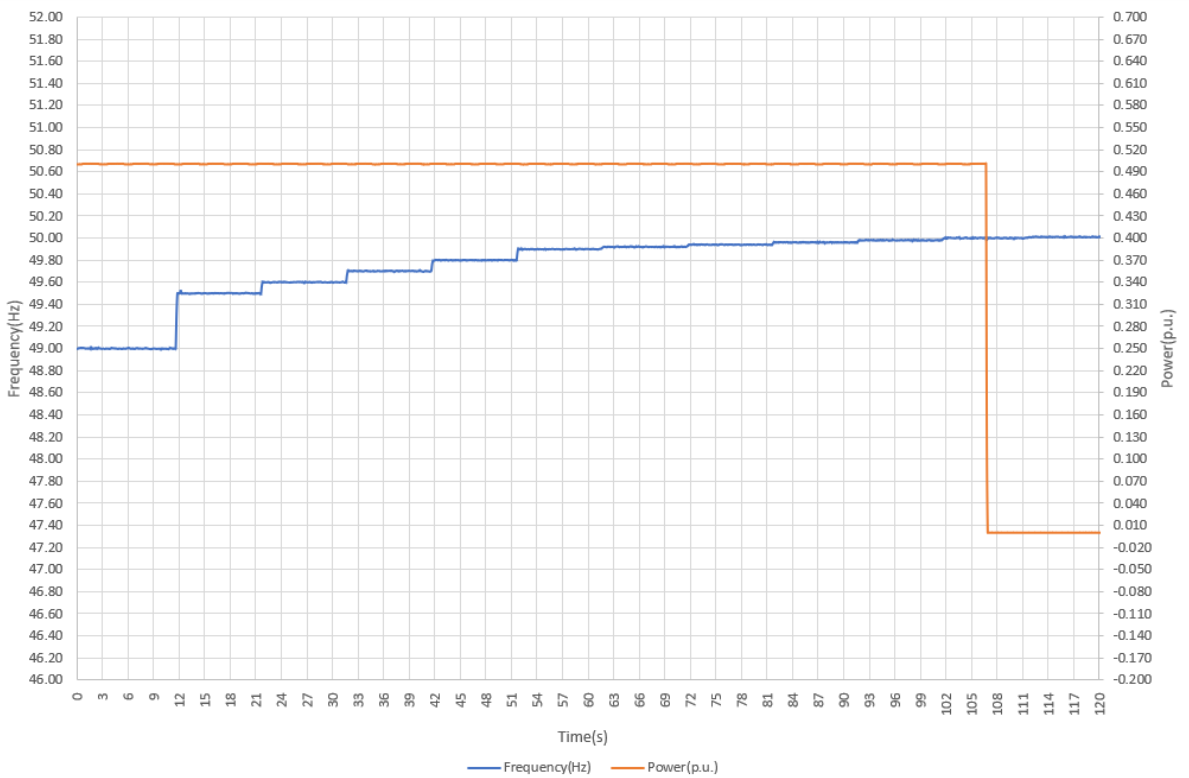

Overfrequency - Test 3: Trip time

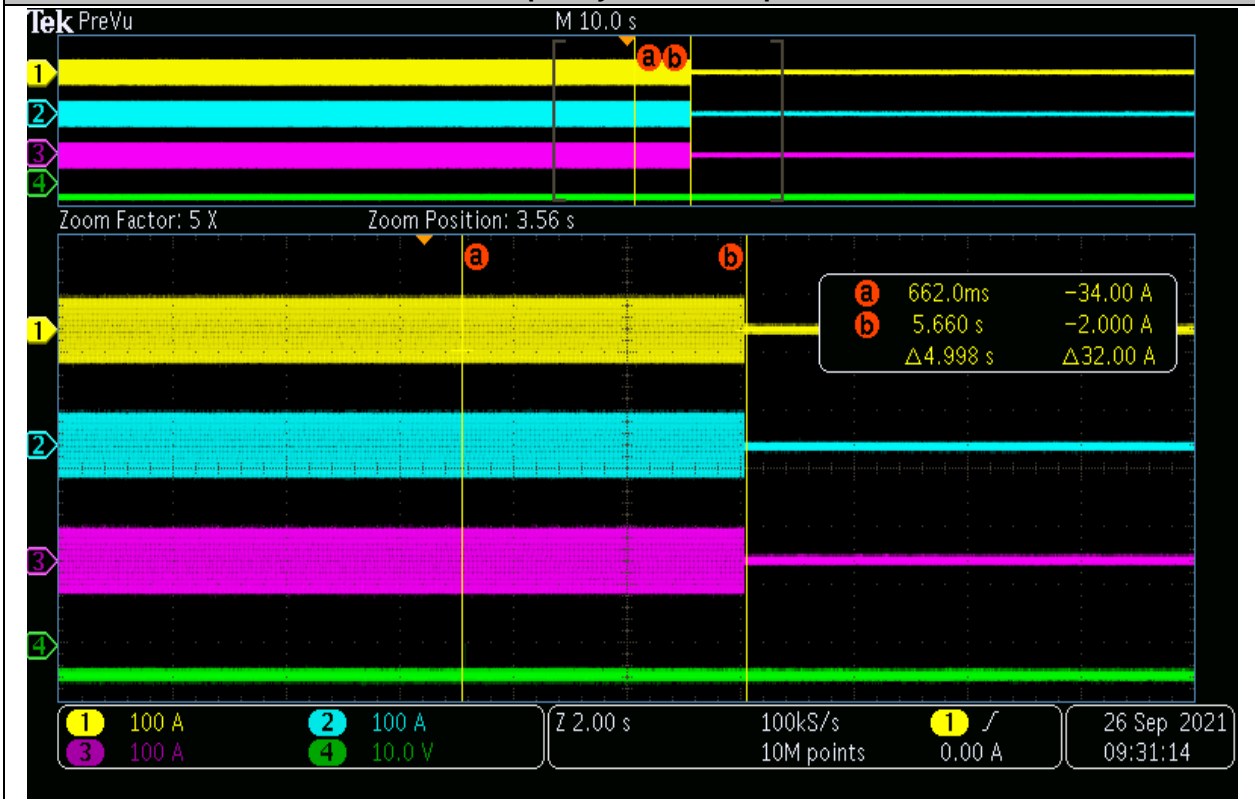

Overfrequency - Test 4: Trip value

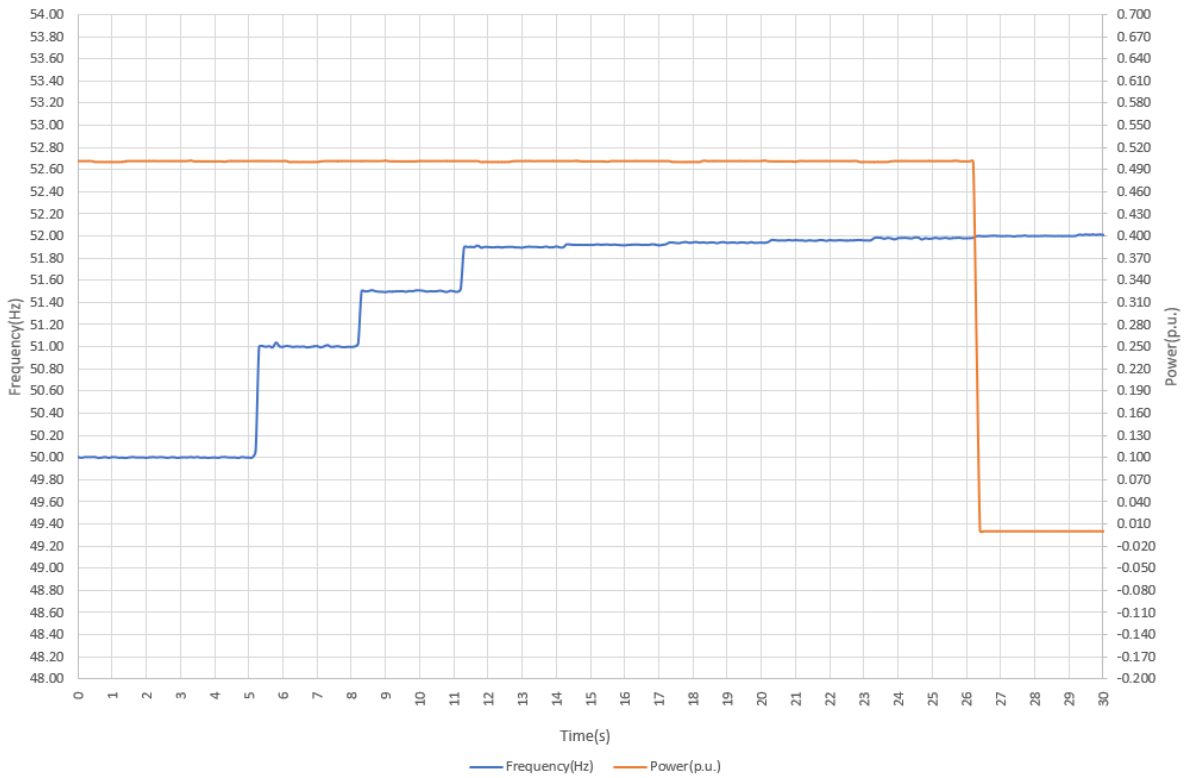

Overfrequency - Test 4: Trip time

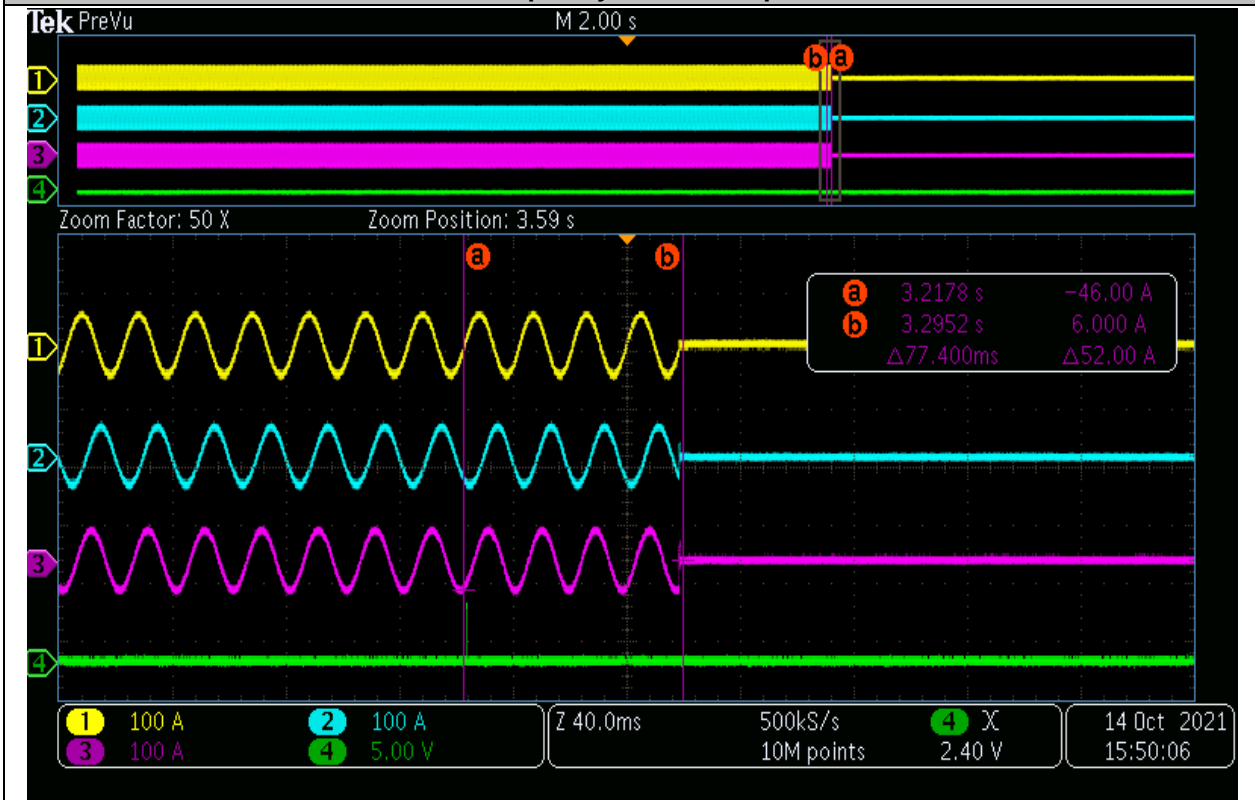

Overfrequency - Test 5: Trip value

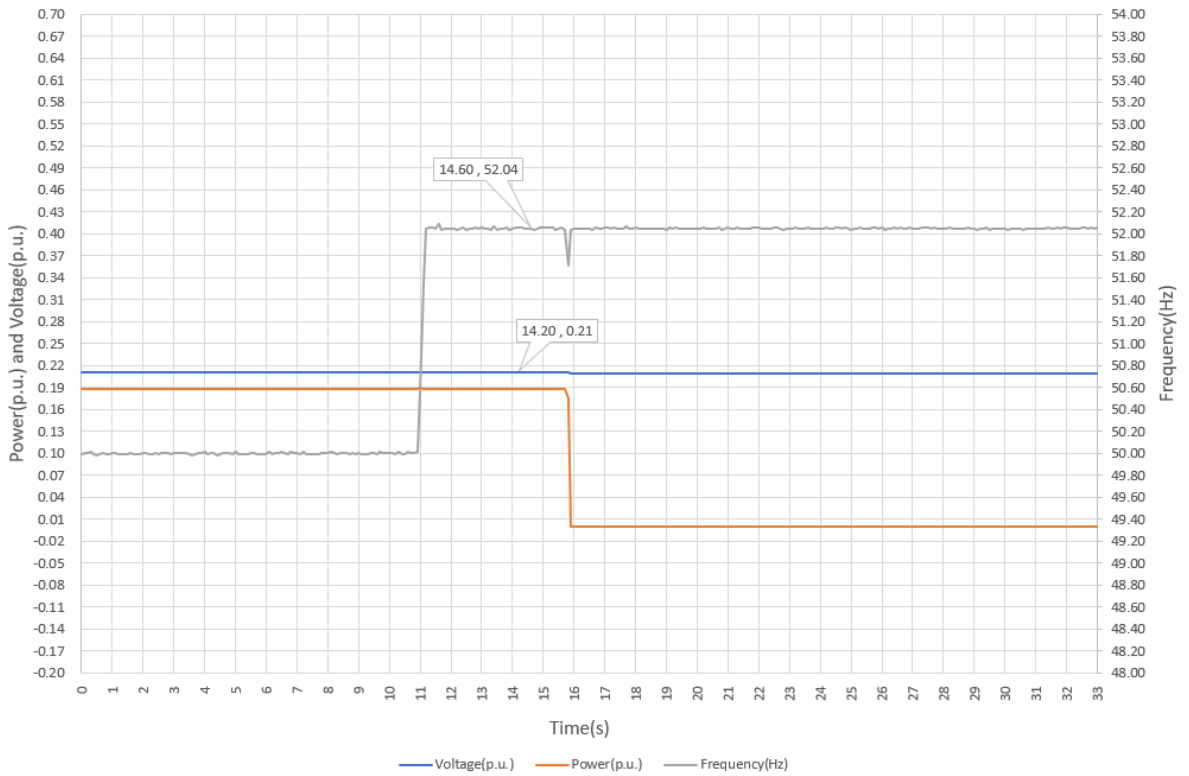

Overfrequency - Test 5: Trip time

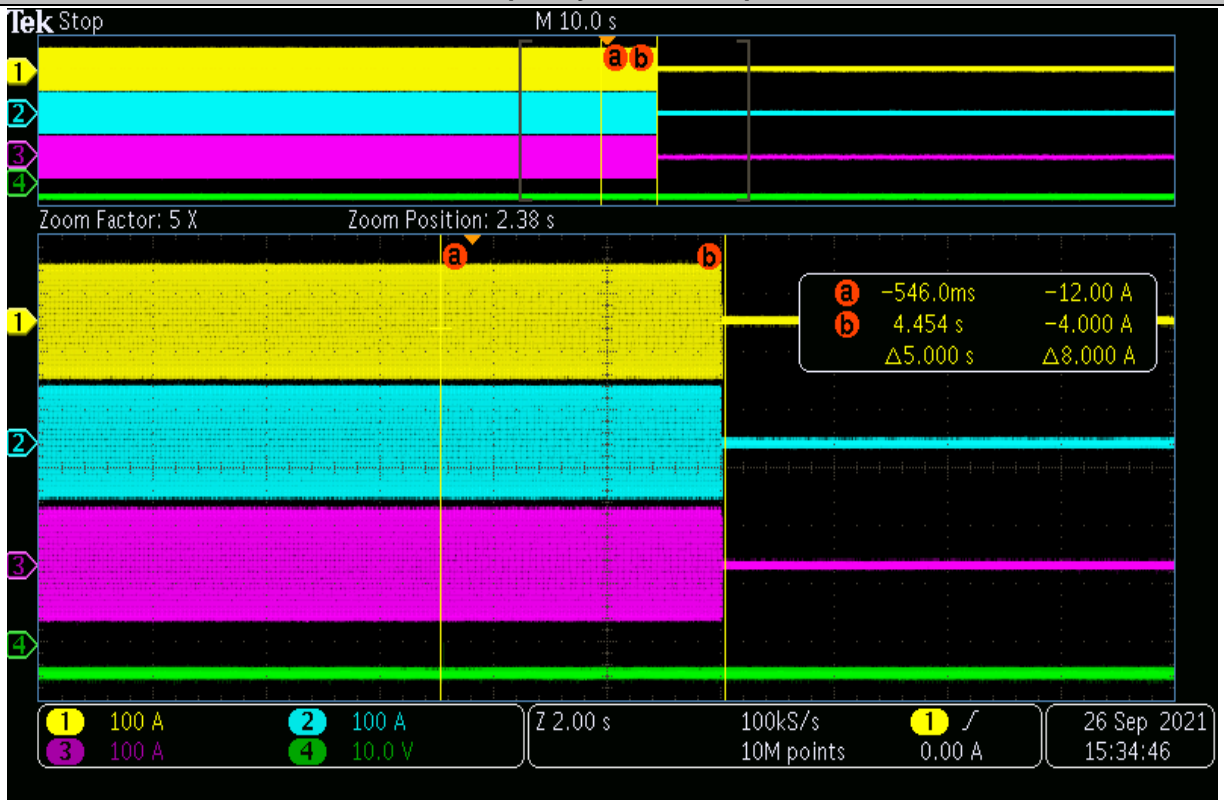

Overfrequency - Test 6: Trip value

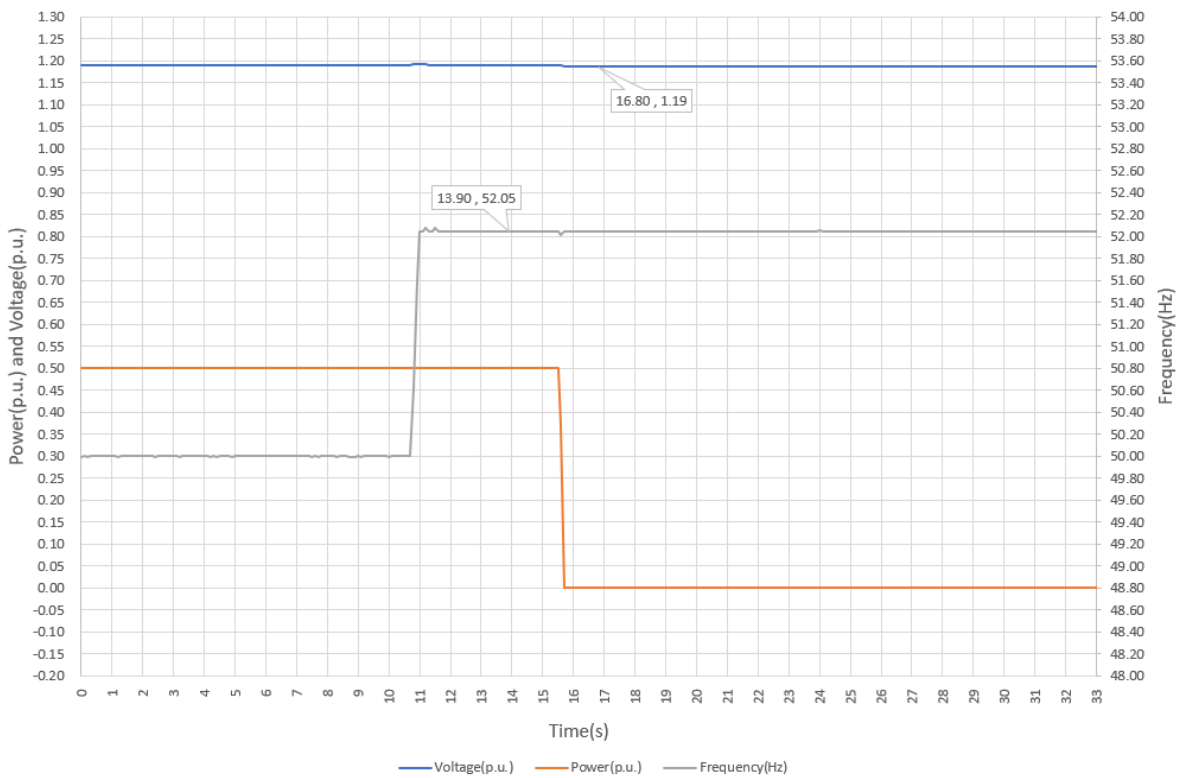

Overfrequency - Test 6: Trip time

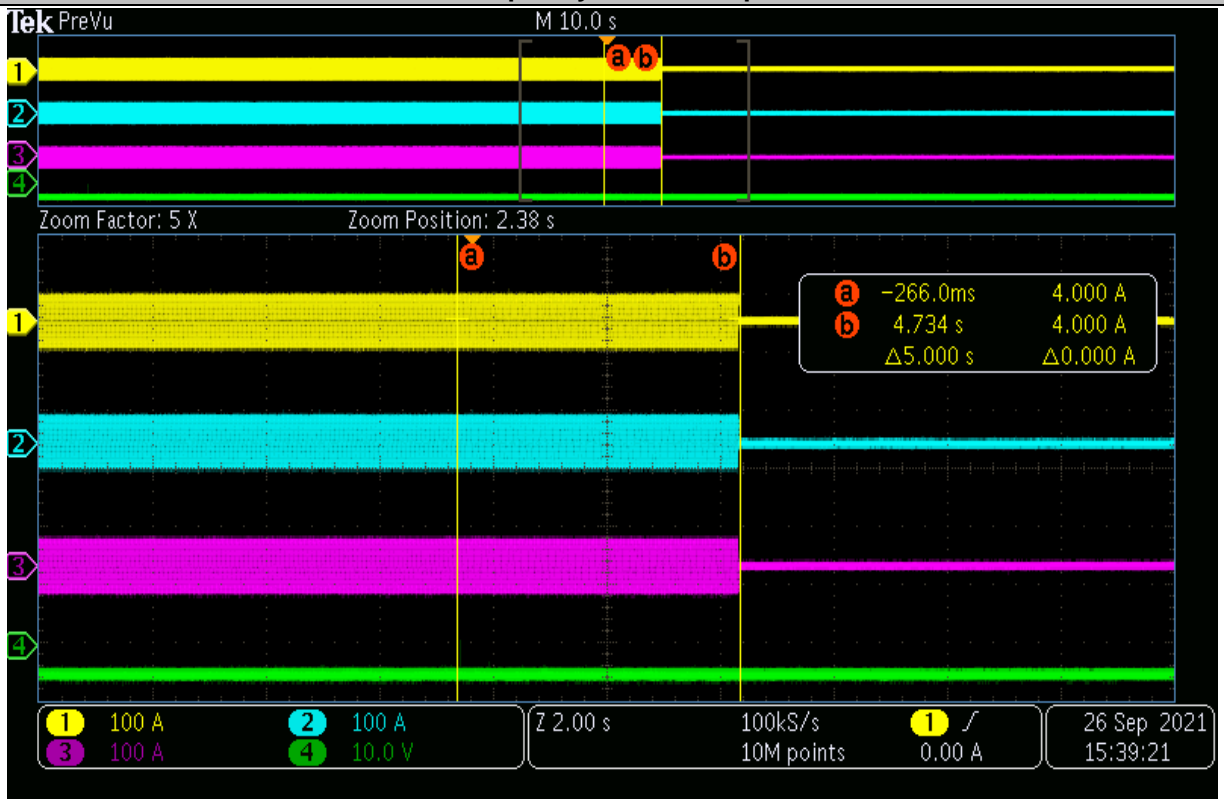

Overfrequency - Test 7: Trip value

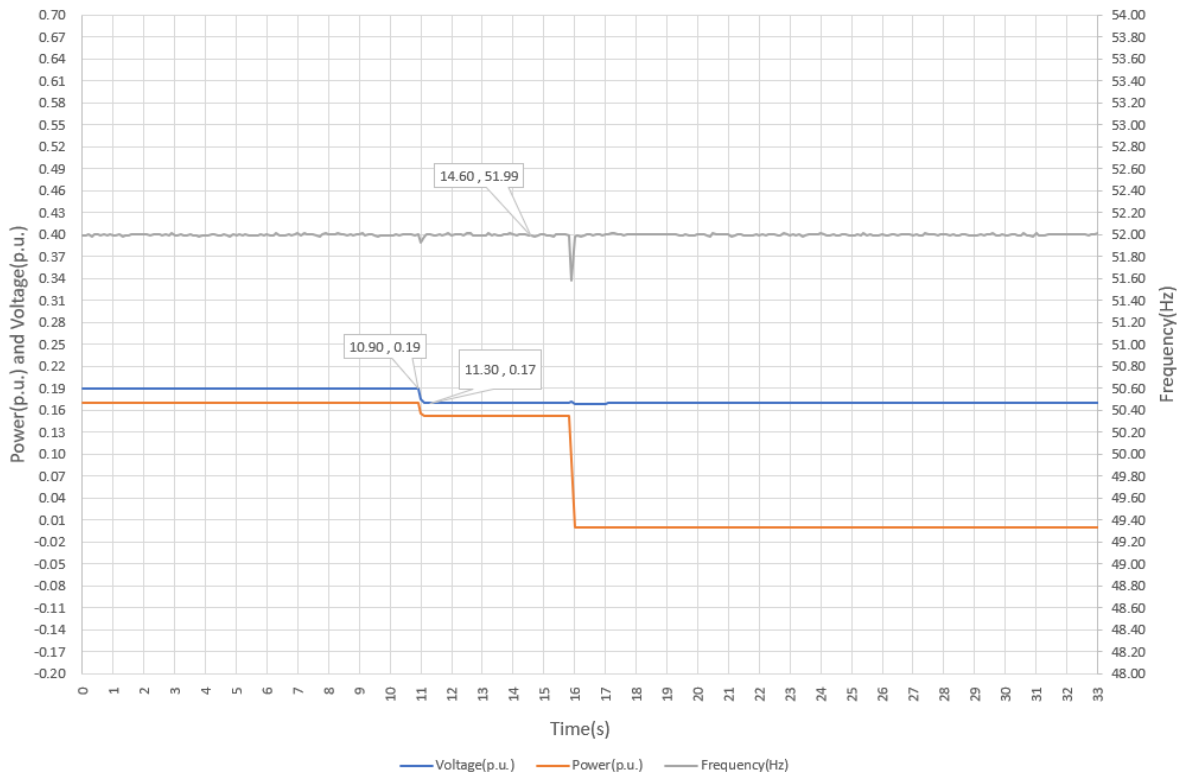

Overfrequency - Test 7: Trip time

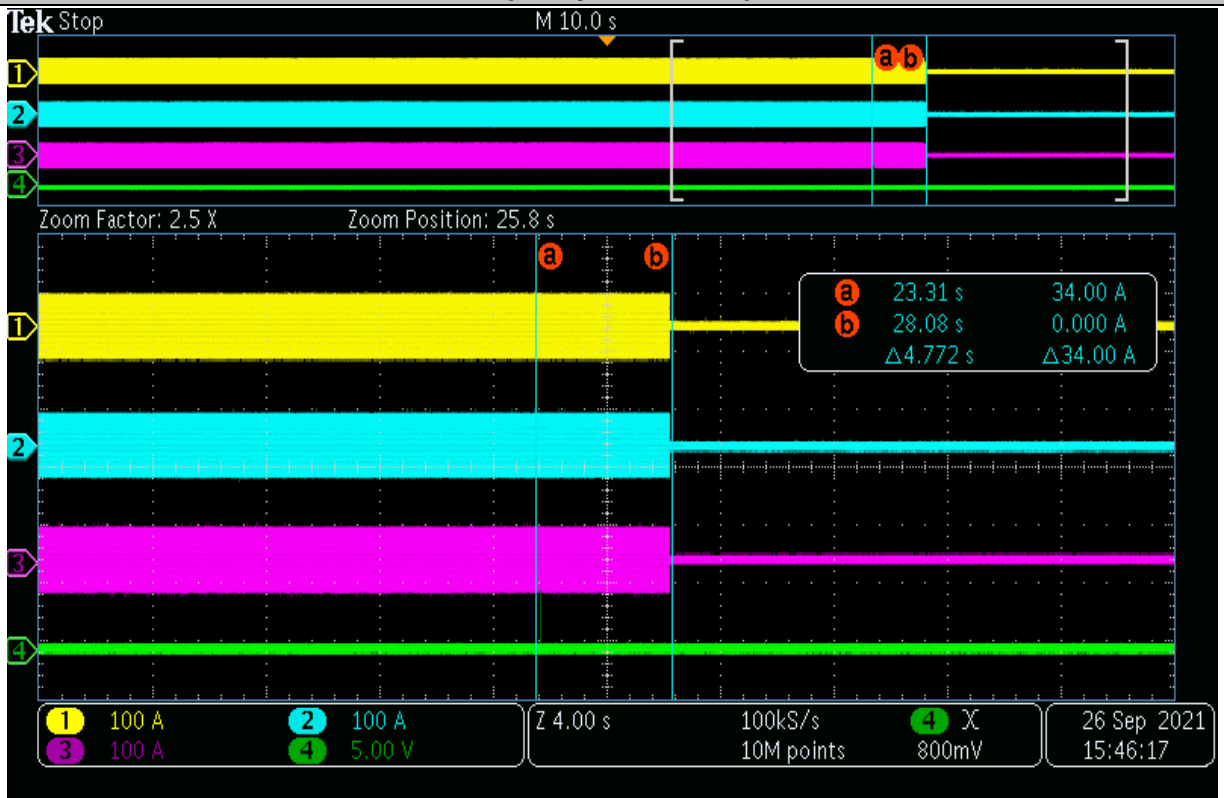

Overfrequency - Test 8: Trip value

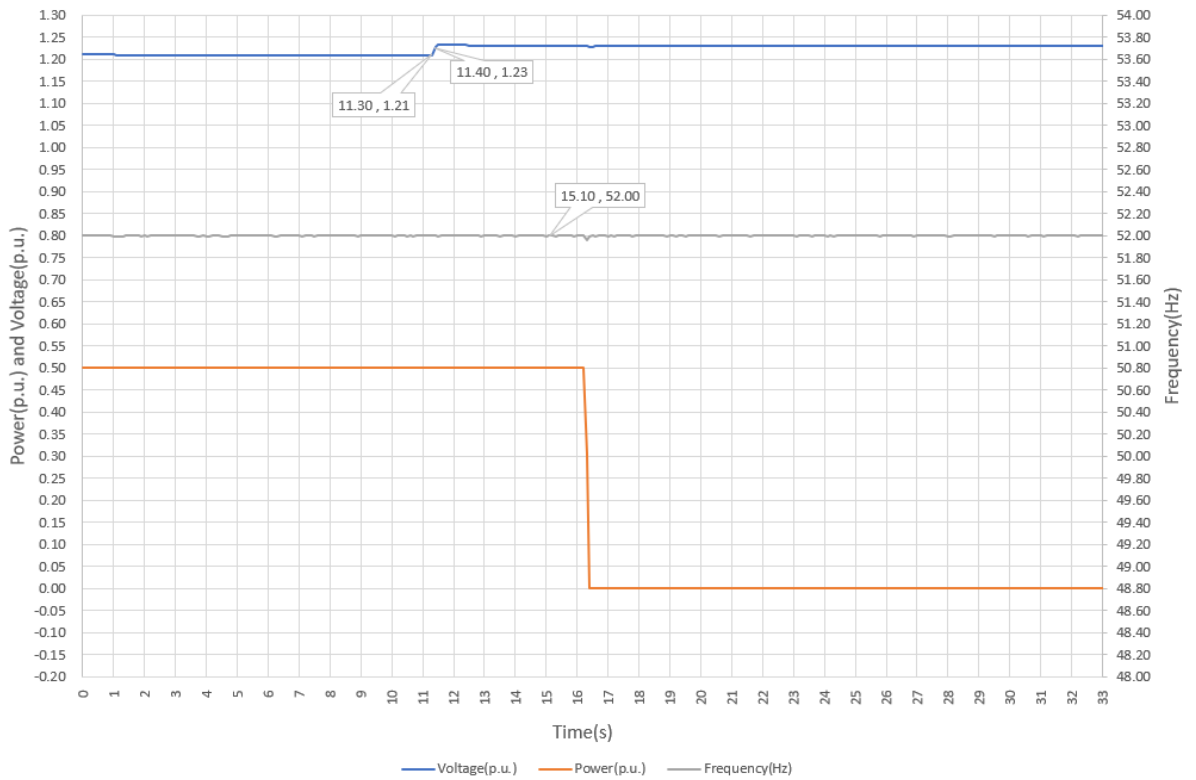

Overfrequency - Test 8: Trip time

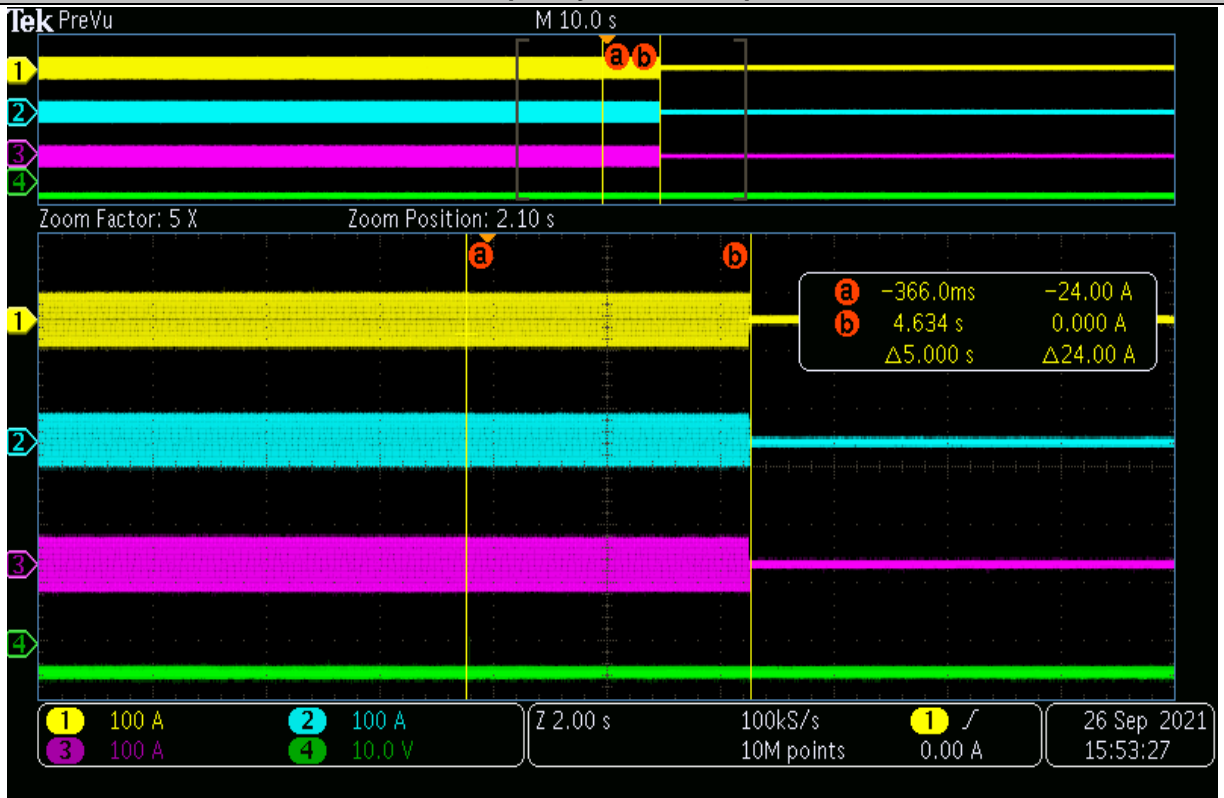

**4.6.2. Requirements on voltage and frequency protection (Country / Region included in the default settings: Ireland)**

Add test **A.13 IE – Ireland** for interface protection according to chapter 4.6.2 and Table 4 of the standard EN 50438: 2013 as following:

Parameter	Clearance time (s)	Trip setting
Over-voltage	0.5	230 V + 10%
Under-voltage	0.5	230 V - 10%
Over-frequency	0.5	50 Hz + 1%
Under-frequency	0.5	50 Hz - 4%
An explicit Loss of Mains functionality shall be included. Established methods such as, but not limited to, Rate of Change of Frequency, Vector Shift or Source Impedance Measurement may be used. Where Source Impedance is measured, this shall be achieved by purely passive means. Any implementation which involves the injection of pulses onto the distribution network, shall not be permitted.		
ROCOF (where used)	0.5	0.4 Hz/s
Vector Shift (where used)	0.5	6°

The minimum required accuracy is:

- for frequency measurement  $\pm 0.05$  Hz;
- for voltage measurement  $\pm 1$  % of  $U_n$ .

Note: Active methods tested with a resonant circuit used for detecting islanding situations. The testing method is according to IEC 62116.

**4.6.2.1 Undervoltage protection (Country / Region: Ireland)**

Undervoltage of 90% $U_n$				
Phase A				
Parameter	Settings	Test 1	Test 2	Test 3
Trip value [V]	207	207.2	207.2	207.2
Trip time [s]	< 0.500	0.477	0.487	0.485
Phase B				
Parameter	Settings	Test 1	Test 2	Test 3
Trip value [V]	207	206.8	207.0	207.0
Trip time [s]	< 0.500	0.487	0.497	0.489
Phase C				
Parameter	Settings	Test 1	Test 2	Test 3
Trip value [V]	207	205.9	206.0	206.0
Trip time [s]	< 0.500	0.490	0.490	0.484
Phase ABC				
Parameter	Settings	Test 1	Test 2	Test 3
Trip value [V]	207	207.1	207.1	207.0
Trip time [s]	< 0.500	0.487	0.493	0.465



Test results are represented at diagrams below.

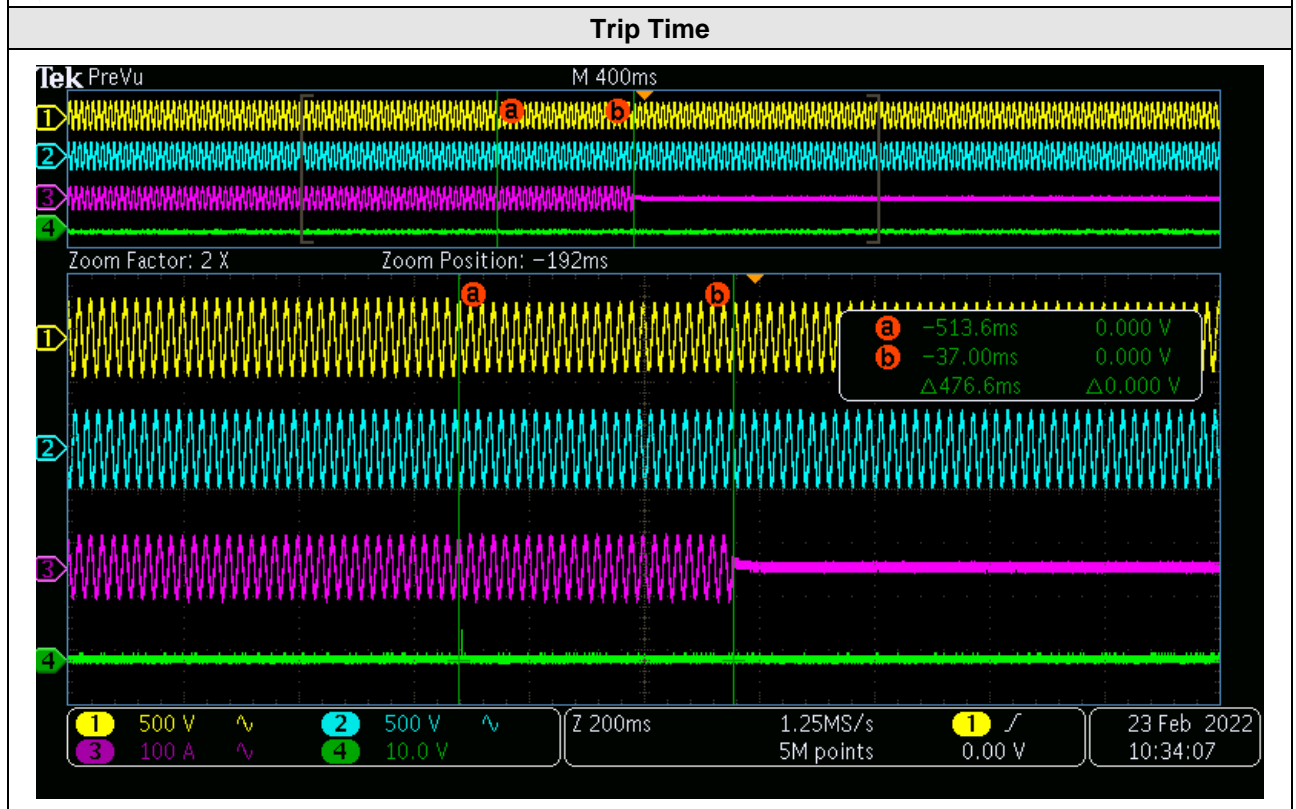

Phase A of Test 2

Trip Value

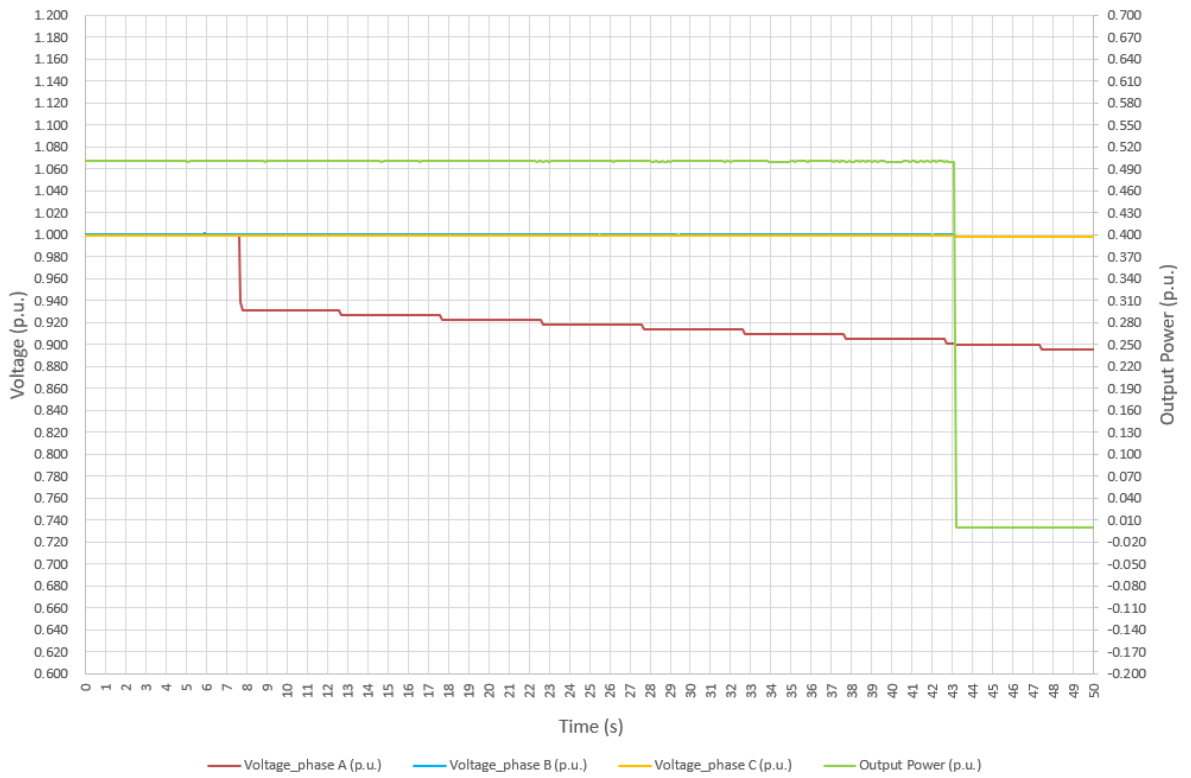

Trip Time

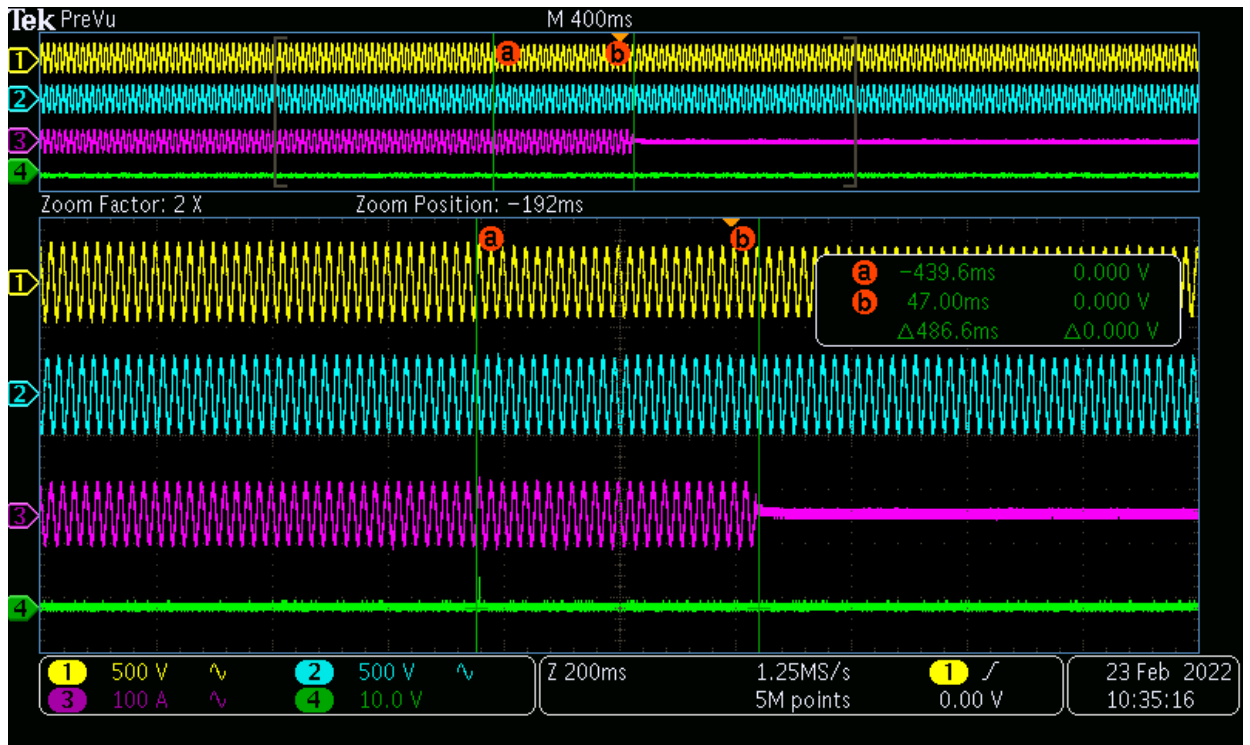

Phase A of Test 3

Trip Value



Trip Time

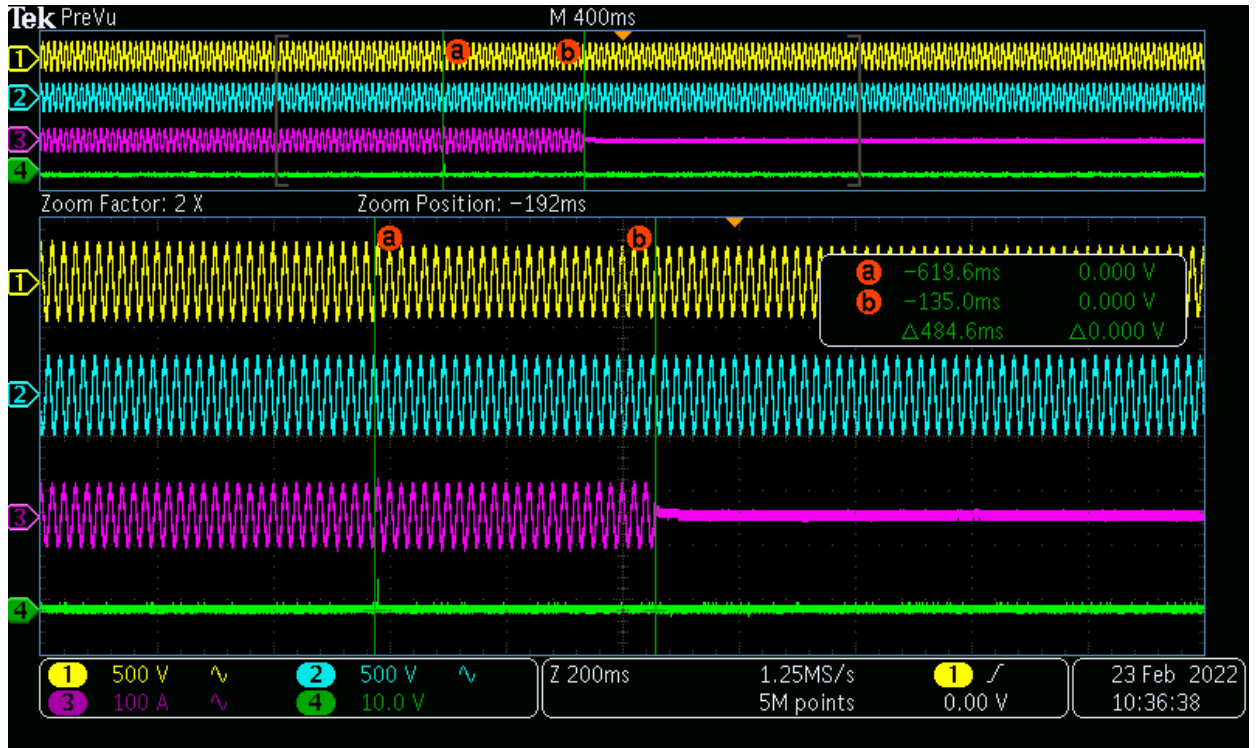

Phase B of Test 1

Trip Value



Trip Time

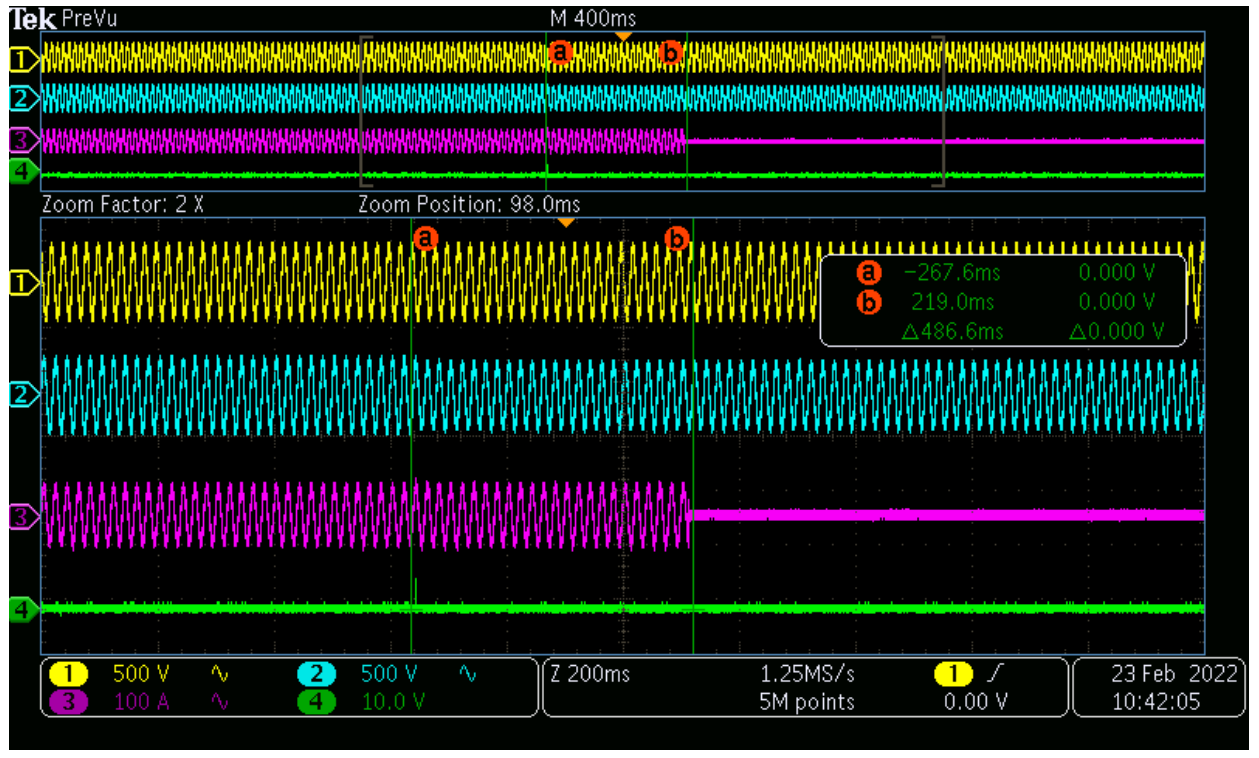

Phase B of Test 2

Trip Value

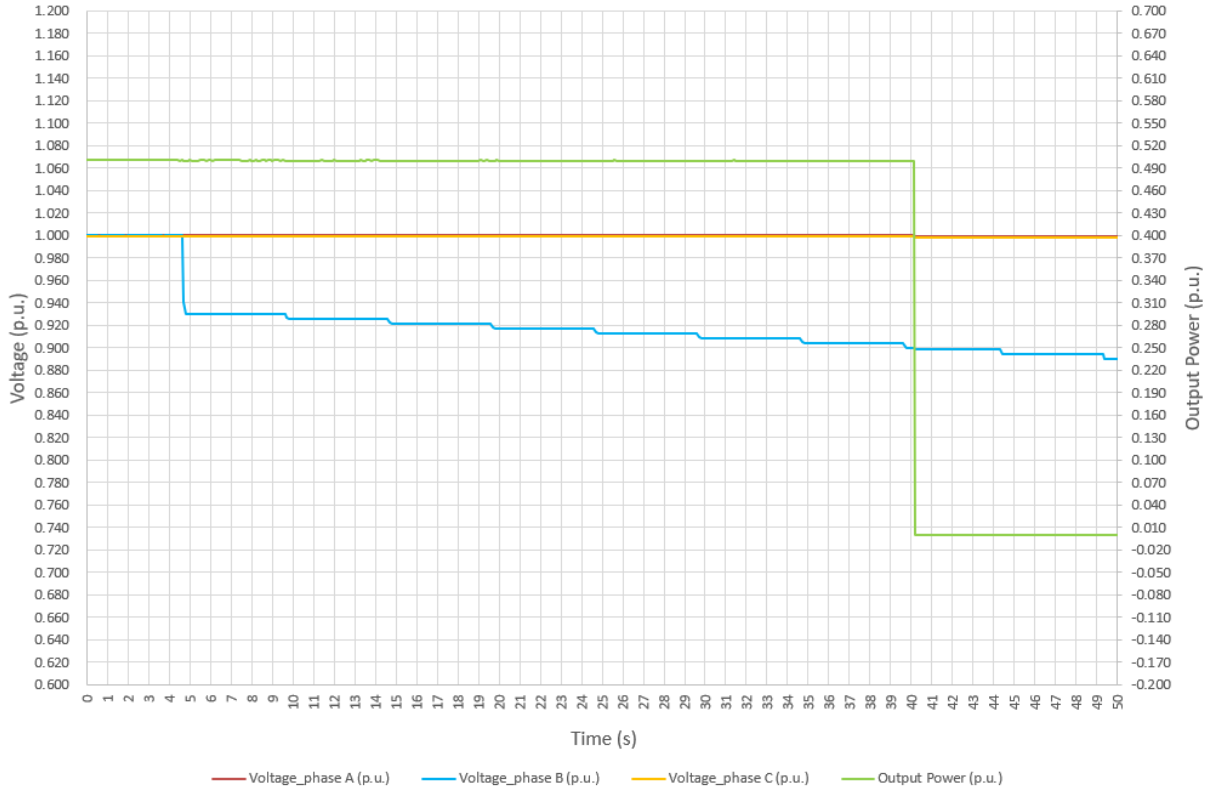

Trip Time

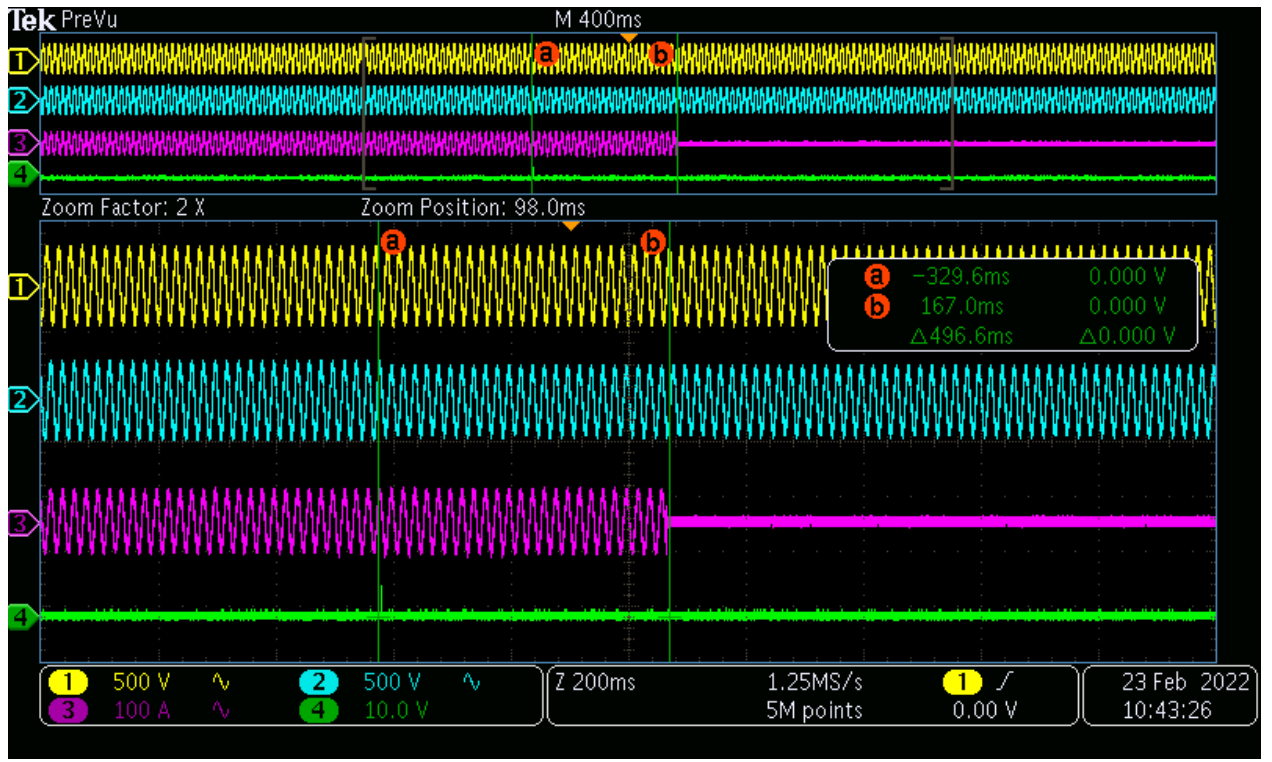

Phase B of Test 3

Trip Value

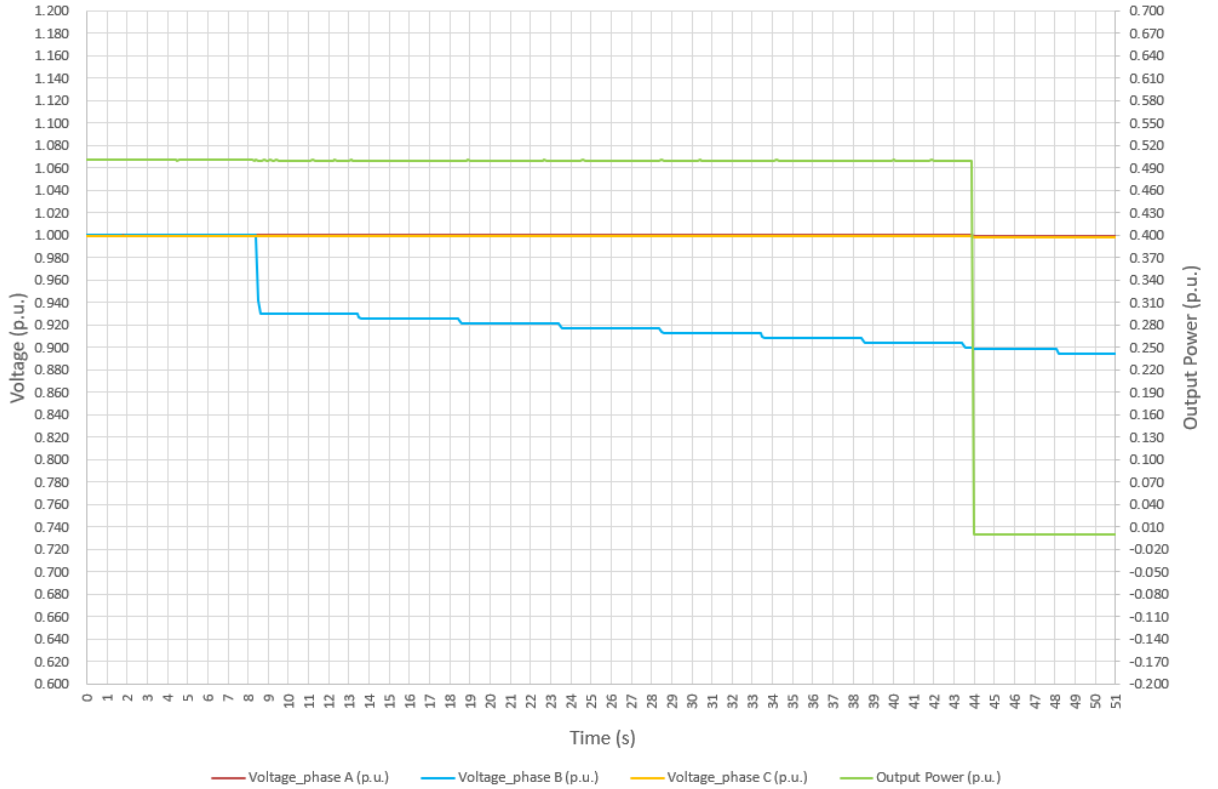

Trip Time

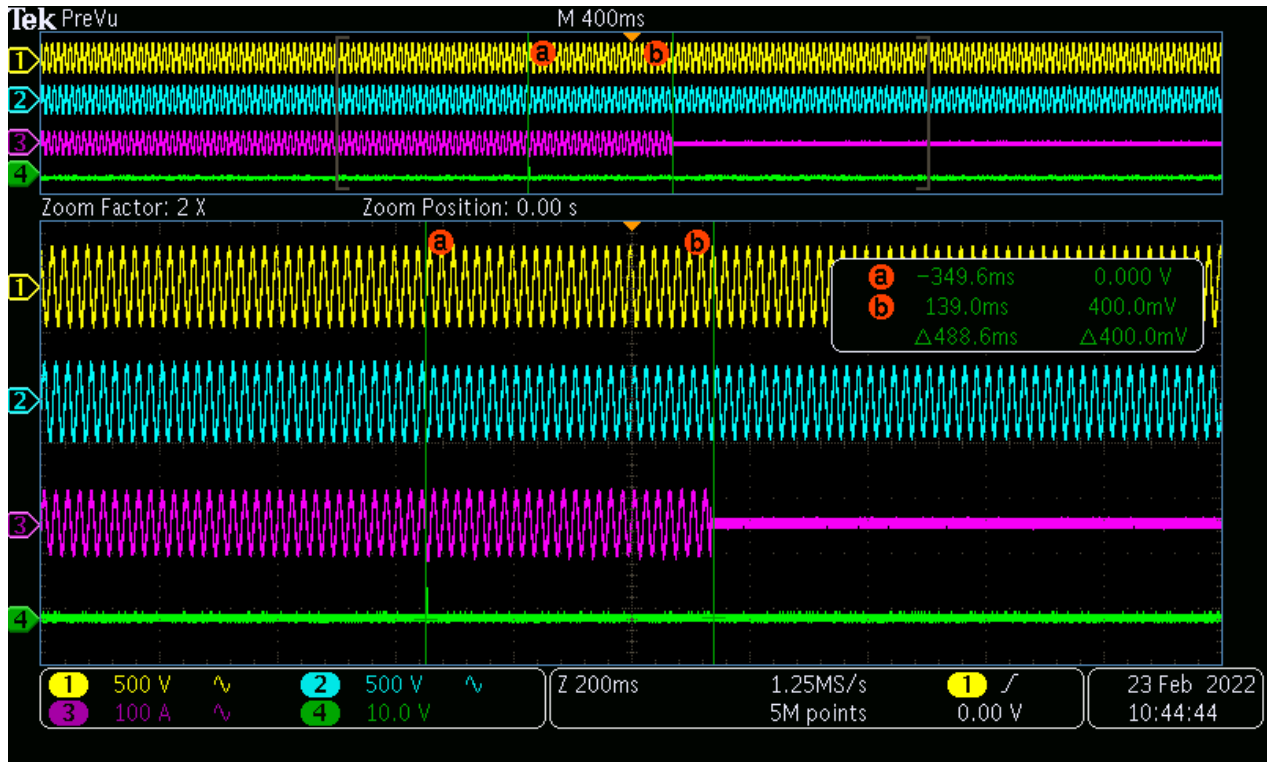

Phase C of Test 1

Trip Value

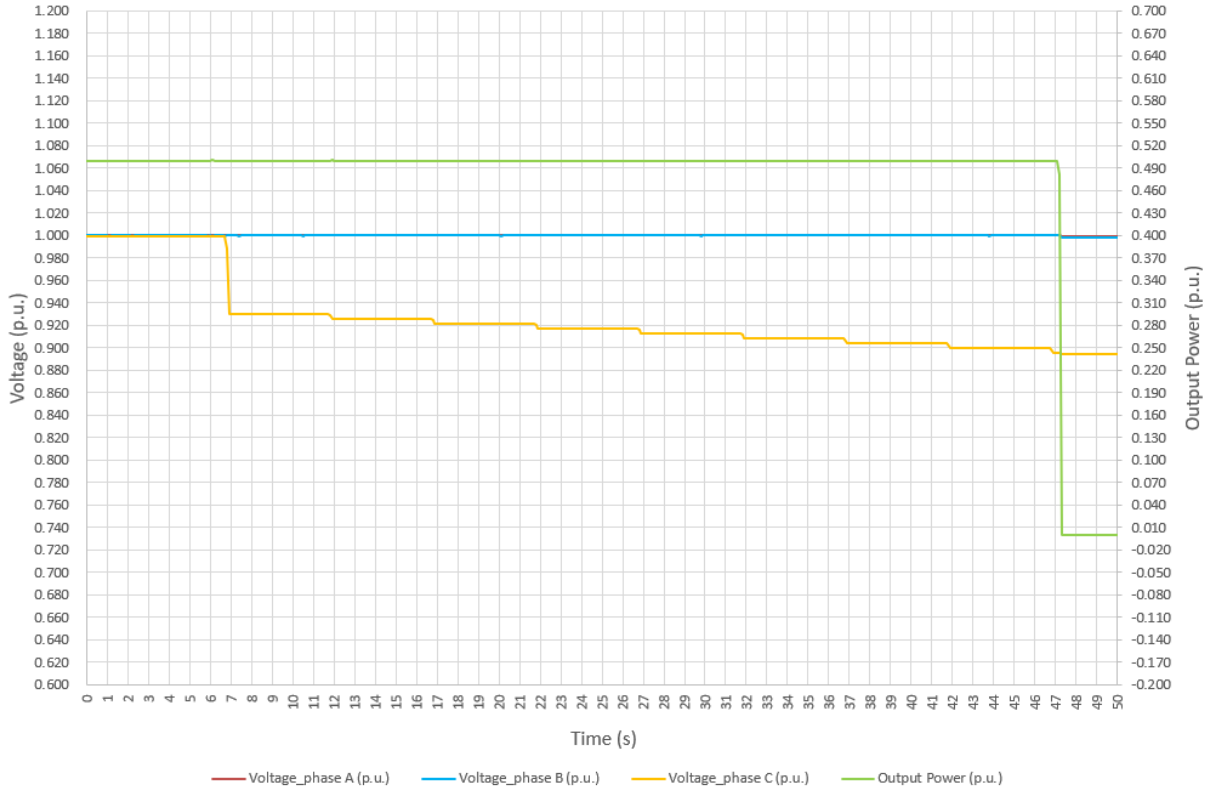

Trip Time

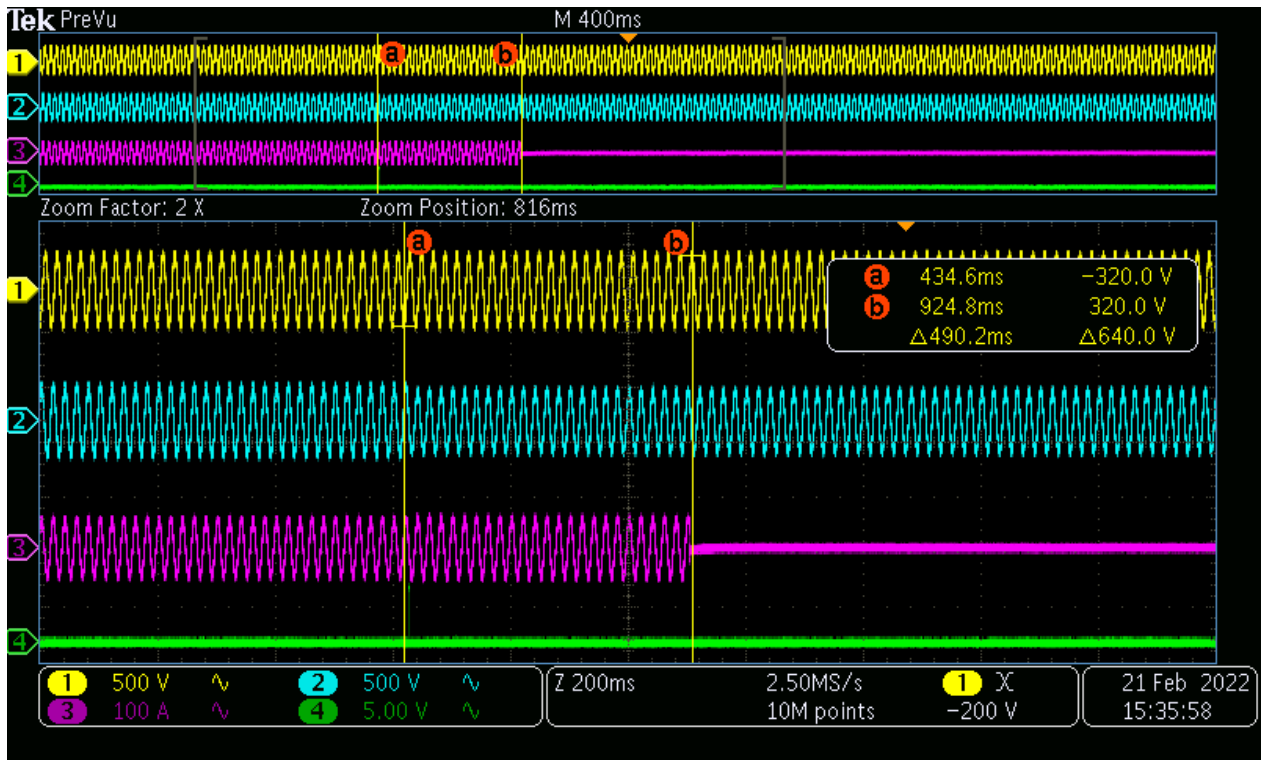

Phase C of Test 2

Trip Value

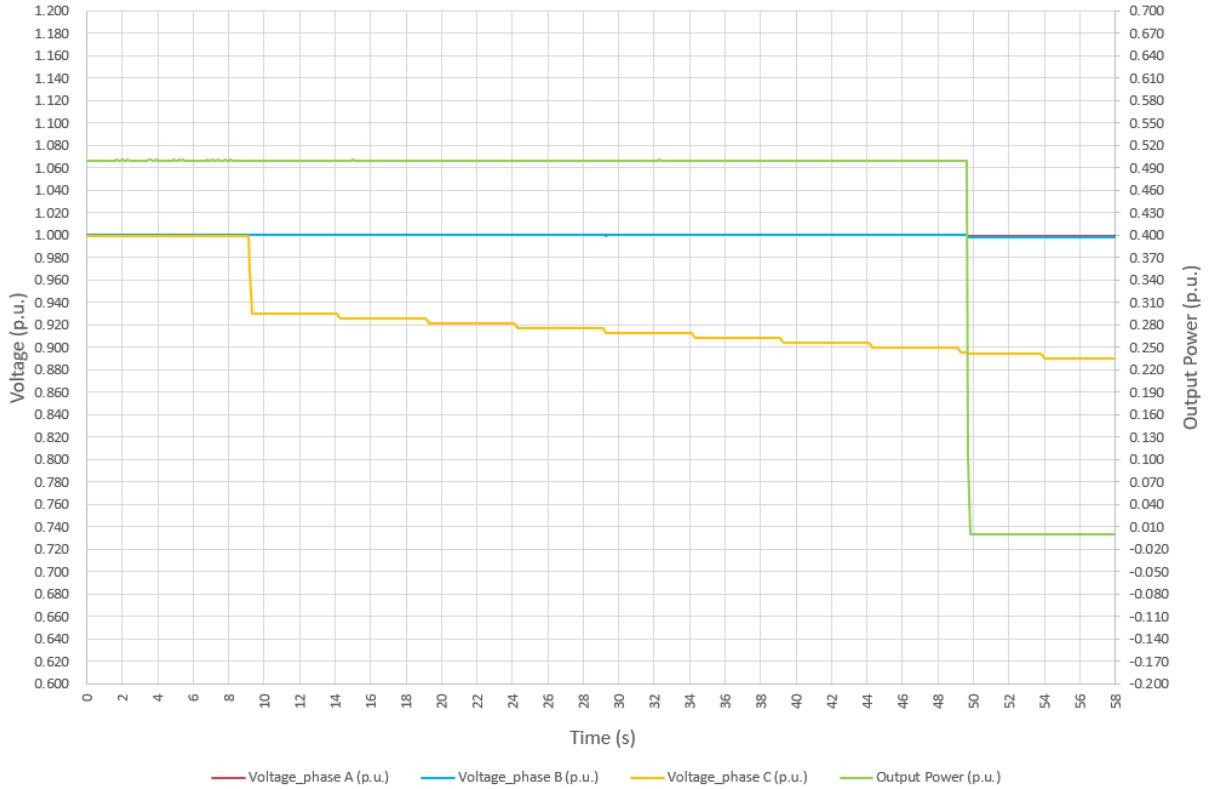

Trip Time

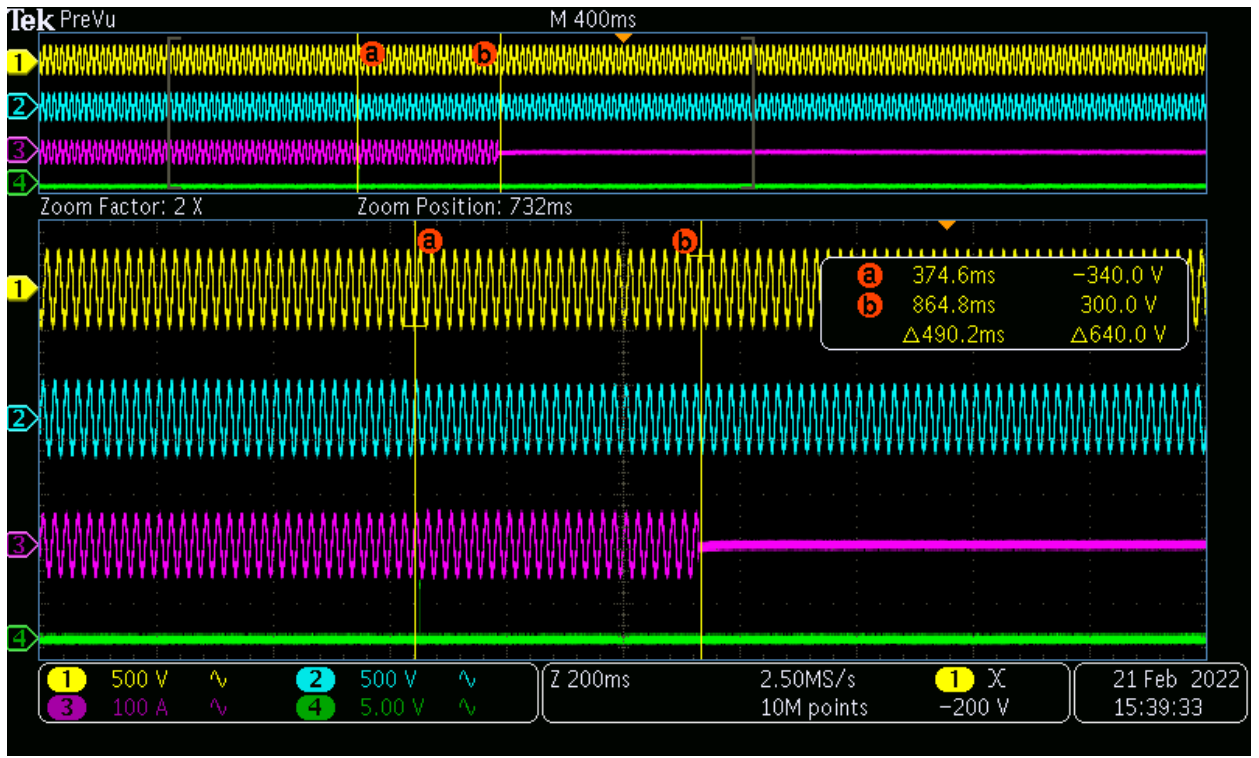



Phase C of Test 3

Trip Value



Trip Time

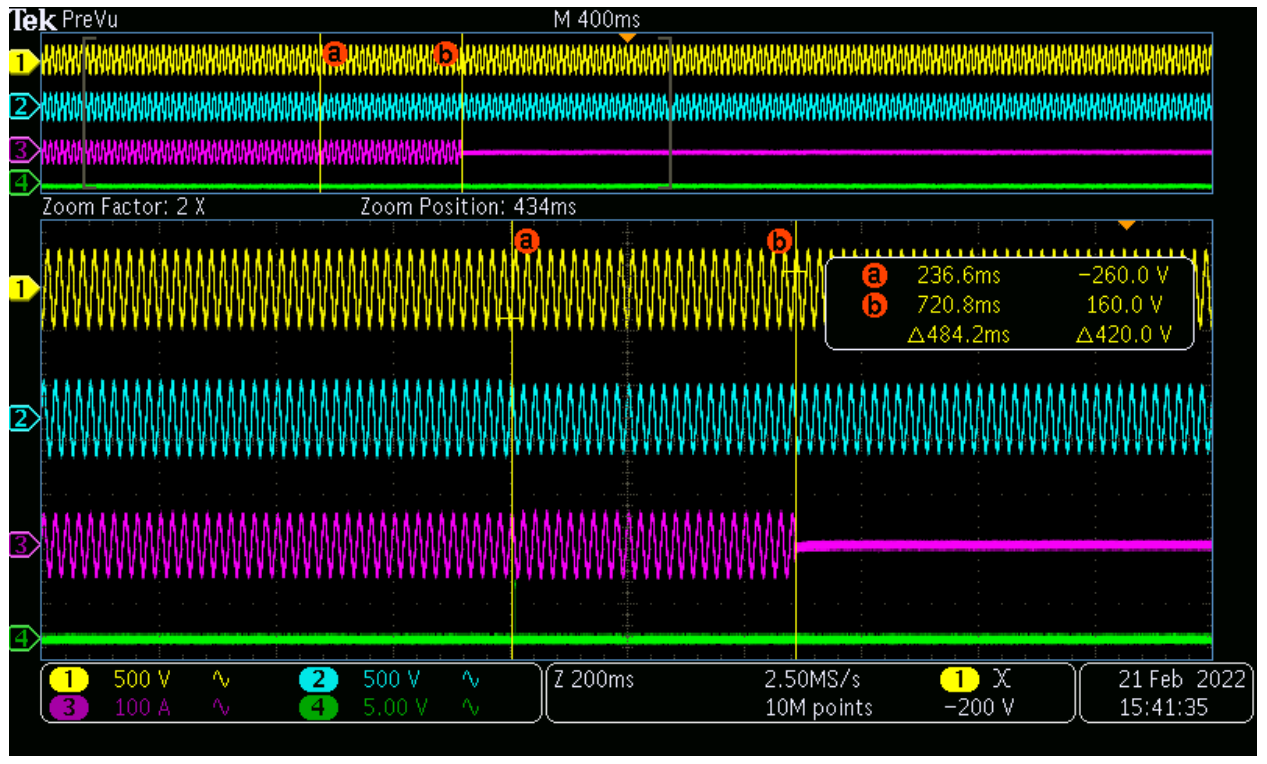

Phase ABC of Test 1

Trip Value

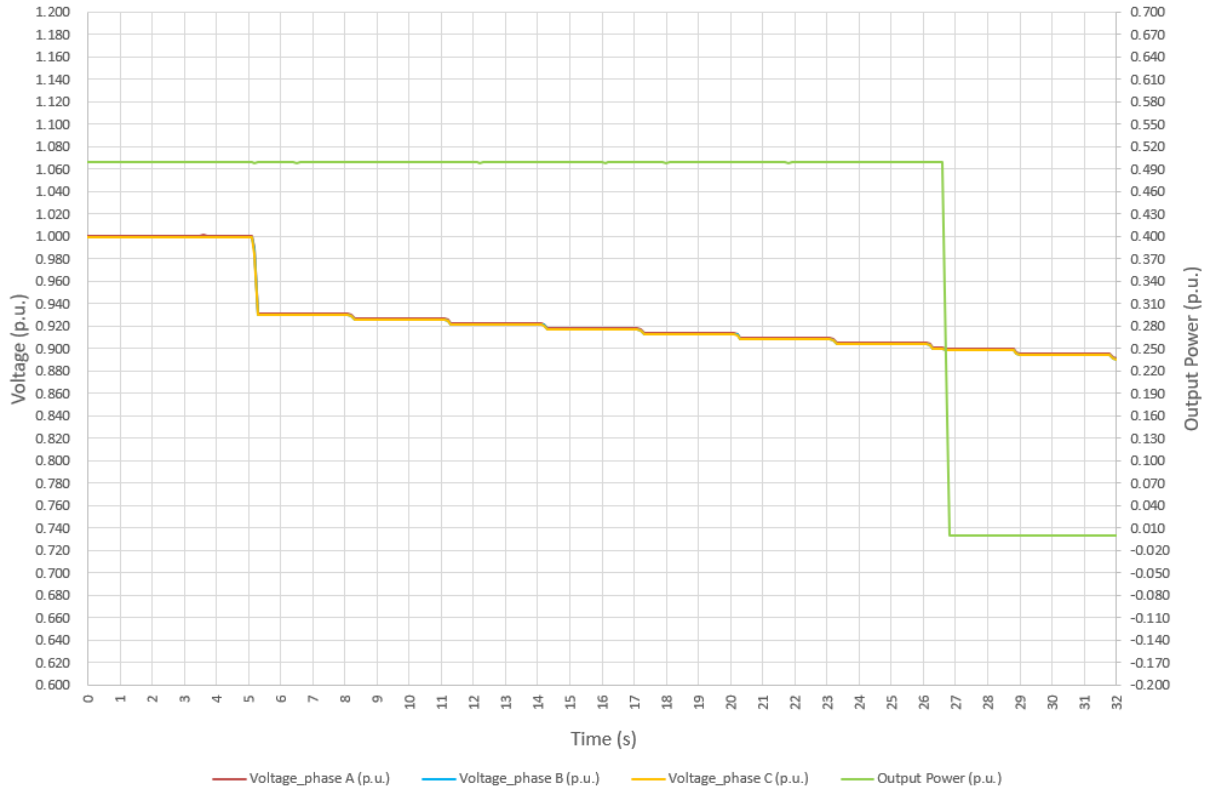

Trip Time

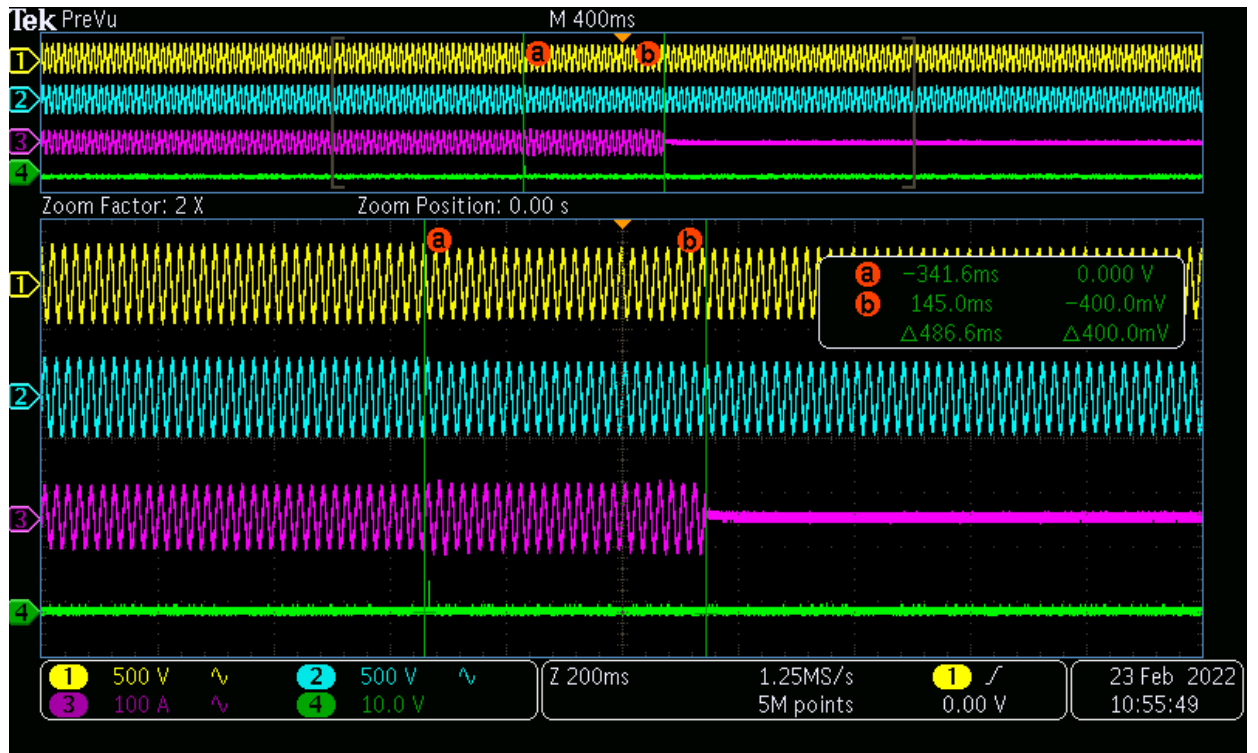

Phase ABC of Test 2

Trip Value

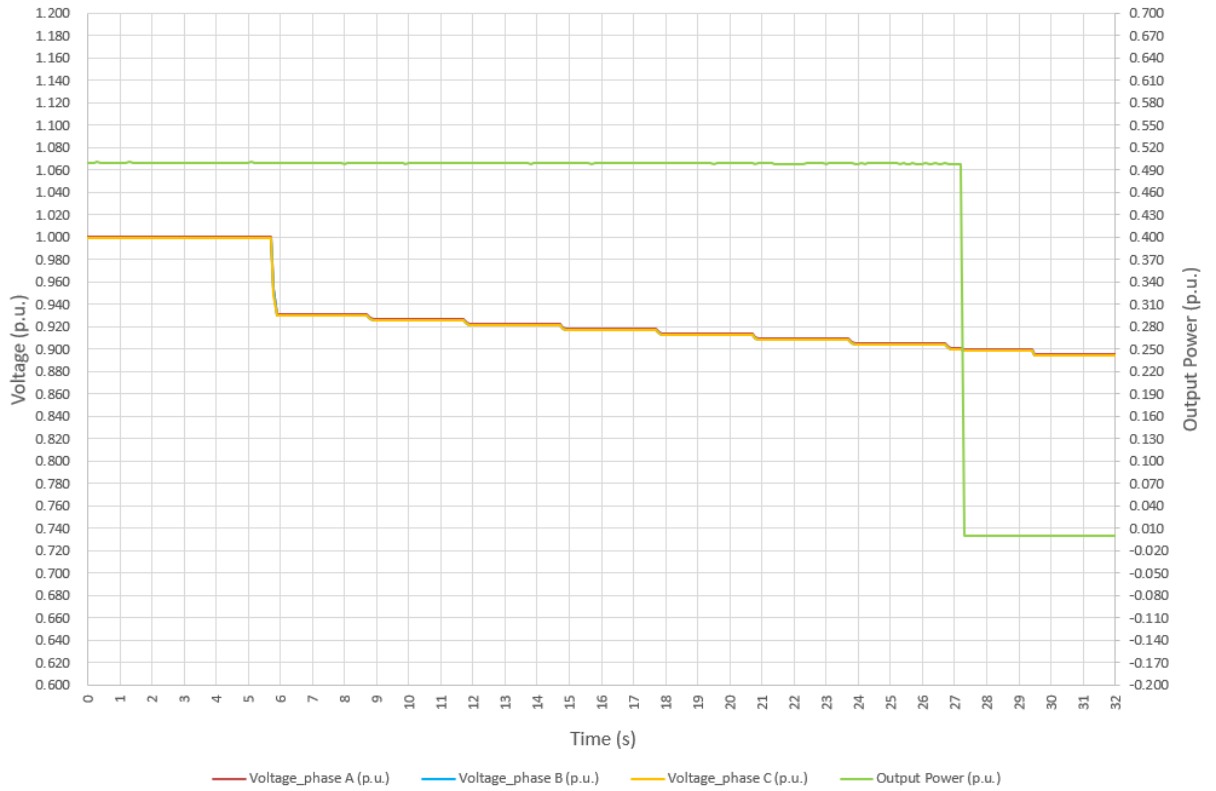

Trip Time

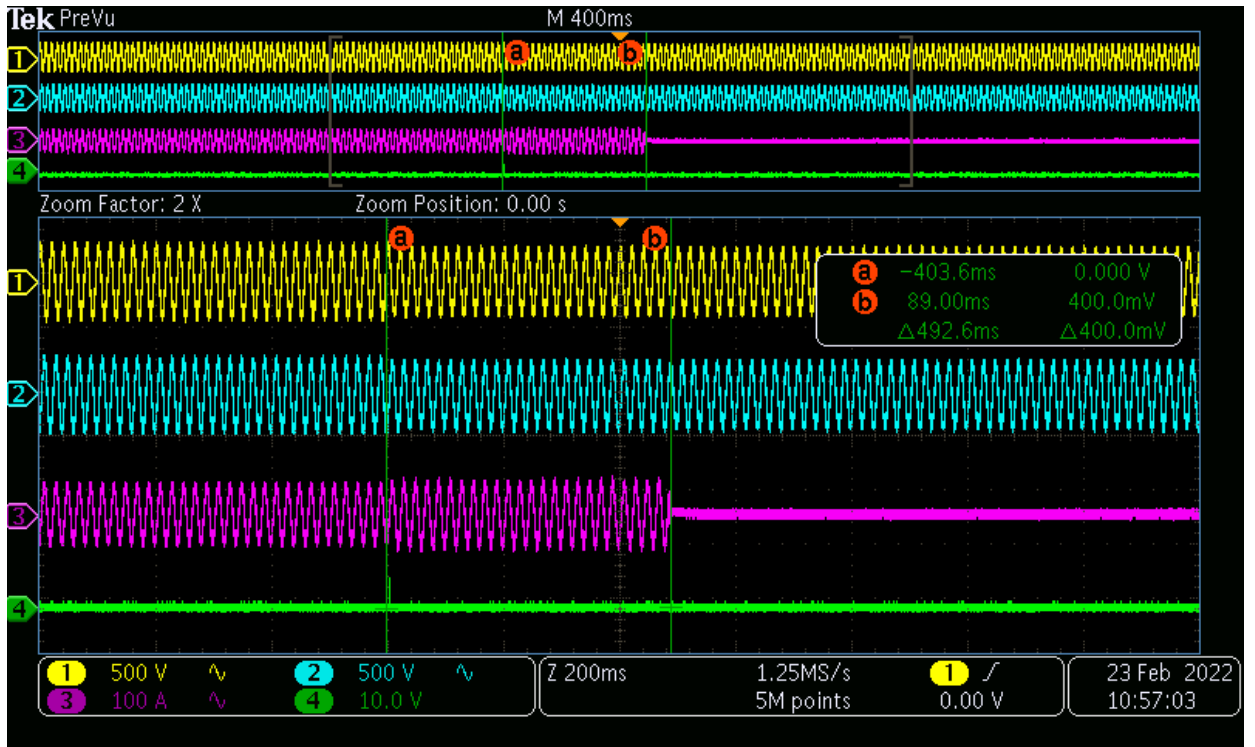

Phase ABC of Test 3

Trip Value

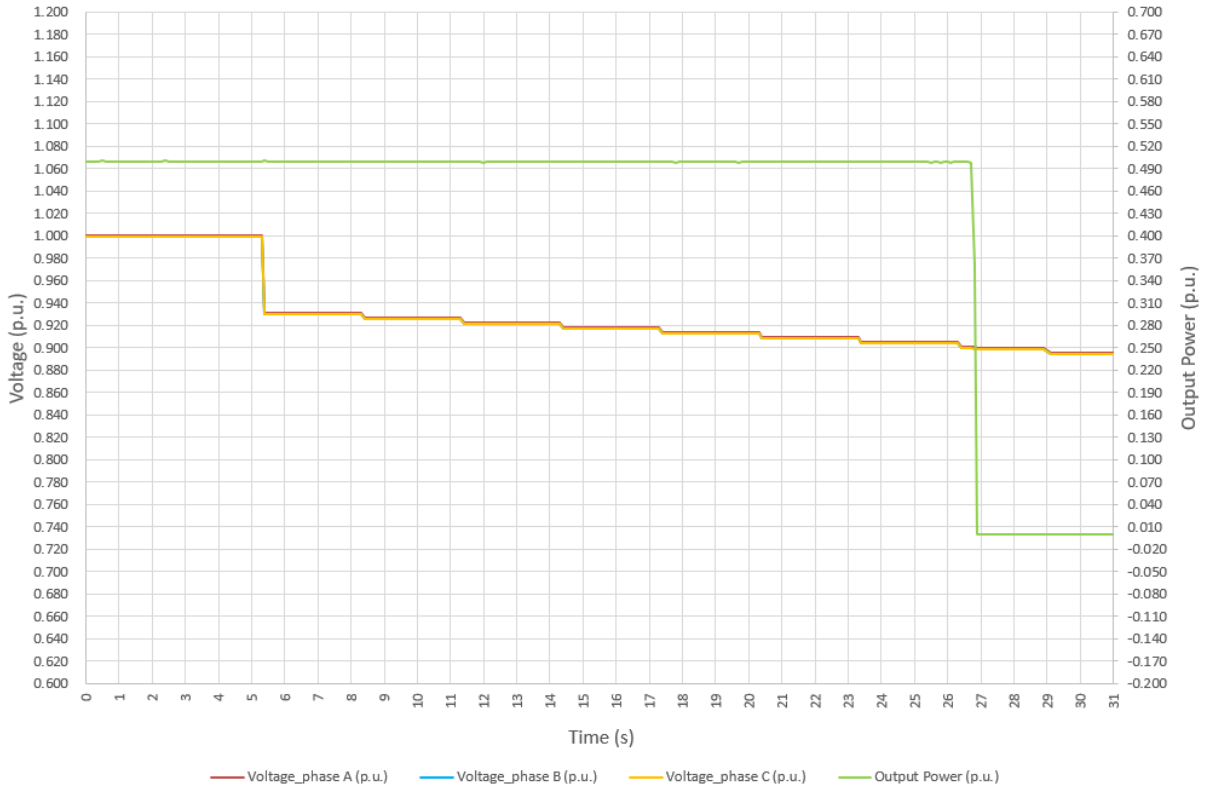

Trip Time

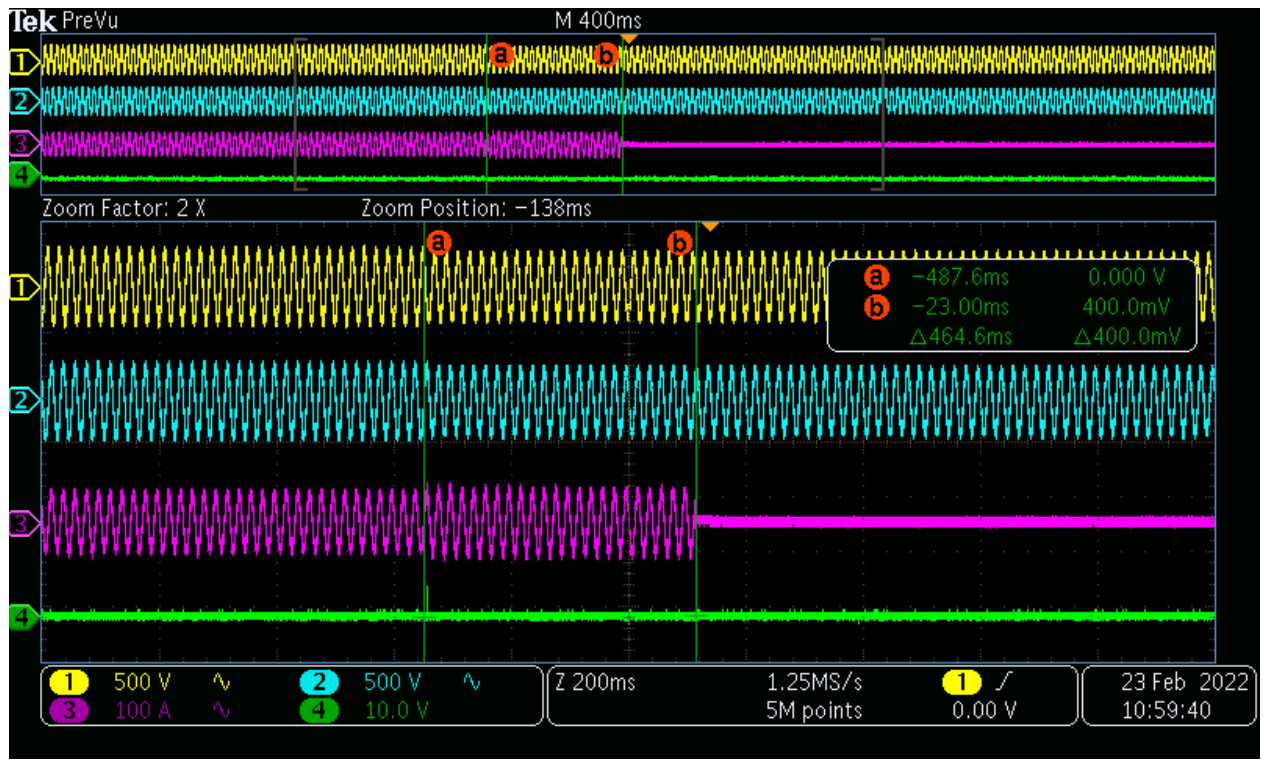

**4.6.2.2 Overvoltage protection (Country / Region: Ireland)**

<b>Overvoltage of 110%Un</b>				
<b>Phase A</b>				
<b>Parameter</b>	<b>Settings</b>	<b>Test 1</b>	<b>Test 2</b>	<b>Test 3</b>
Trip value [V]	253.0	253.2	253.1	253.1
Trip time [s]	< 0.500	0.481	0.492	0.491
<b>Phase B</b>				
<b>Parameter</b>	<b>Settings</b>	<b>Test 1</b>	<b>Test 2</b>	<b>Test 3</b>
Trip value [V]	253.0	252.8	252.8	252.8
Trip time [s]	< 0.500	0.486	0.485	0.481
<b>Phase C</b>				
<b>Parameter</b>	<b>Settings</b>	<b>Test 1</b>	<b>Test 2</b>	<b>Test 3</b>
Trip value [V]	253.0	252.7	252.7	252.7
Trip time [s]	< 0.500	0.484	0.487	0.471
<b>Phase ABC</b>				
<b>Parameter</b>	<b>Settings</b>	<b>Test 1</b>	<b>Test 2</b>	<b>Test 3</b>
Trip value [V]	253.0	253.0	253.0	253.0
Trip time [s]	< 0.500	0.485	0.493	0.491

Test results are represented at diagrams below.

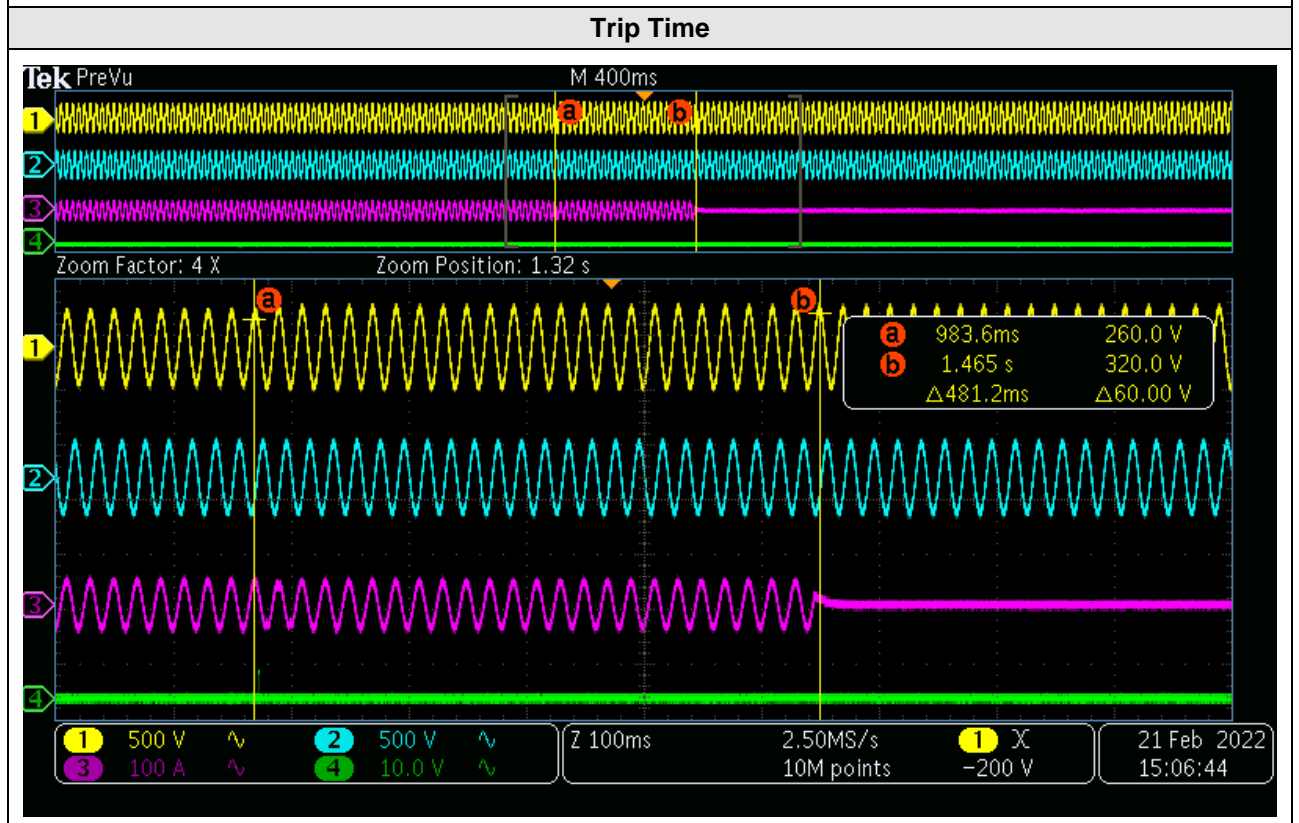
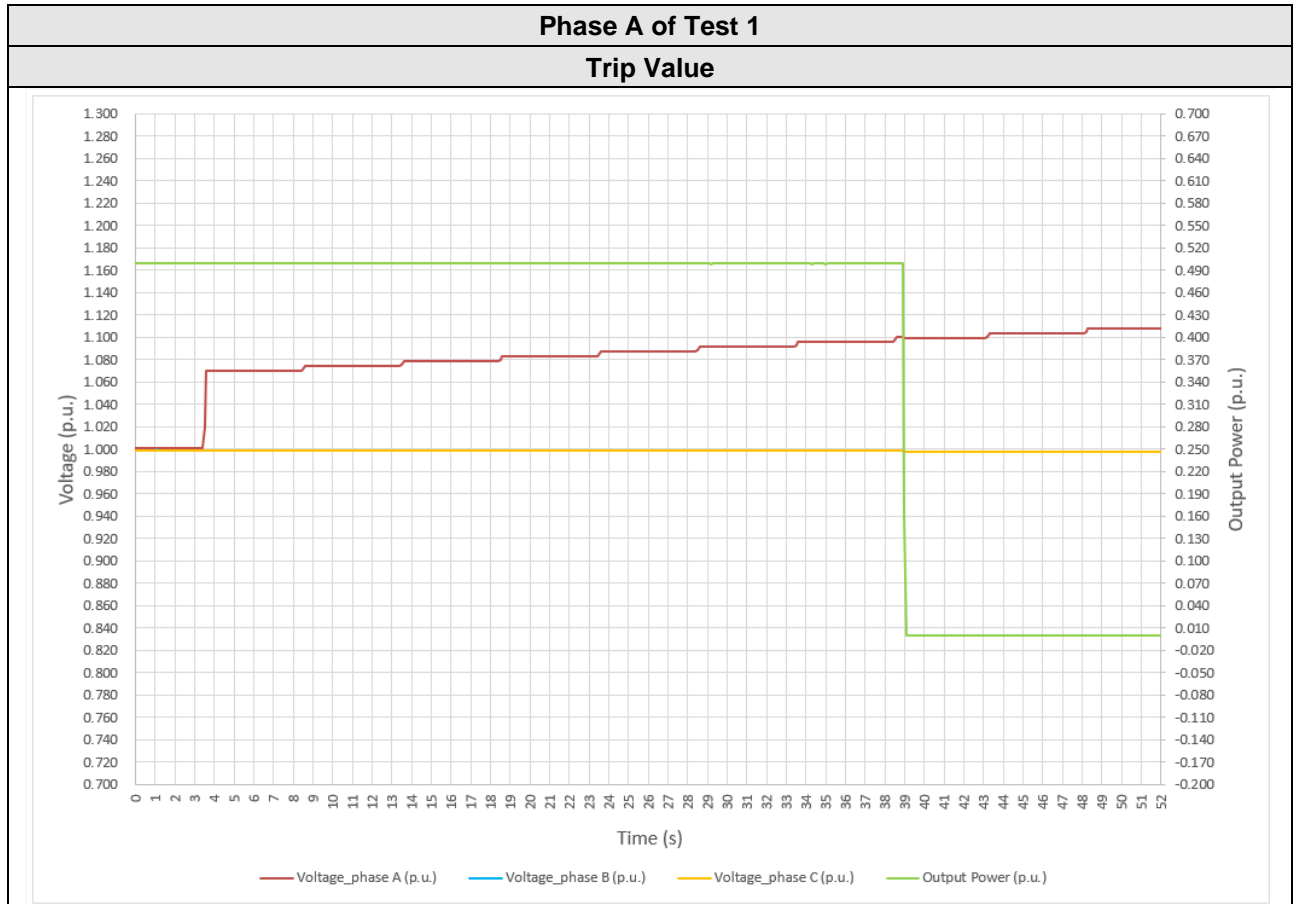

Phase A of Test 2

Trip Value

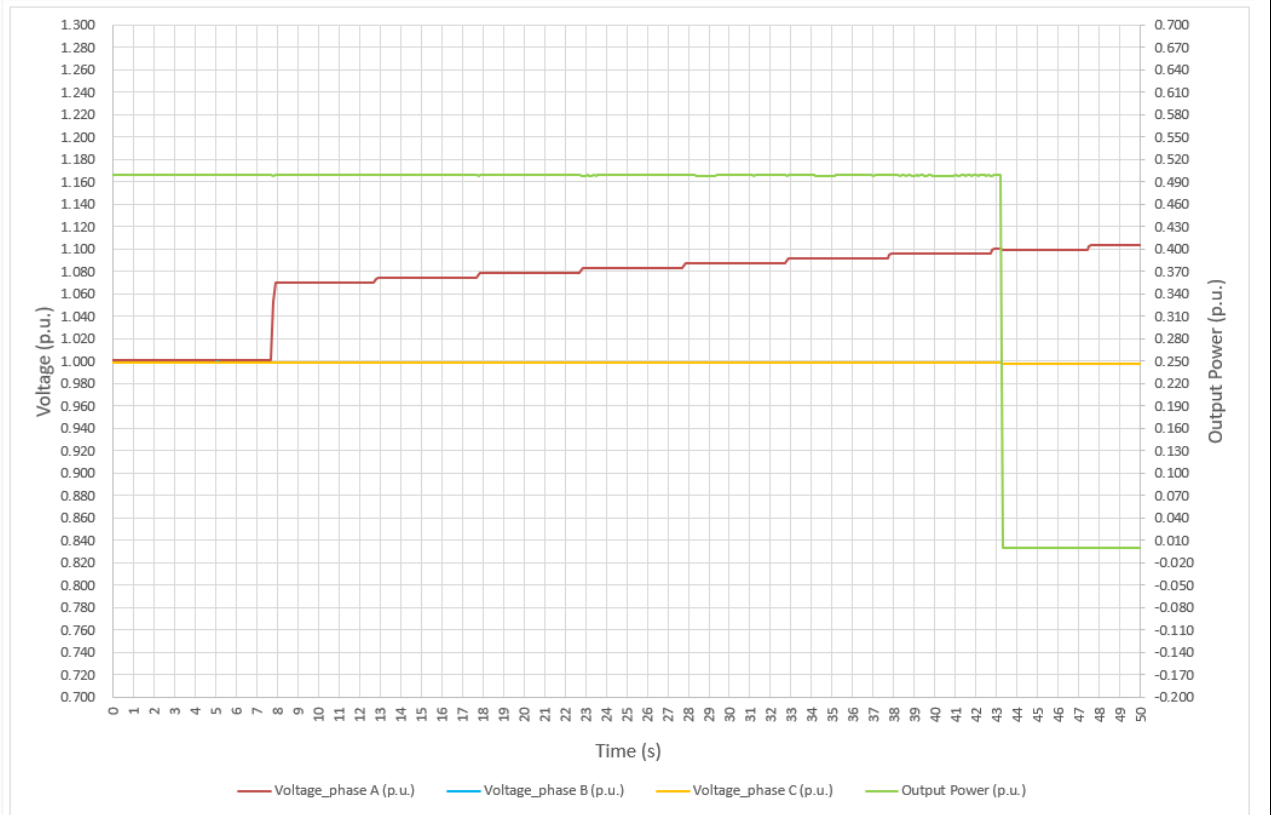

Trip Time

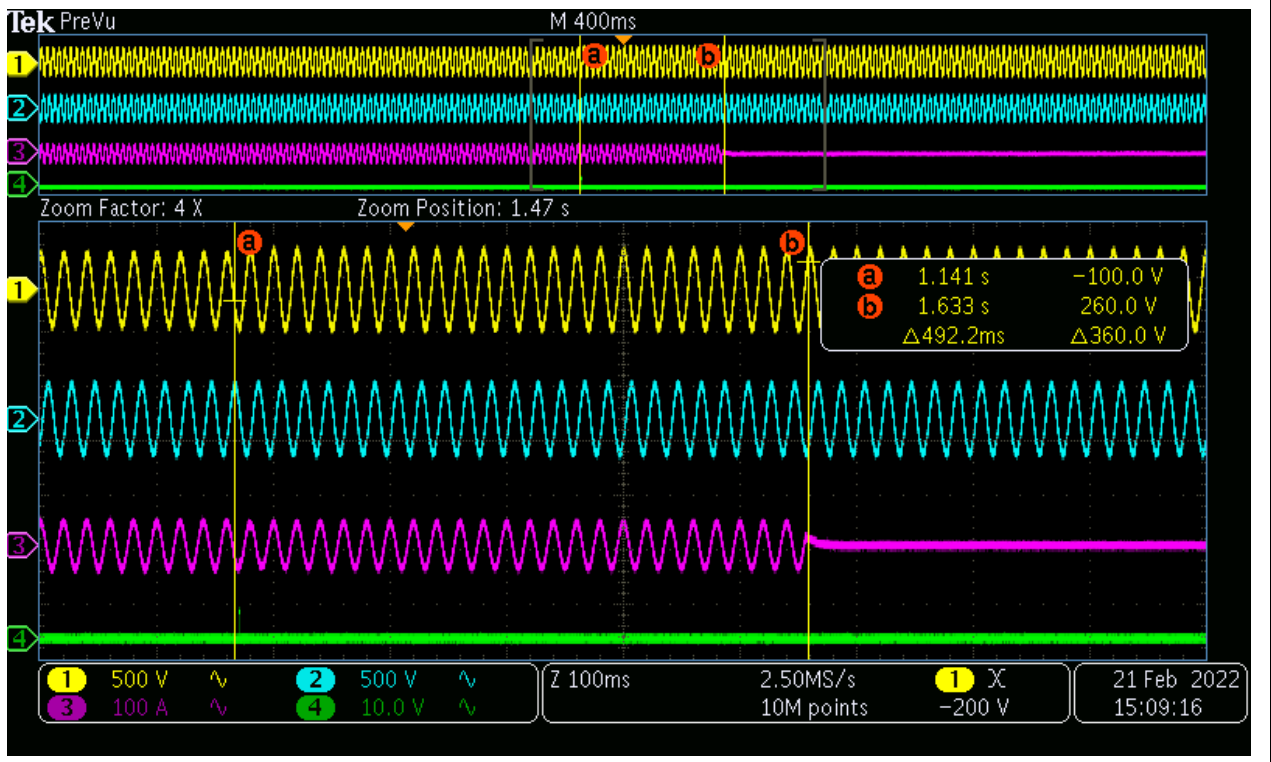

Phase A of Test 3

Trip Value



Trip Time

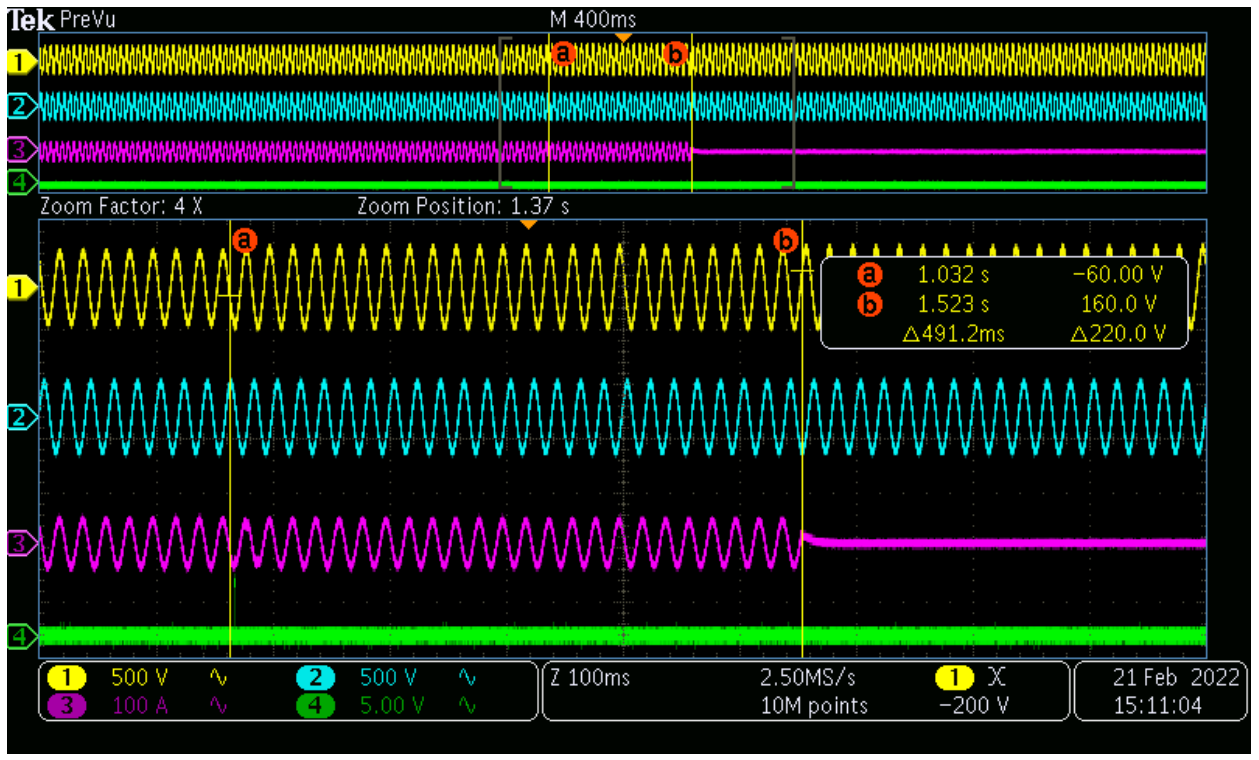



Phase B of Test 1

Trip Value

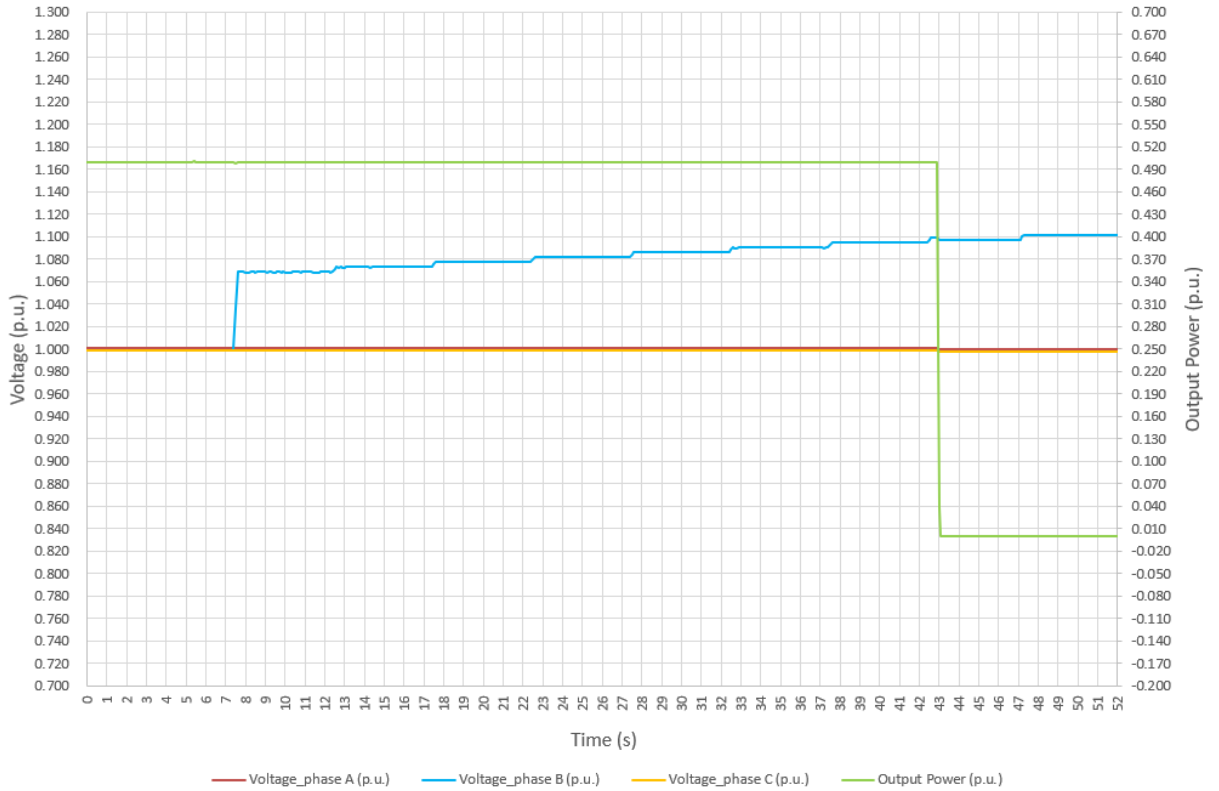

Trip Time

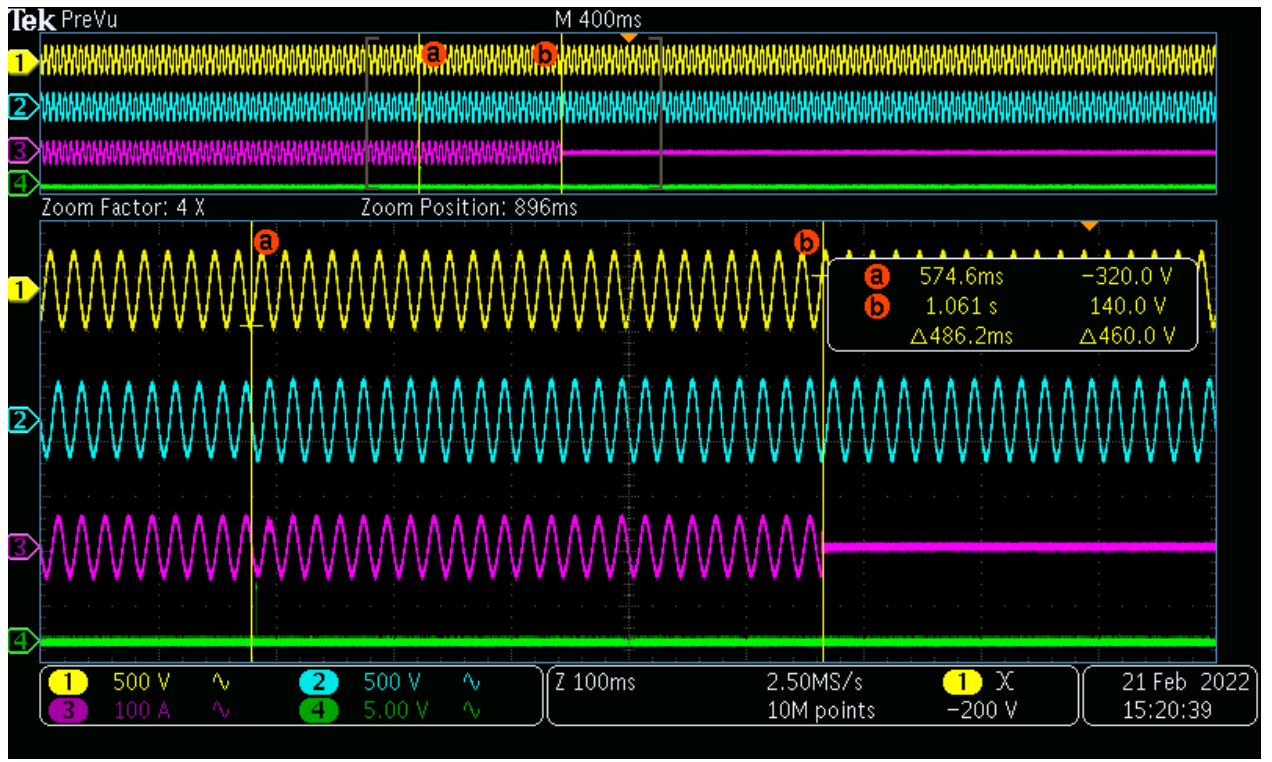

Phase B of Test 2

Trip Value

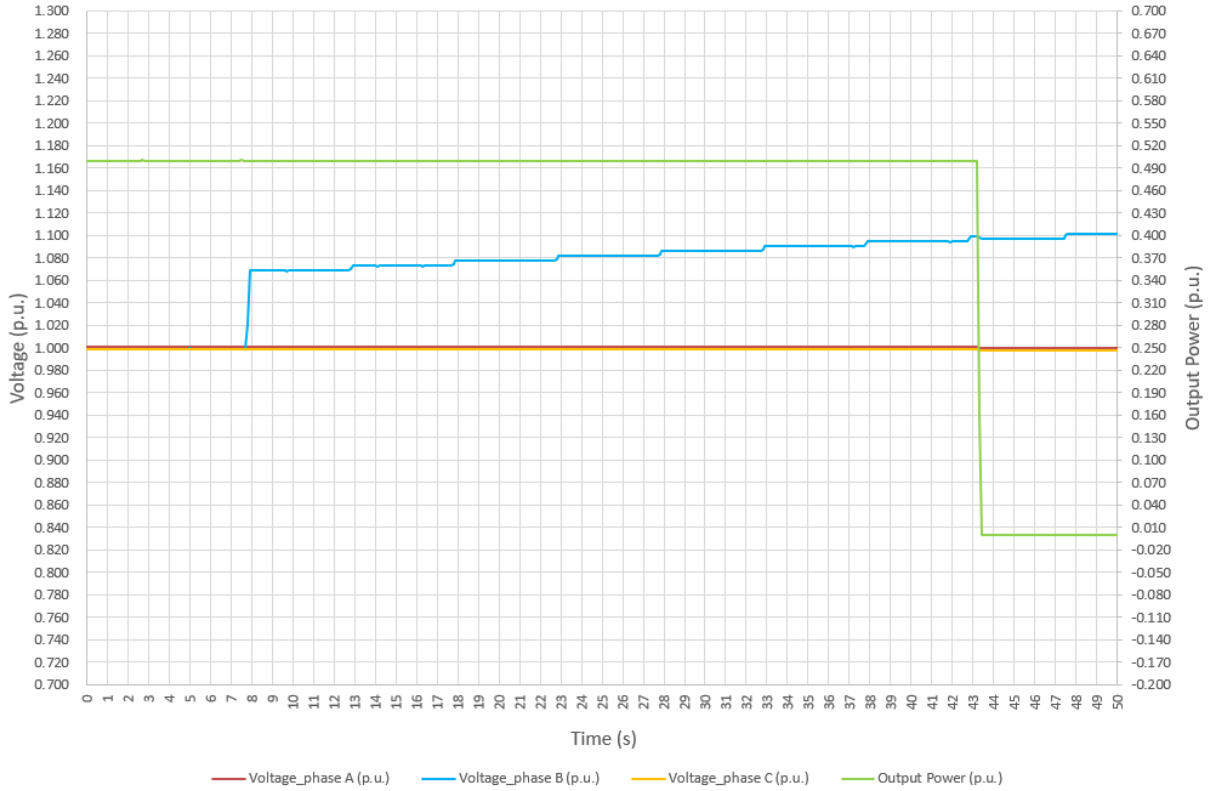

Trip Time

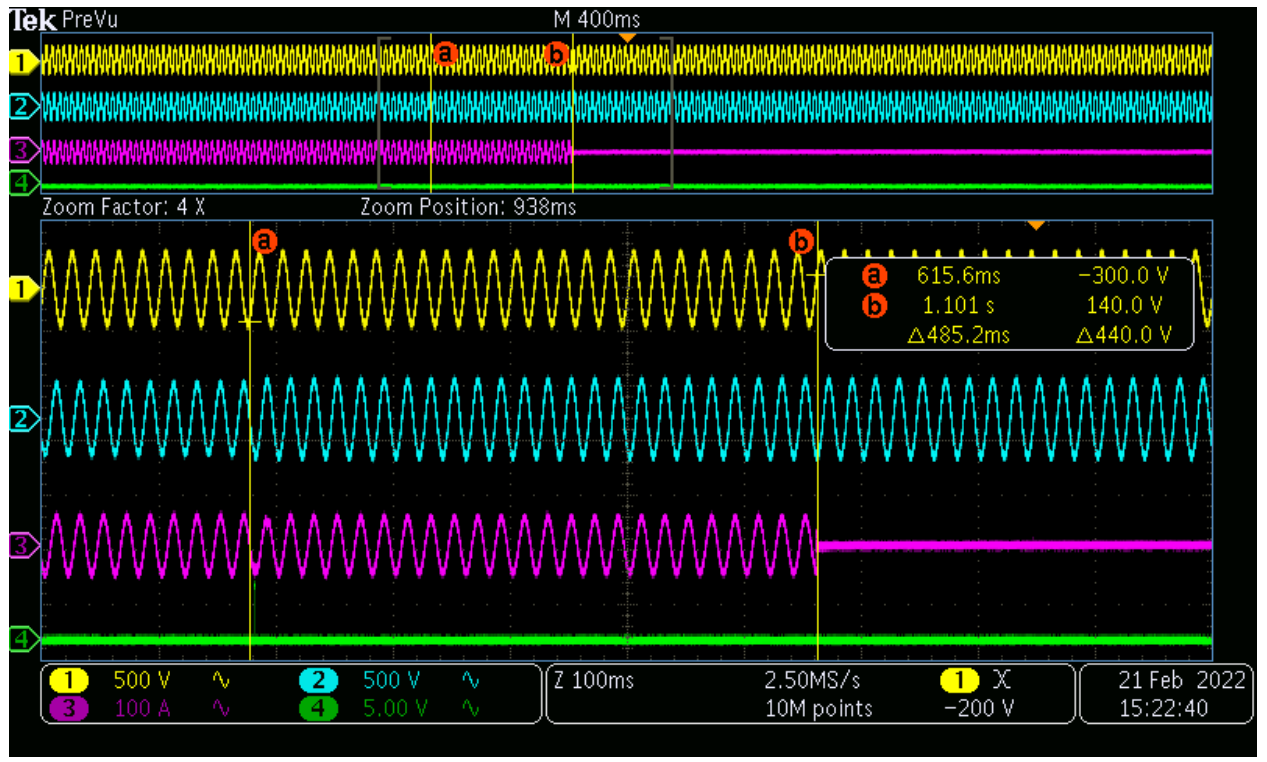

Phase B of Test 3

Trip Value

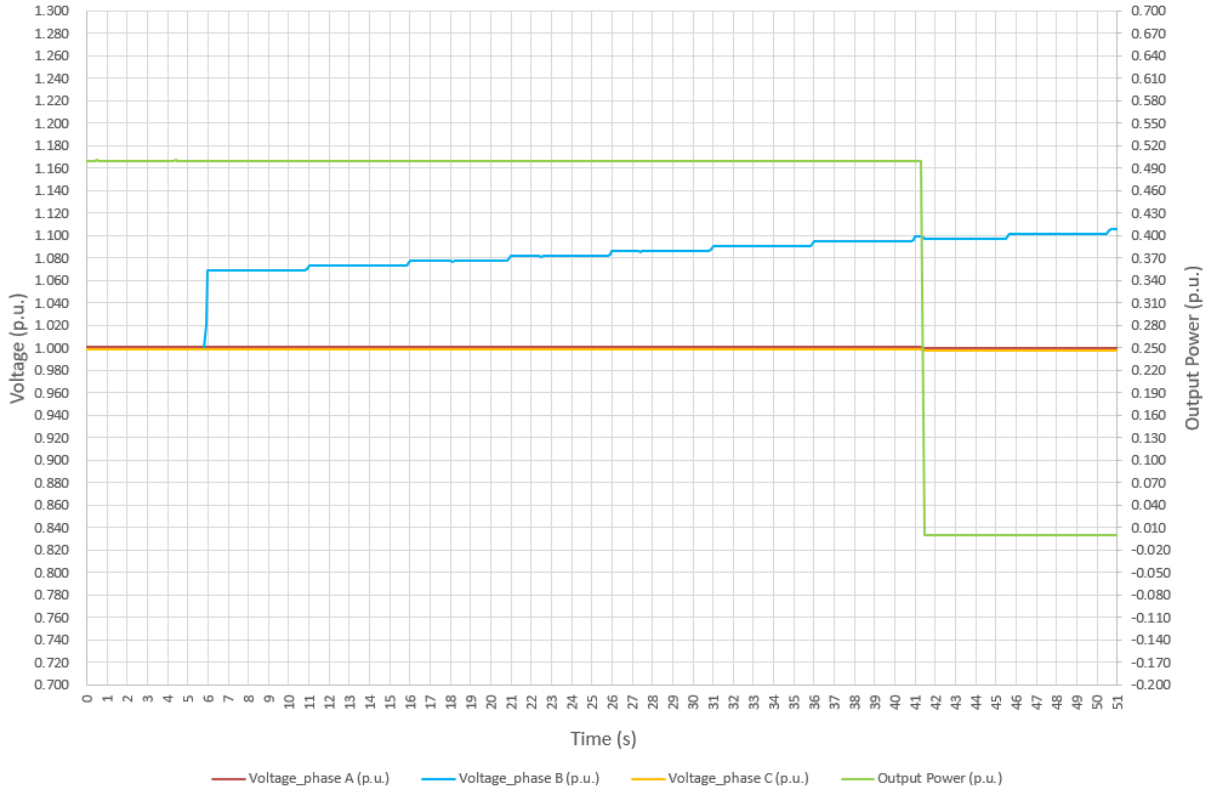

Trip Time

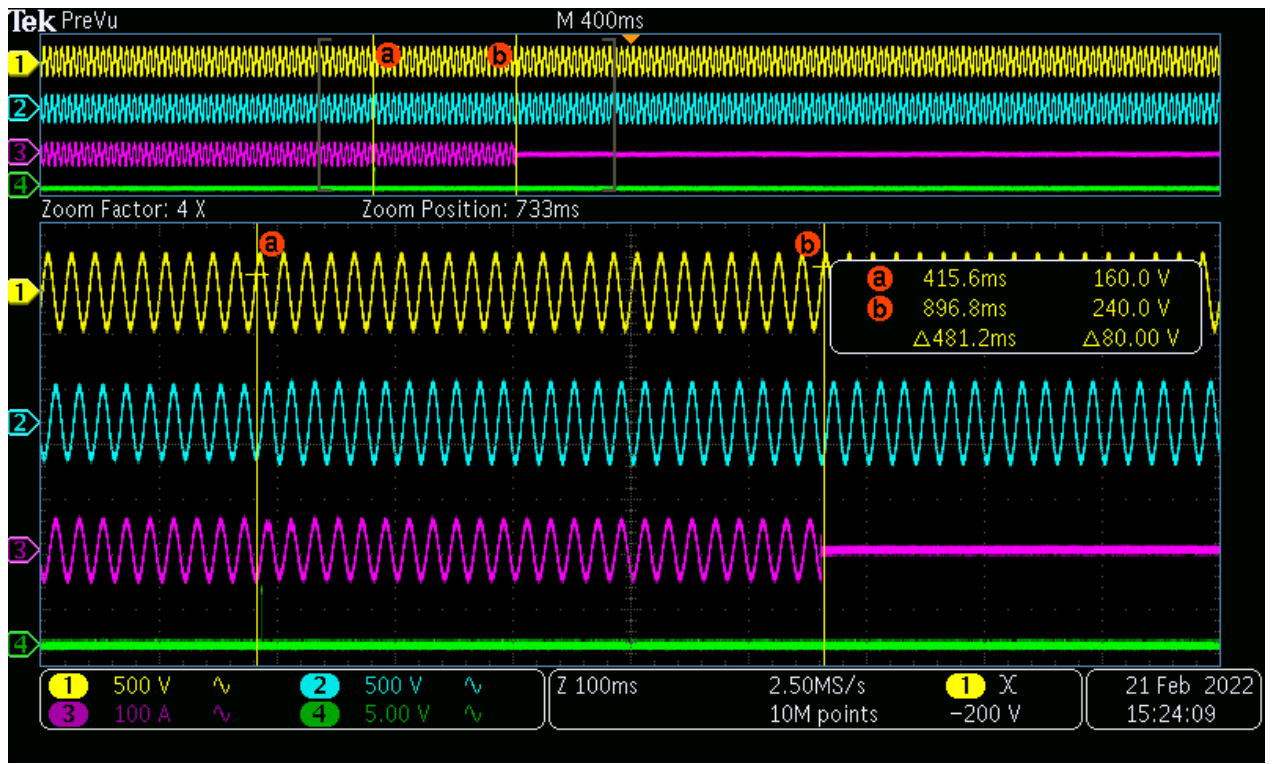

Phase C of Test 1

Trip Value

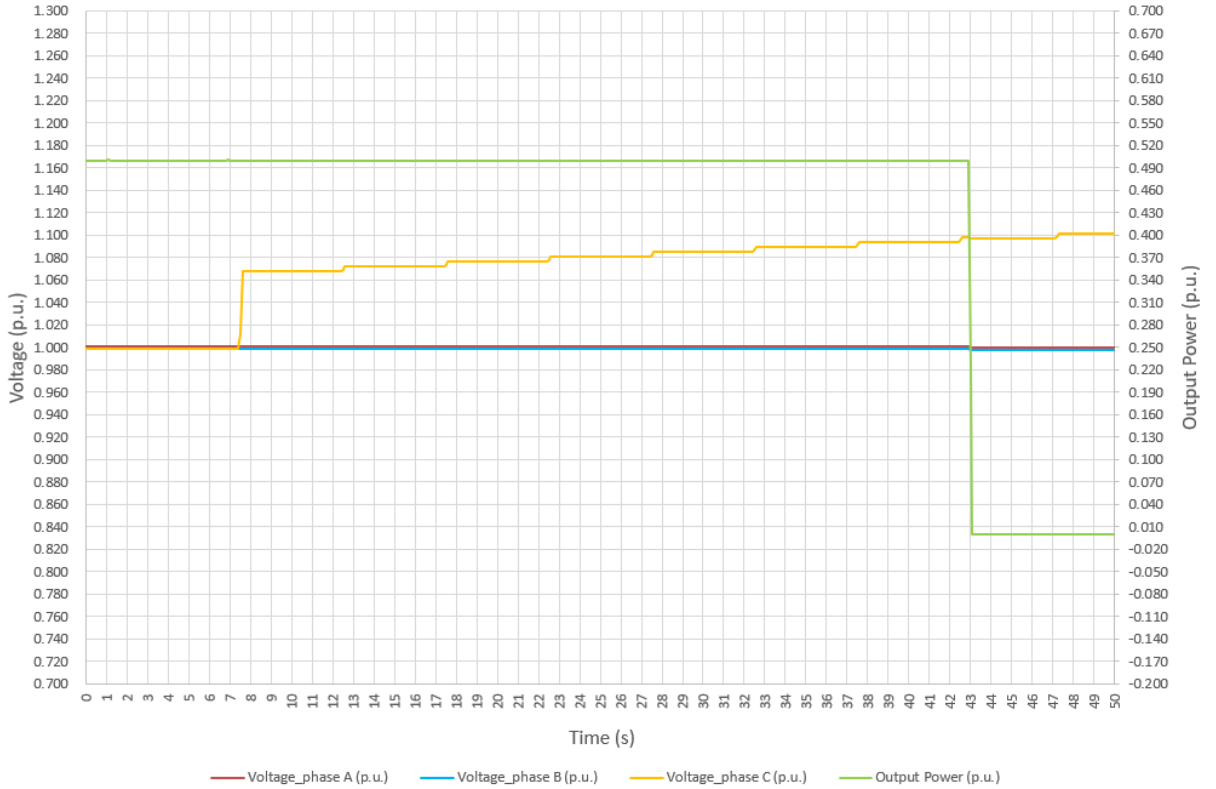

Trip Time

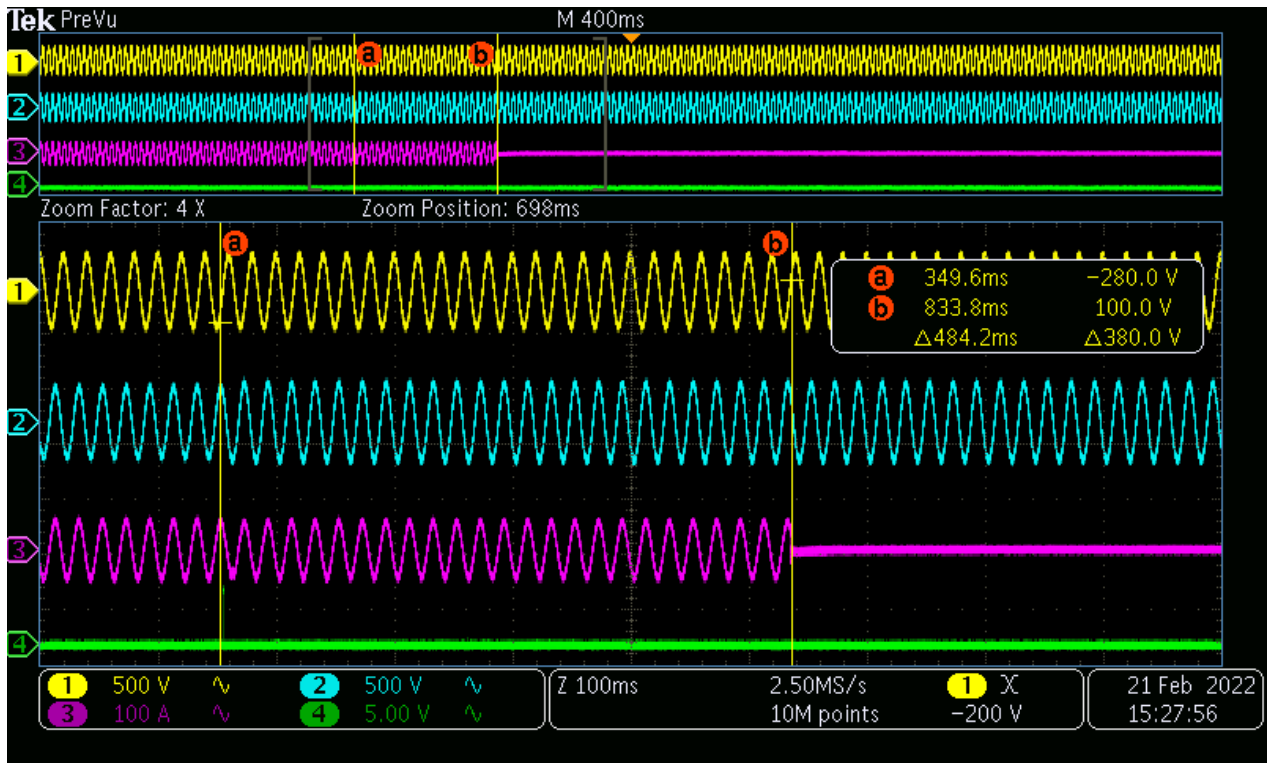

Phase C of Test 2

Trip Value

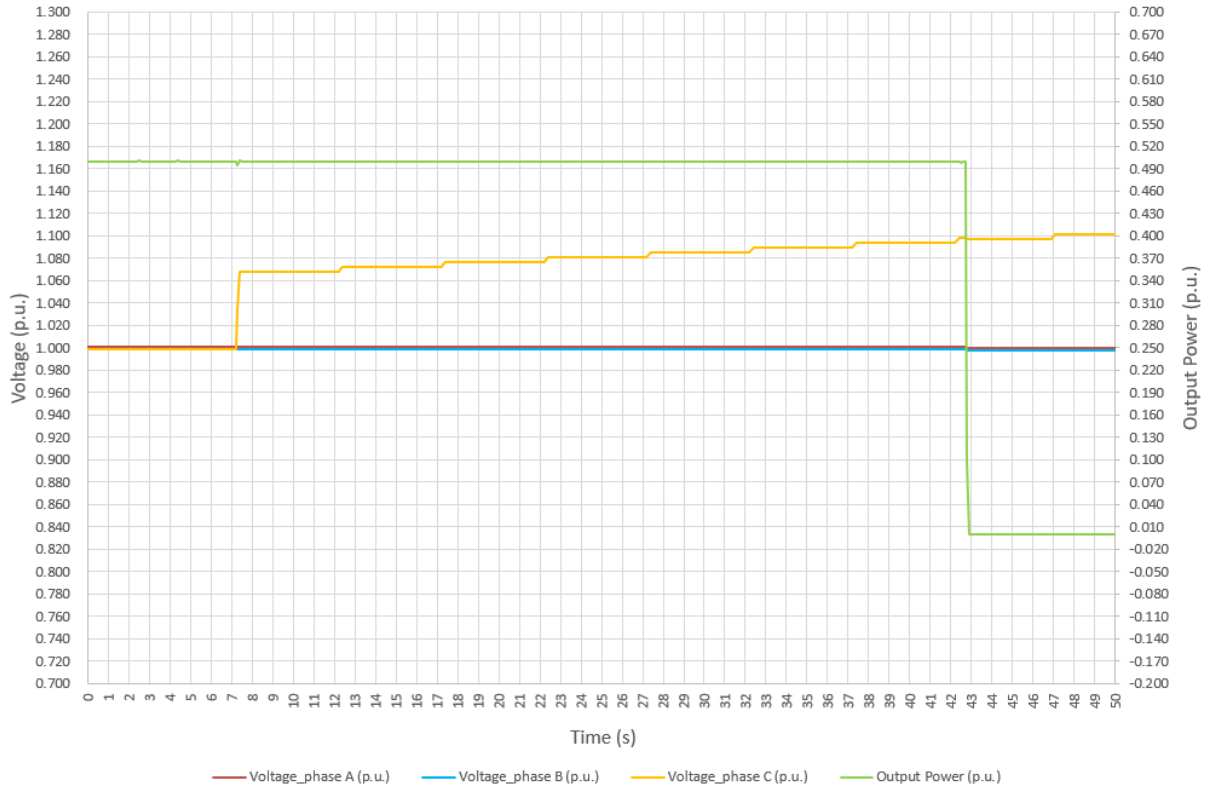

Trip Time

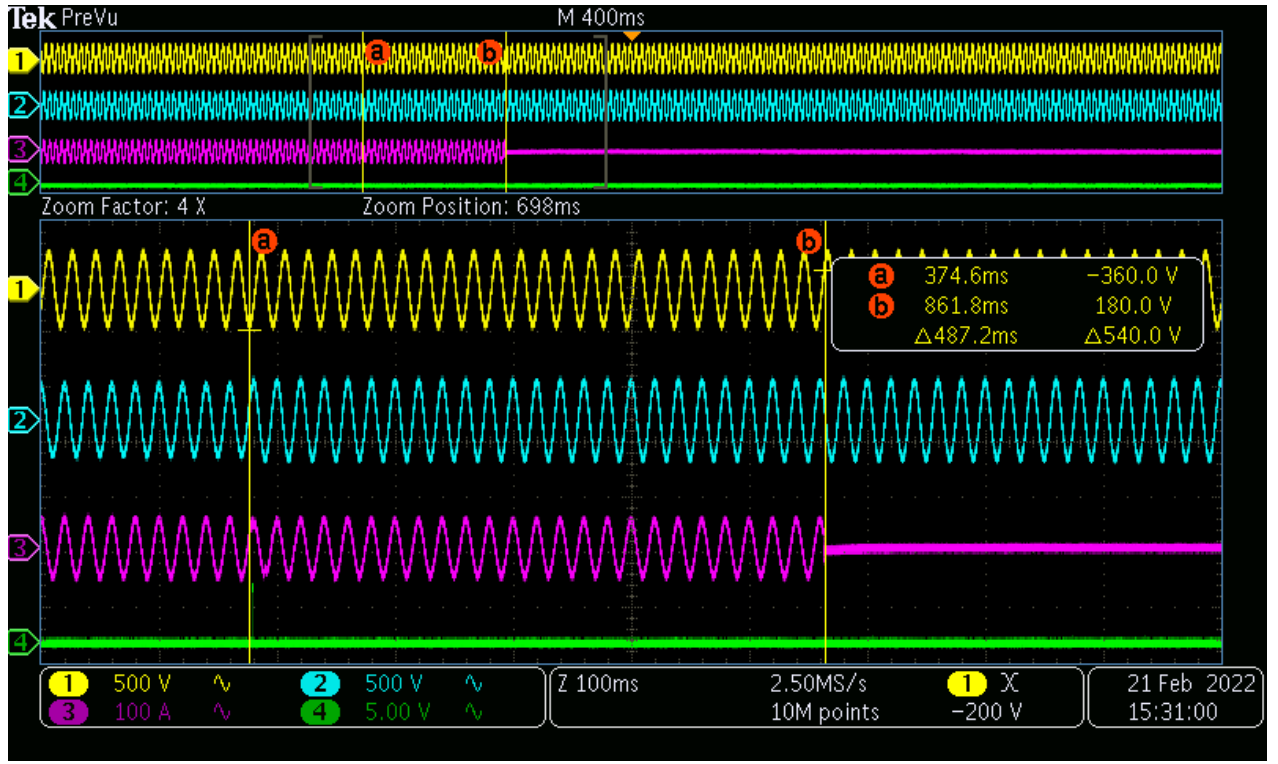

Phase C of Test 3

Trip Value



Trip Time

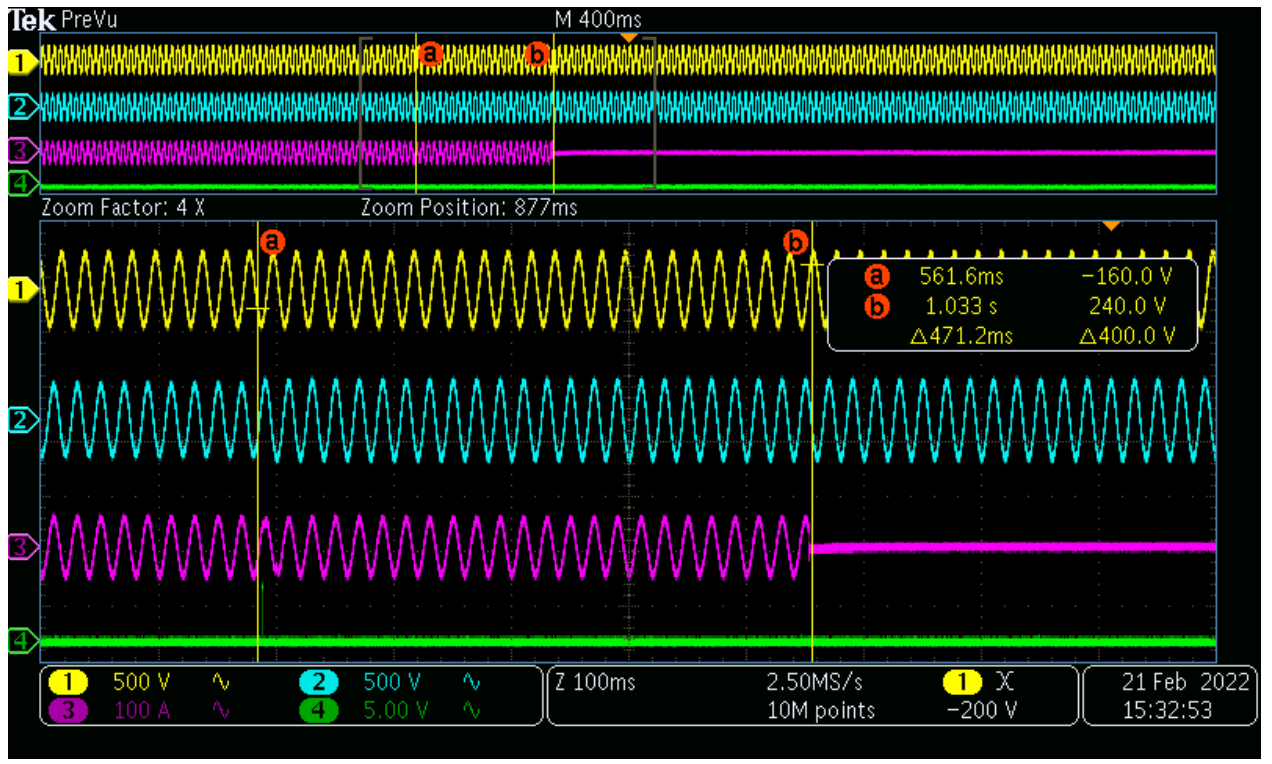

Phase ABC of Test 1

Trip Value

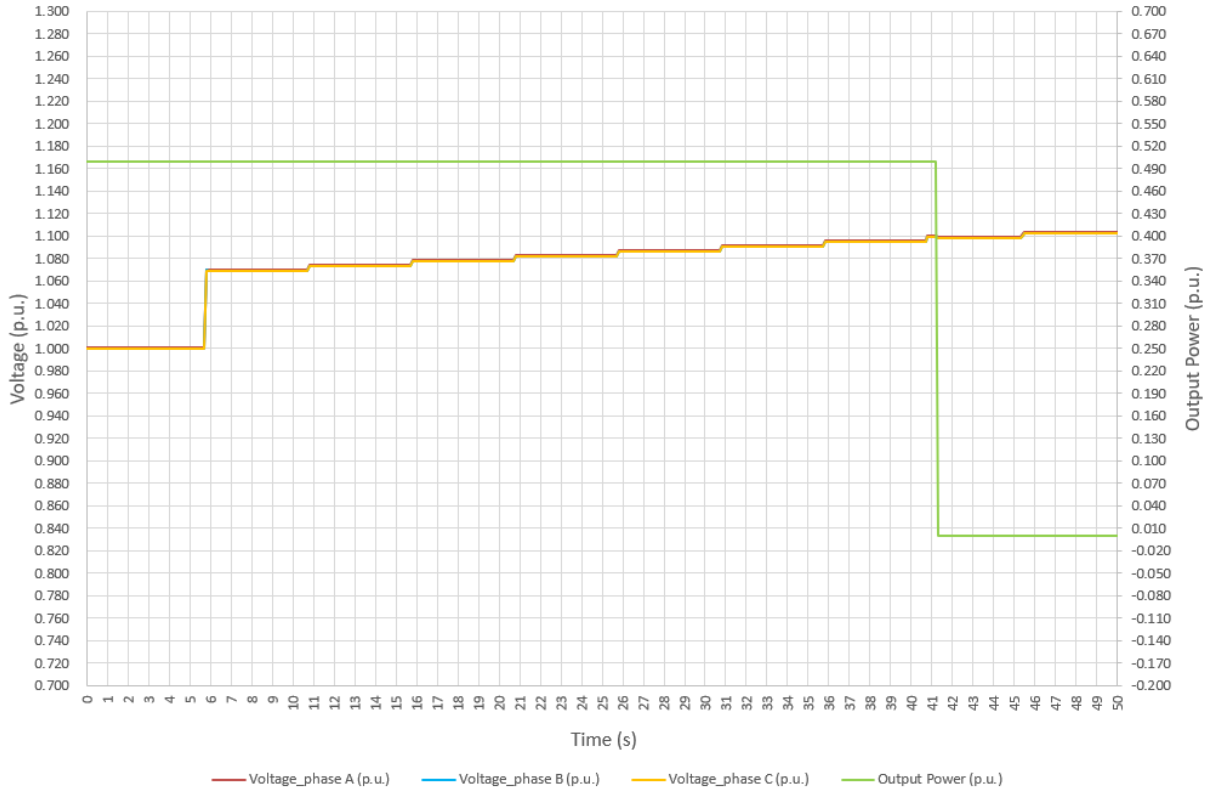

Trip Time

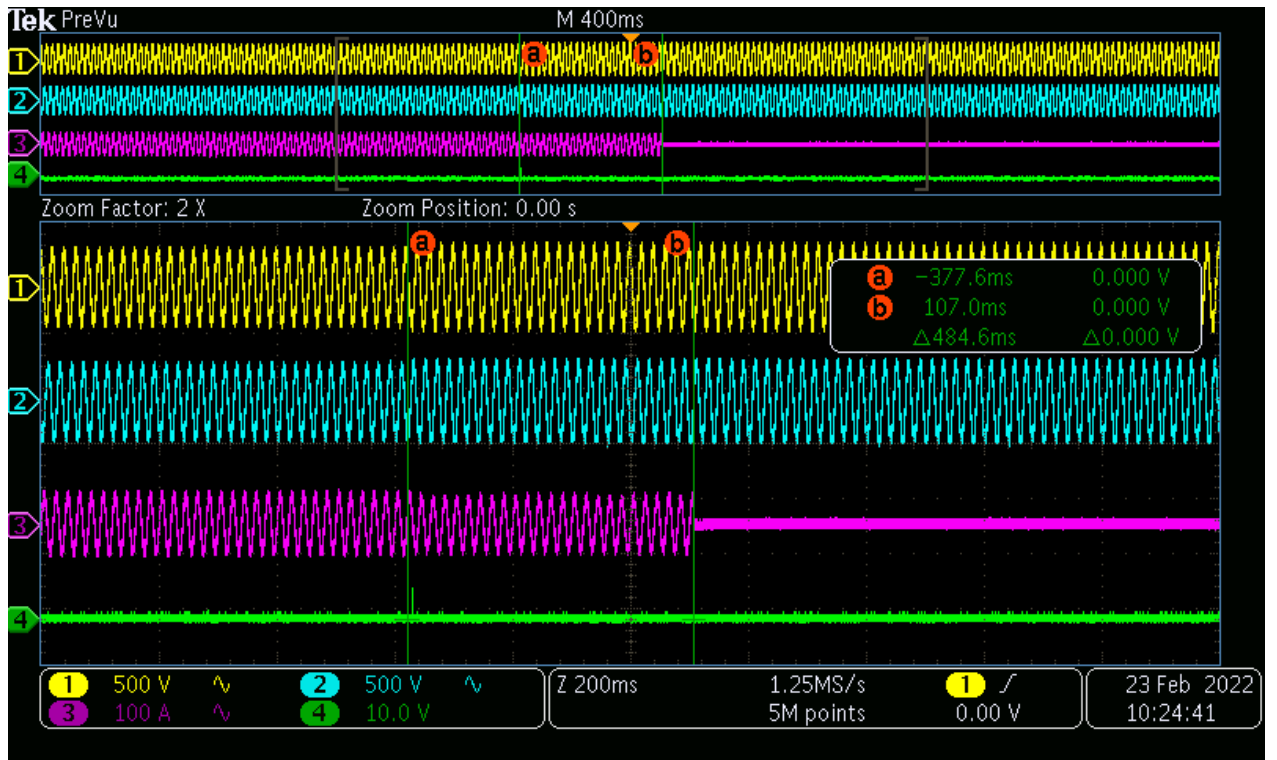

Phase ABC of Test 2

Trip Value

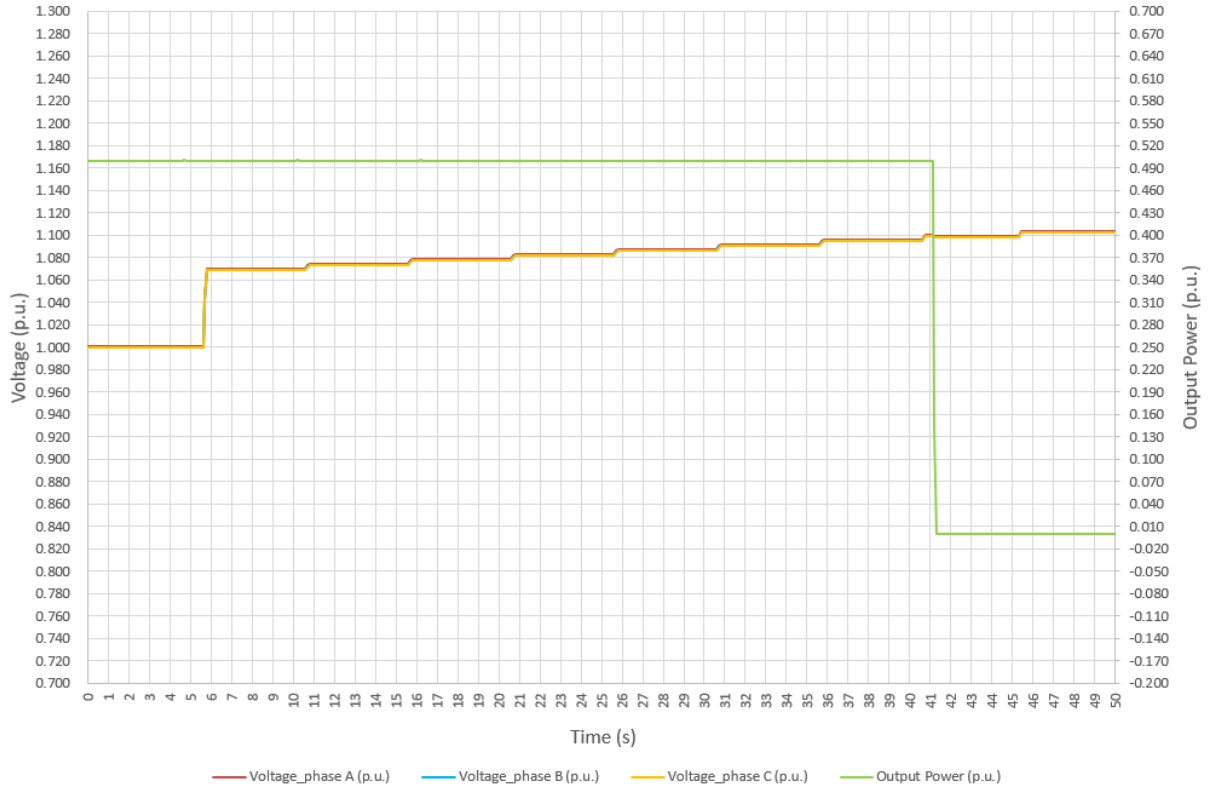

Trip Time

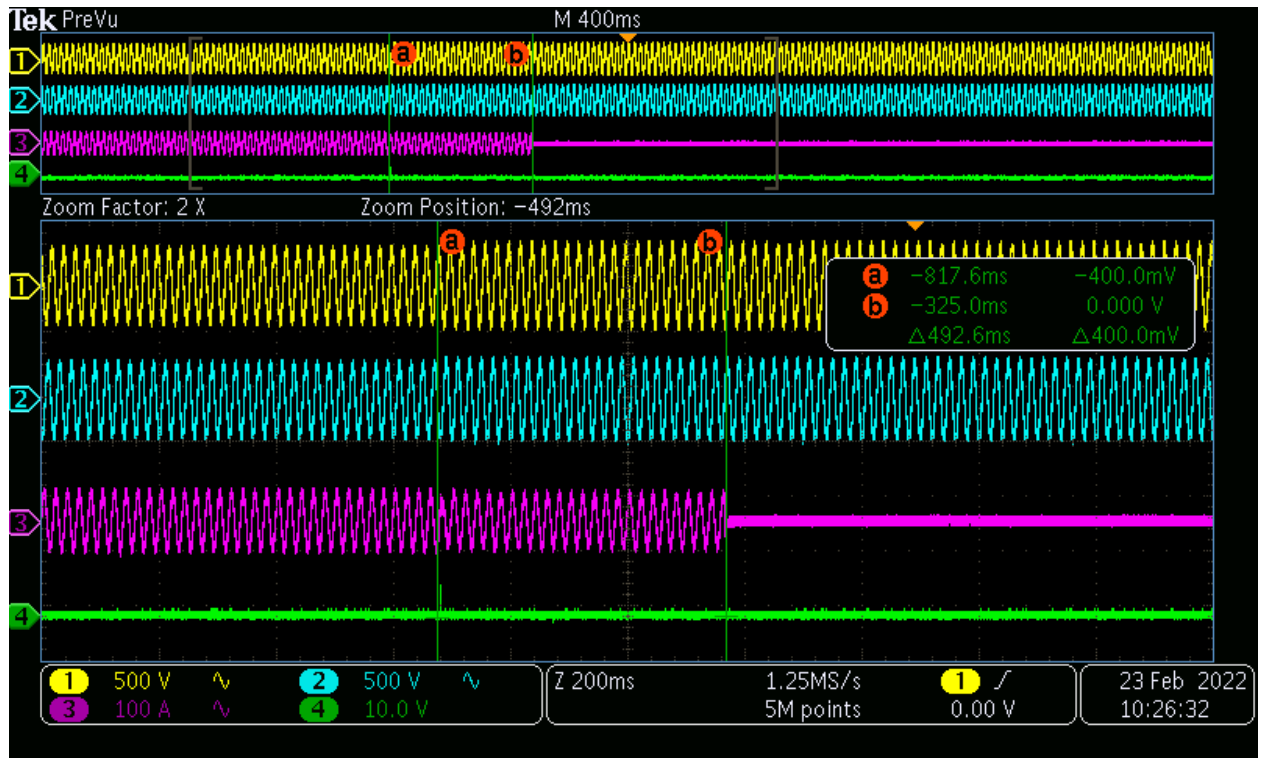



Phase ABC of Test 3

Trip Value

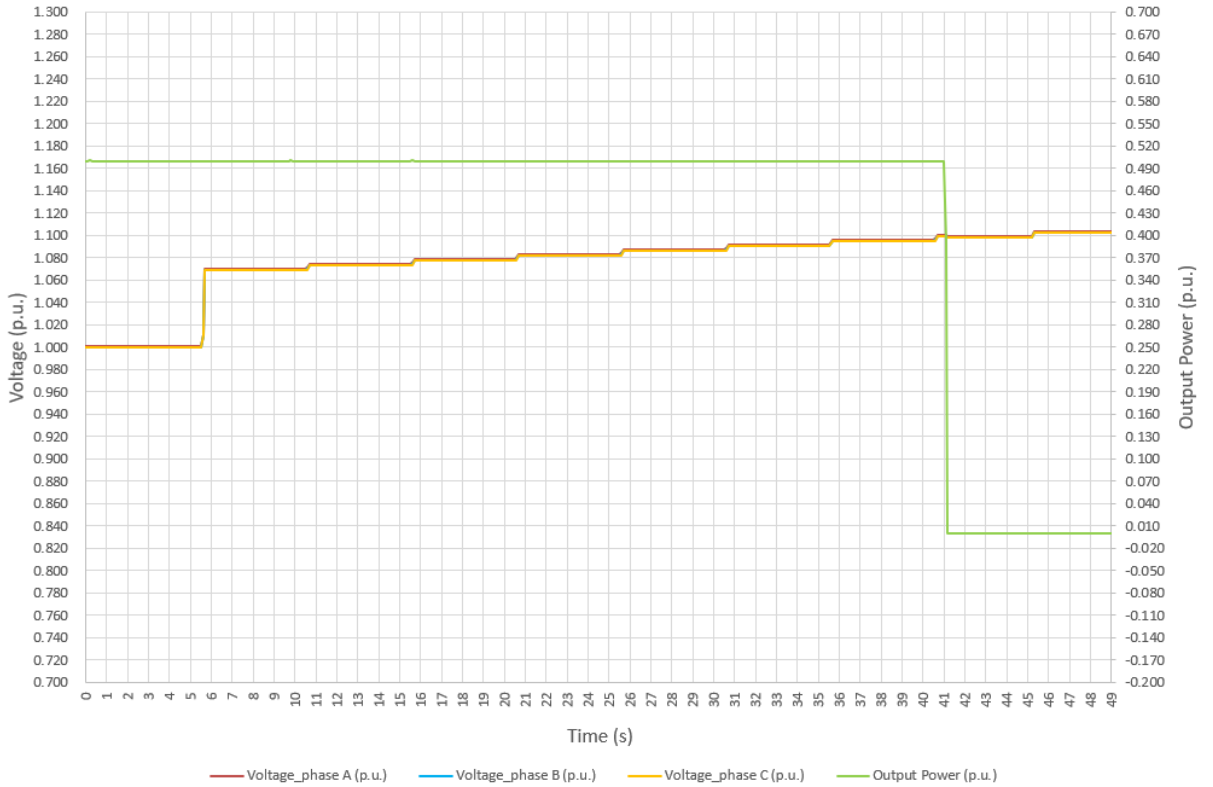

Trip Time

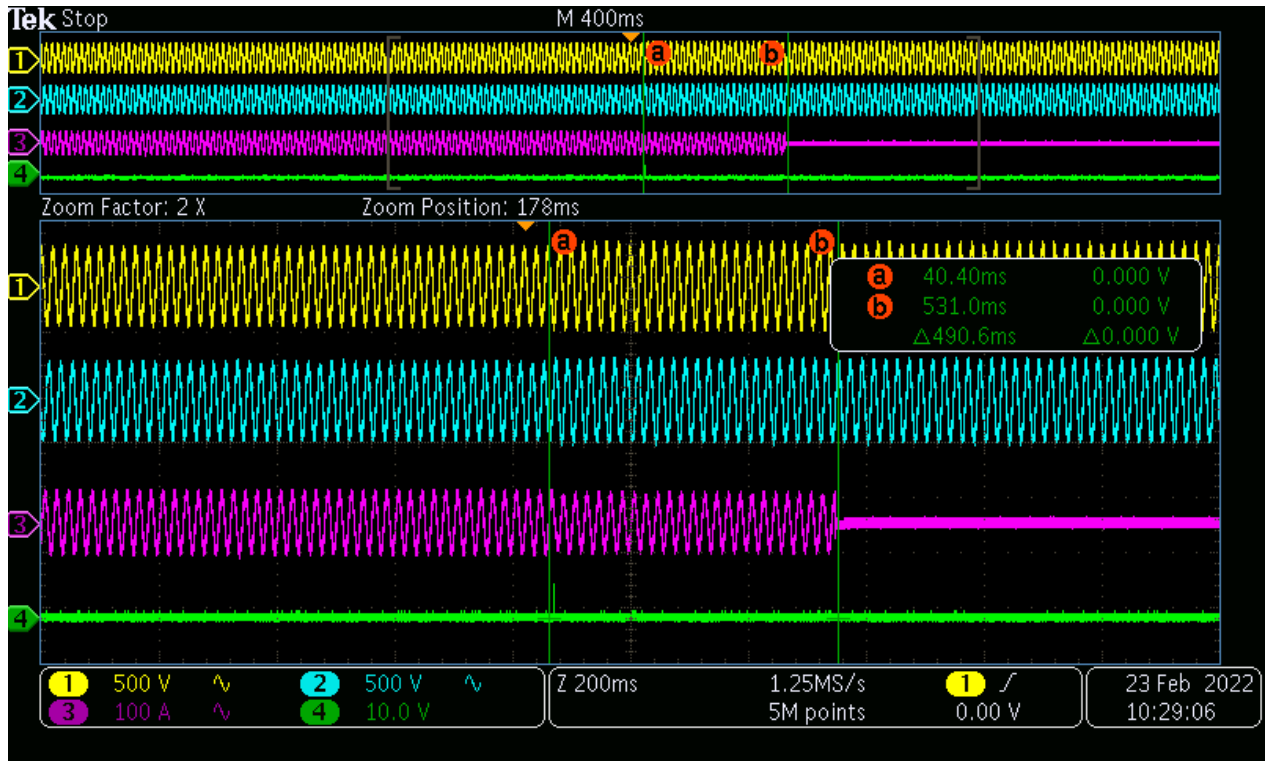

**4.6.2.3 Underfrequency protection (Country / Region: Ireland)**

50Hz - 4%				
Parameter	Settings	Test 1	Test 2	Test 3
Trip value [Hz]	48.00	47.99	47.99	47.97
Trip time [s]	< 0.500	0.459	0.457	0.451

Test results are represented at diagrams below.

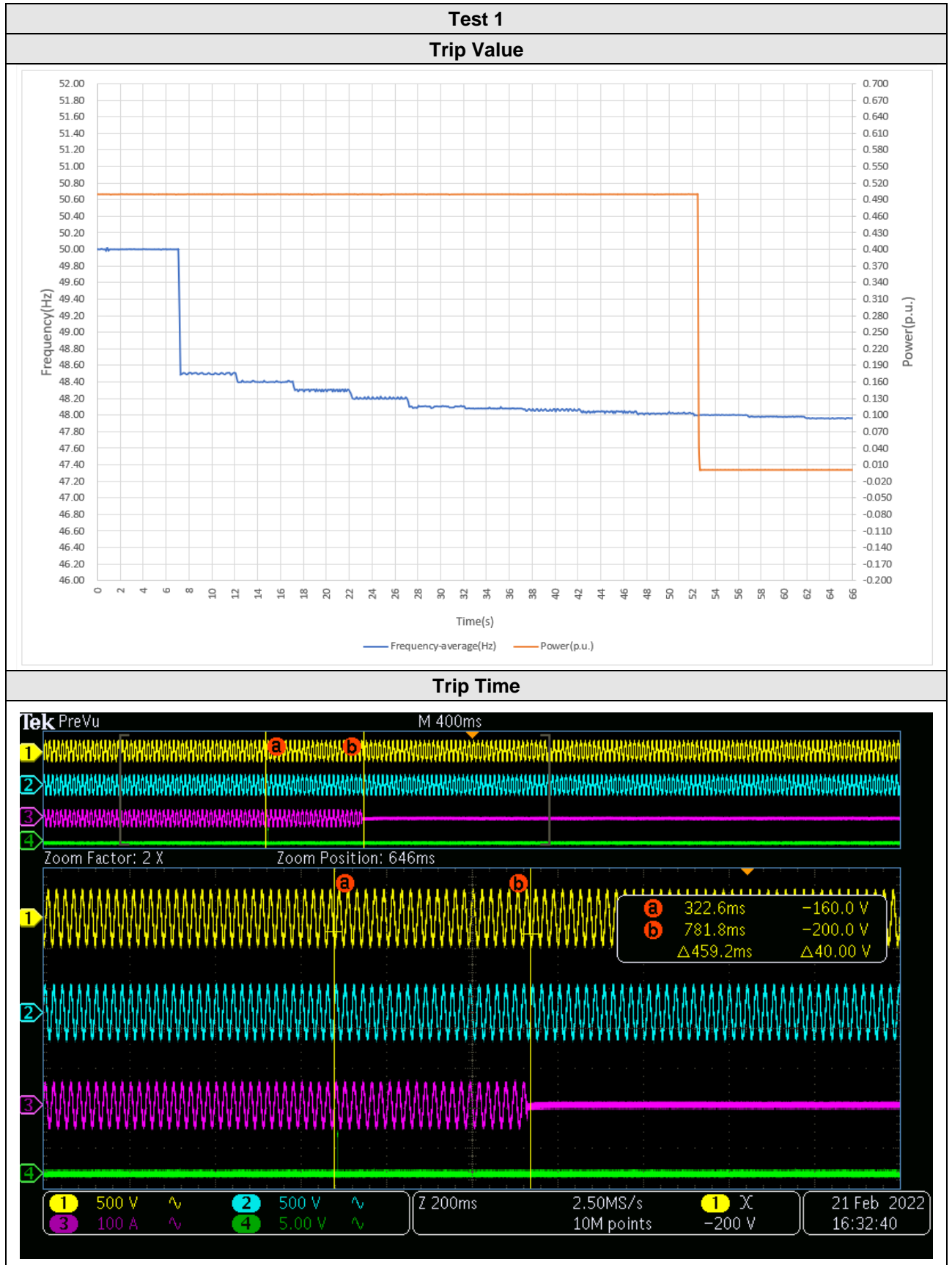

Test 2

Trip Value

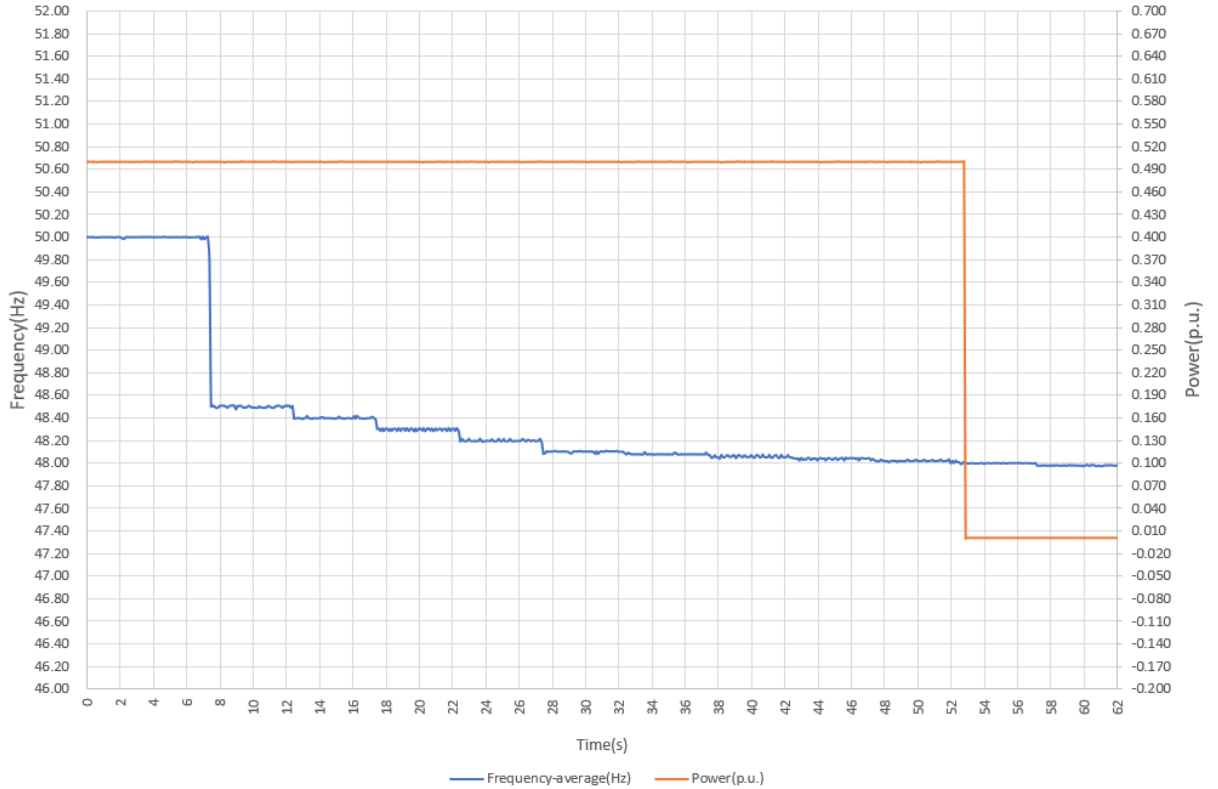

Trip Time

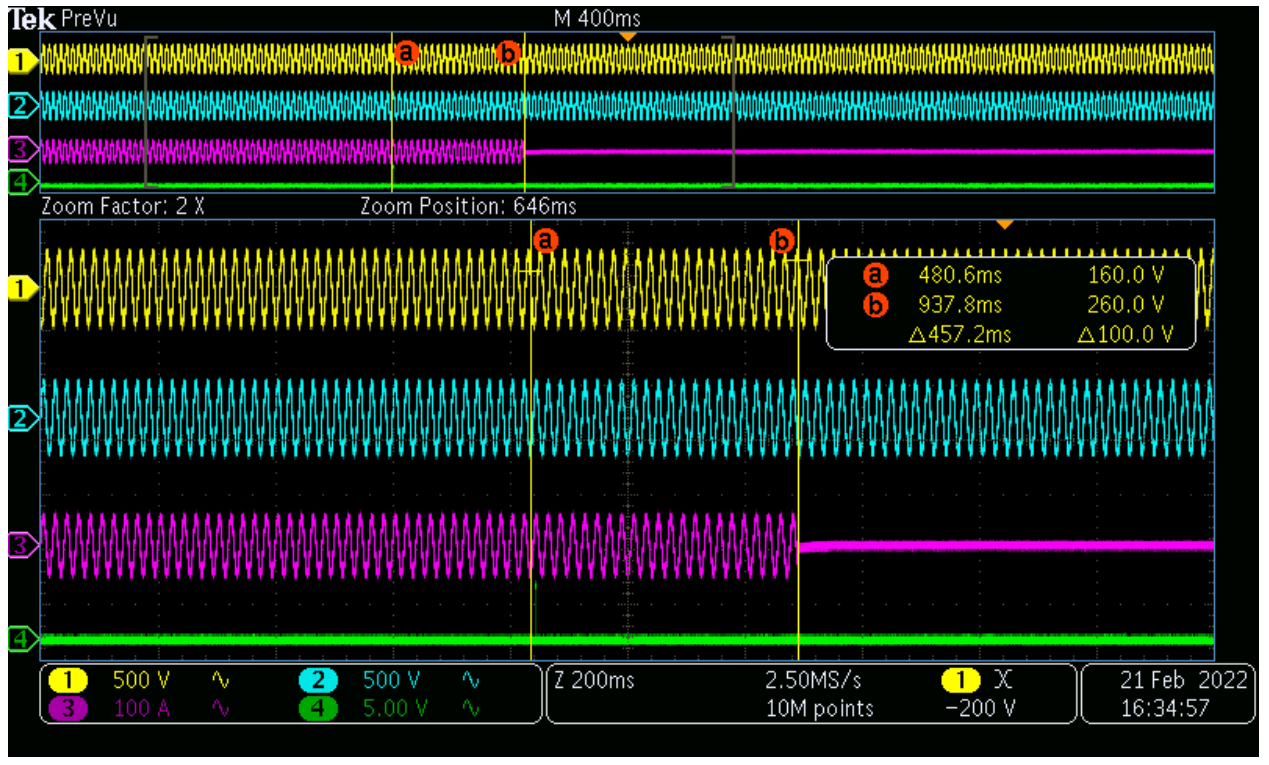

Test 3

Trip Value

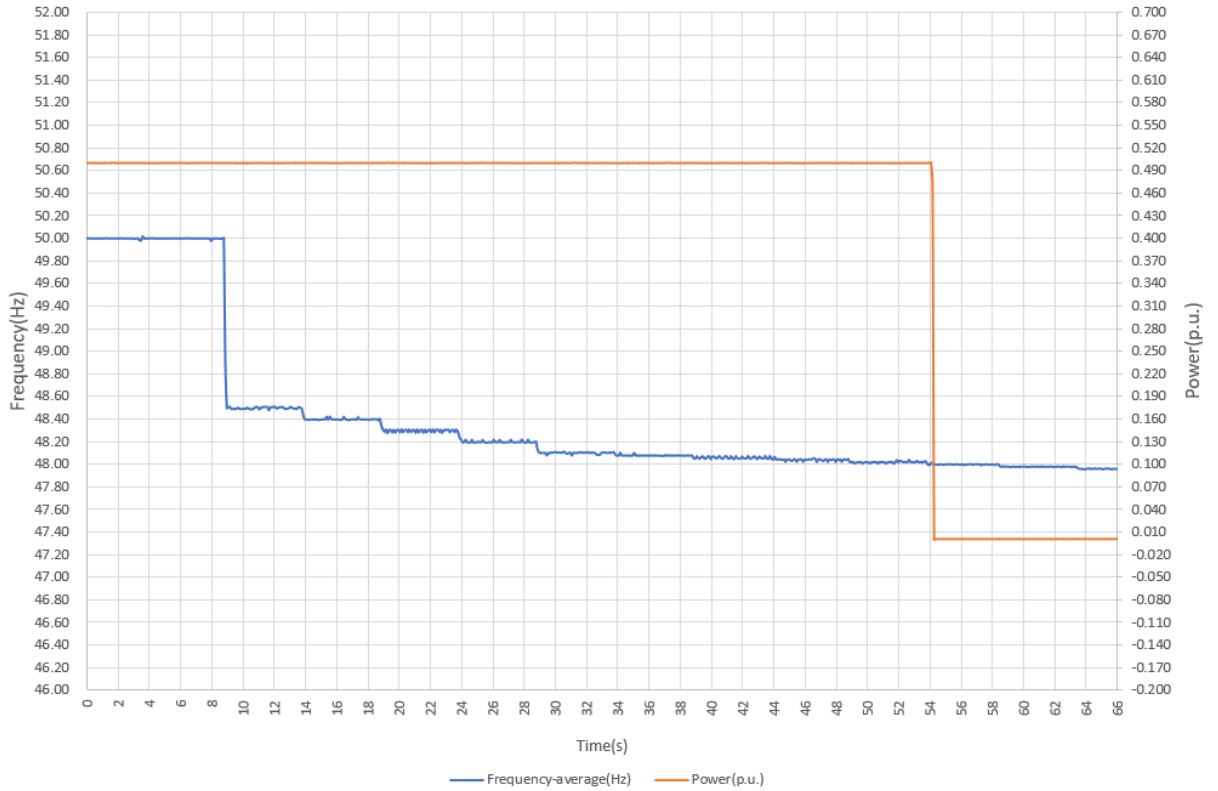

Trip Time

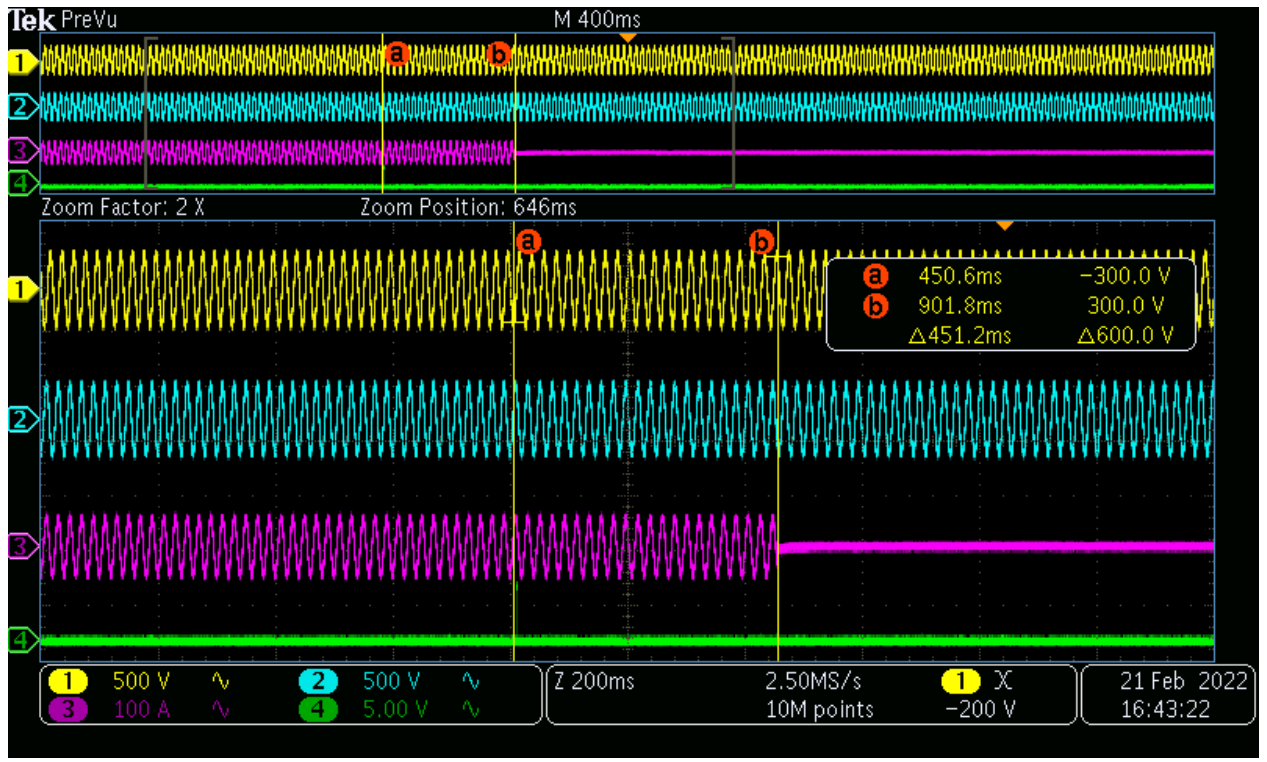

**4.6.2.4 Overfrequency protection (Country / Region: Ireland)**

50Hz +1%				
Parameter	Settings	Test 1	Test 2	Test 3
Trip value [Hz]	50.50	50.50	50.50	50.50
Trip time [s]	< 0.500	0.494	0.484	0.490

Test results are represented at diagrams below.

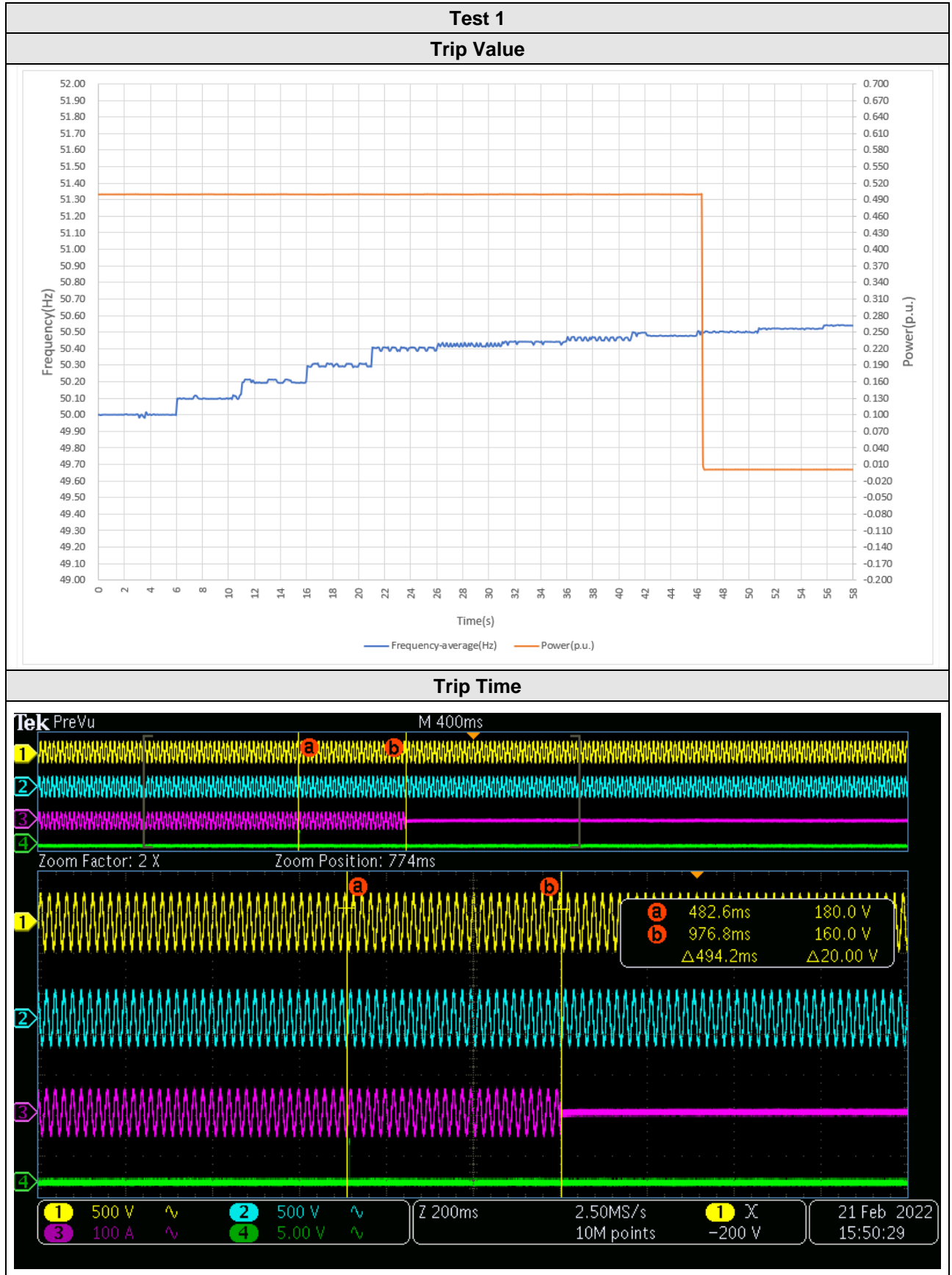

Test 2

Trip Value

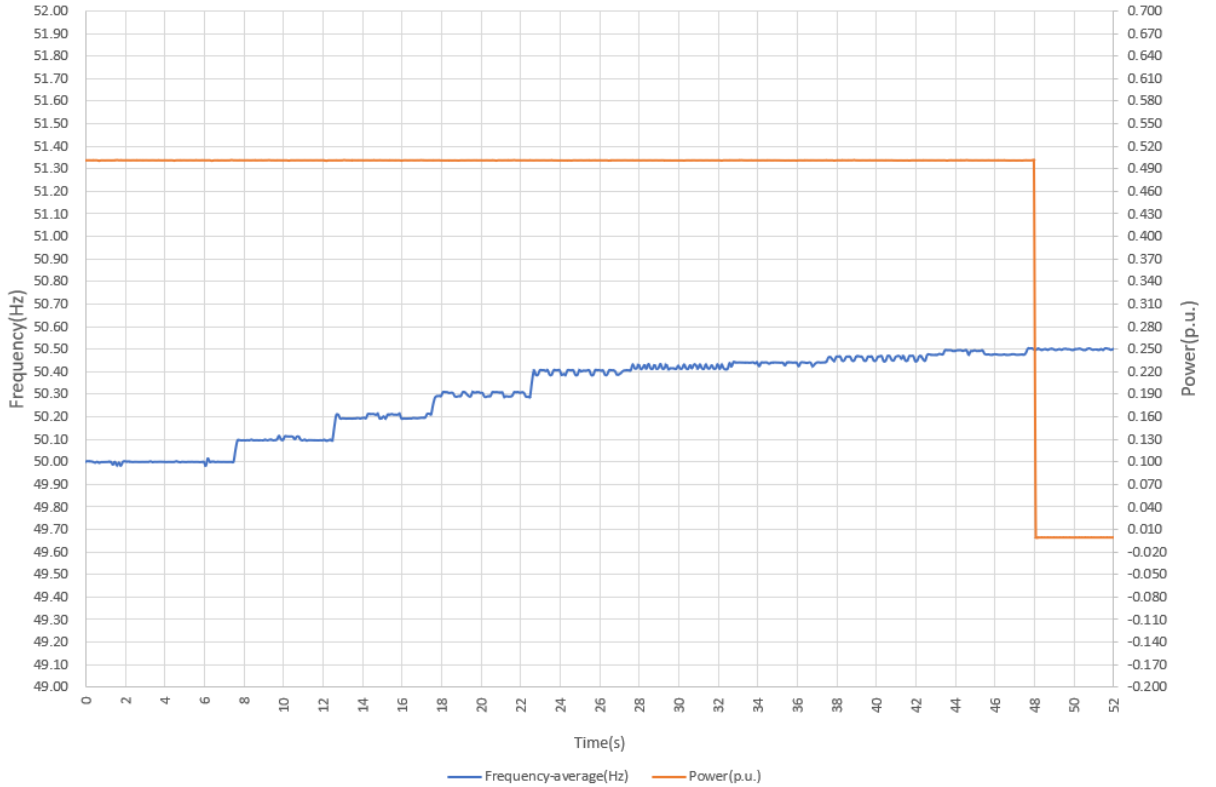

Trip Time

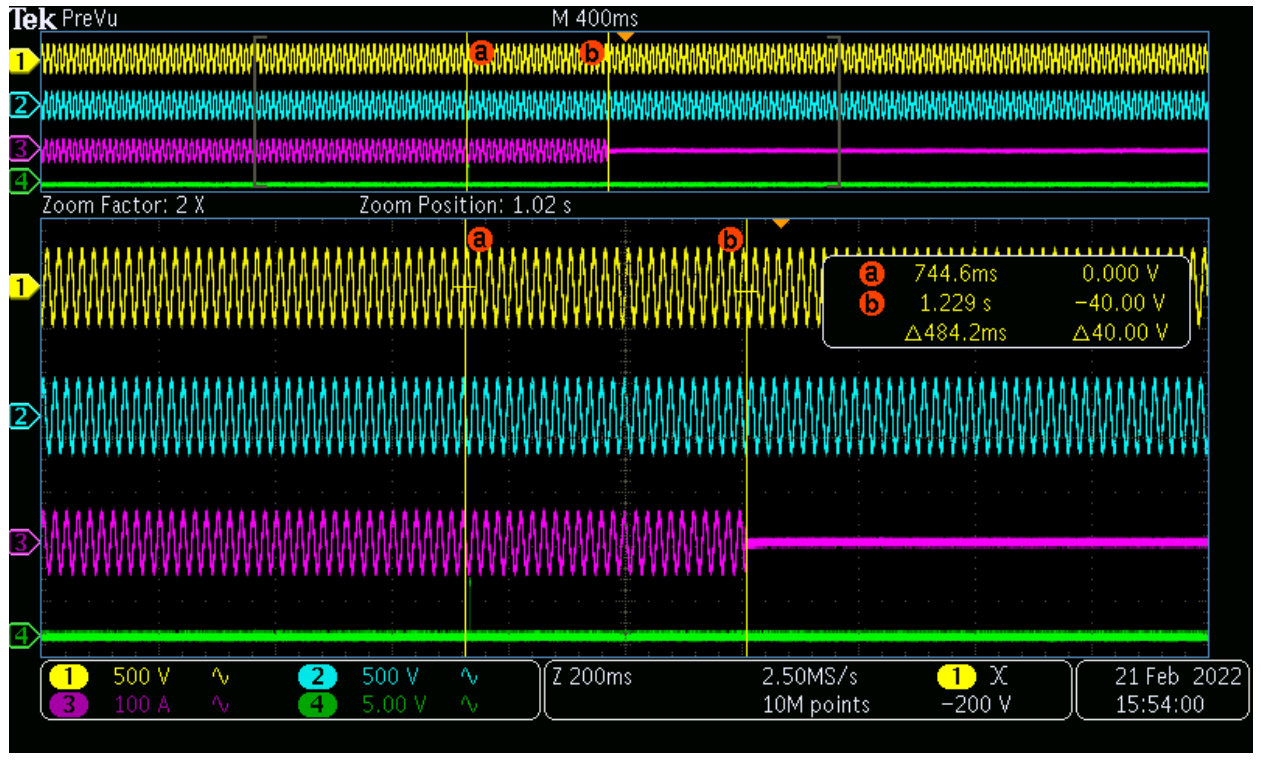



Test 3

Trip Value

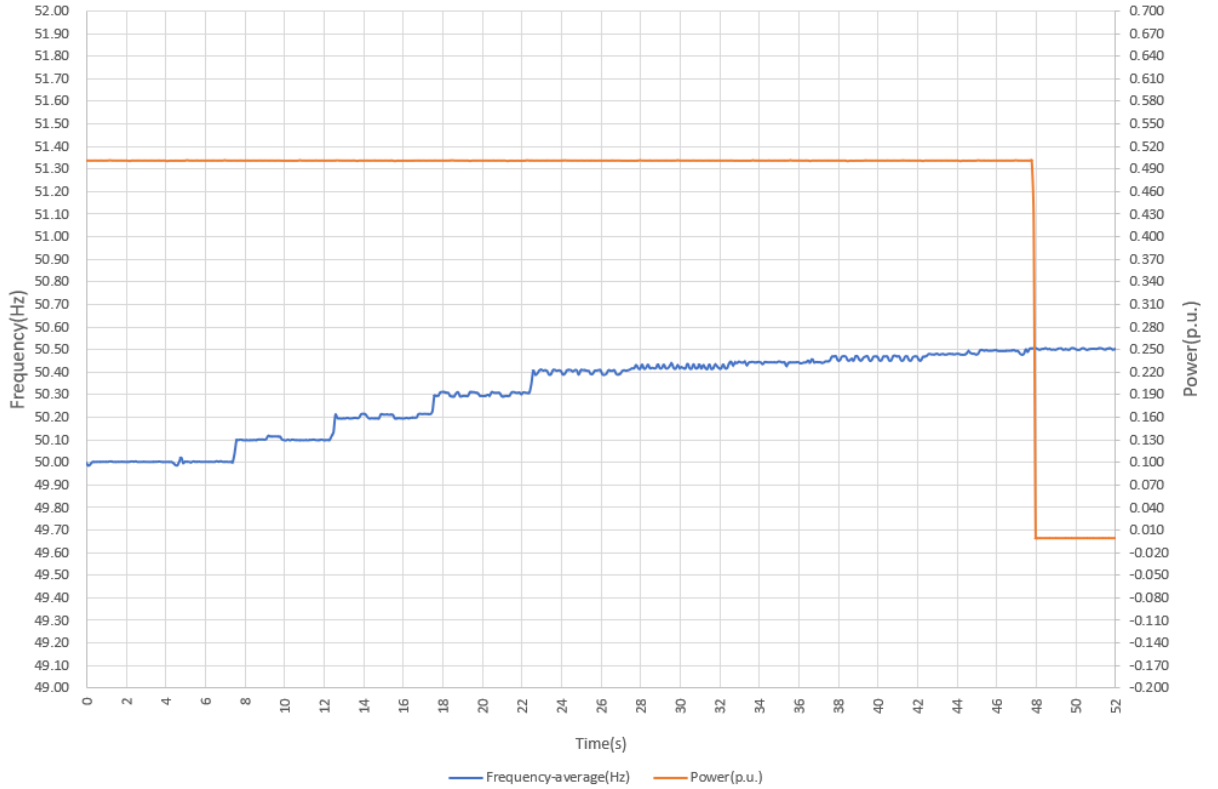

Trip Time

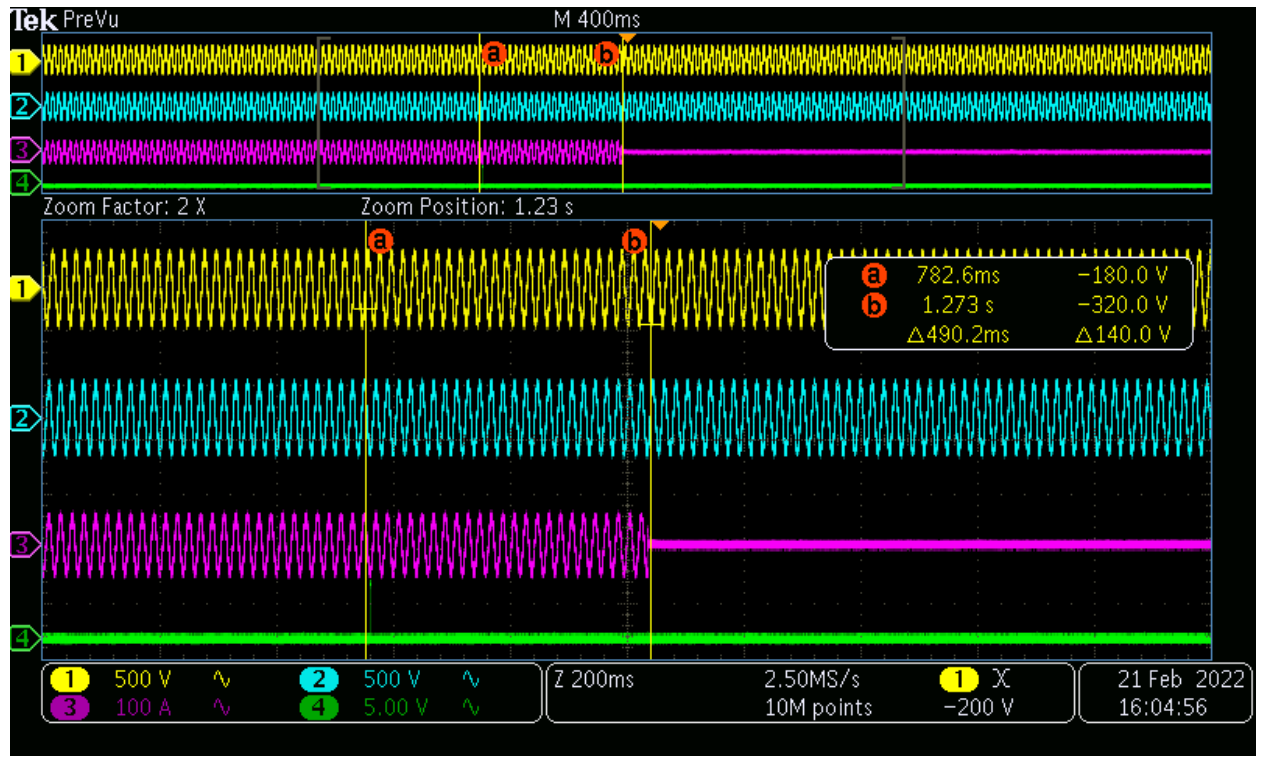

#### 4.6.3. Requirements on voltage and frequency protection (Country / Region included in the default settings: The Netherlands)

Add test **A.16 NL – The Netherlands** for interface protection according to Annex A of the standard EN 50438: 2013 as following:

Parameter	Time(s)	Setting
Over-voltage	2.0	230 V + 10 %
Under-voltage <sup>a</sup>	2.0	230 V – 20 %
Over-frequency	2.0	50.0 Hz + 2 %
Under frequency	2.0	50.0 Hz – 4 %
LoM	--	--

<sup>a</sup> For synchronous generators the disconnecting time is 0.2 s, or a shorter time depending on the Critical Short-circuit Time of the generator.  
In the Netherlands it is only necessary to provide a single stage for under/over-voltage and for frequency protection.

The minimum required accuracy is:

- for frequency measurement  $\pm 0.05$  Hz;
- for voltage measurement  $\pm 1$  % of  $U_n$ .

**4.6.3.1 Undervoltage protection (Country / Region: The Netherlands)**

<b>Undervoltage of 80%Un</b>				
<b>Phase A</b>				
<b>Parameter</b>	<b>Settings</b>	<b>Test 1</b>	<b>Test 2</b>	<b>Test 3</b>
Trip value [V]	184.0	184.2	184.2	184.2
Trip time [s]	< 2.000	1.438	1.418	1.442
<b>Phase B</b>				
<b>Parameter</b>	<b>Settings</b>	<b>Test 1</b>	<b>Test 2</b>	<b>Test 3</b>
Trip value [V]	184.0	184.1	184.1	184.1
Trip time [s]	< 2.000	1.430	1.418	1.438
<b>Phase C</b>				
<b>Parameter</b>	<b>Settings</b>	<b>Test 1</b>	<b>Test 2</b>	<b>Test 3</b>
Trip value [V]	184.0	184.1	184.1	184.1
Trip time [s]	< 2.000	1.430	1.422	1.430
<b>Phase ABC</b>				
<b>Parameter</b>	<b>Settings</b>	<b>Test 1</b>	<b>Test 2</b>	<b>Test 3</b>
Trip value [V]	184.0	184.0	184.1	184.1
Trip time [s]	< 2.000	1.446	1.446	1.434

Test results are represented at diagrams below.

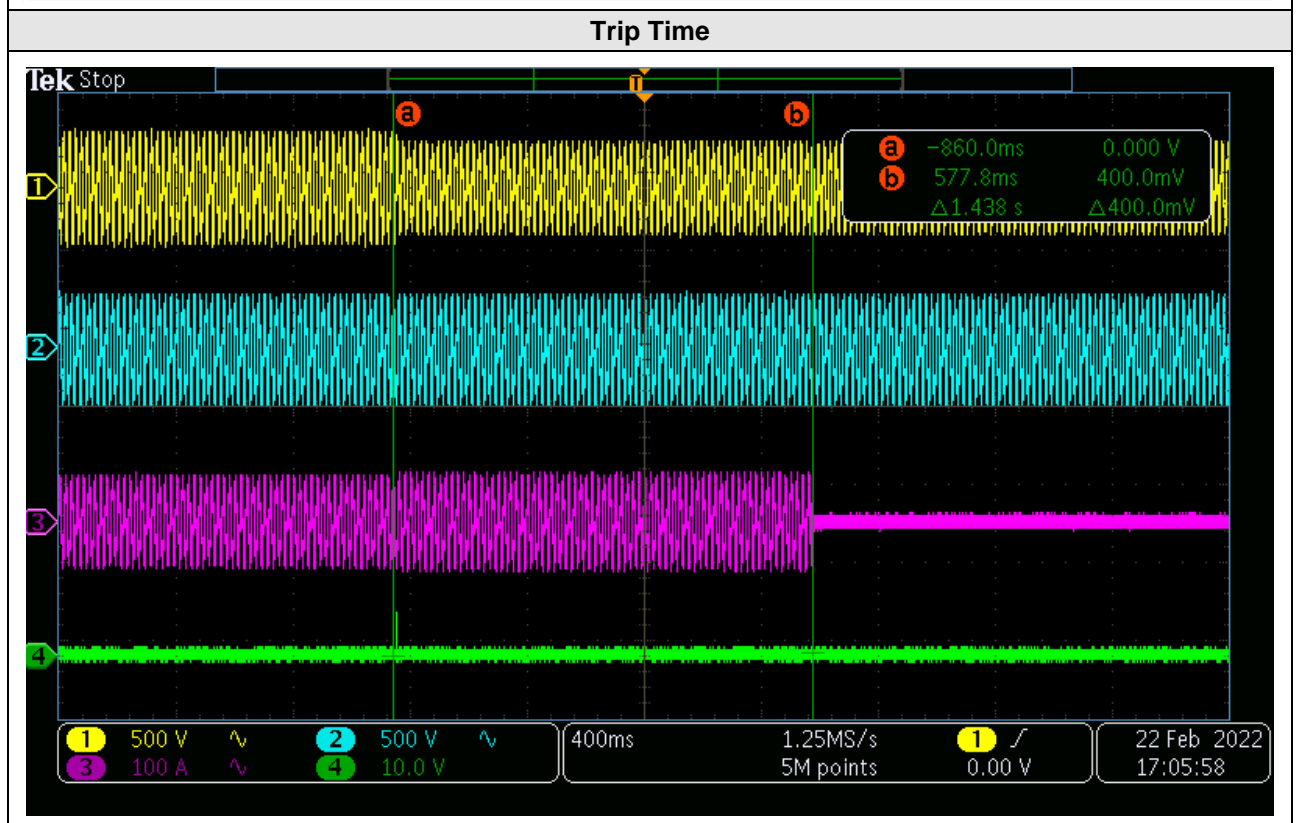
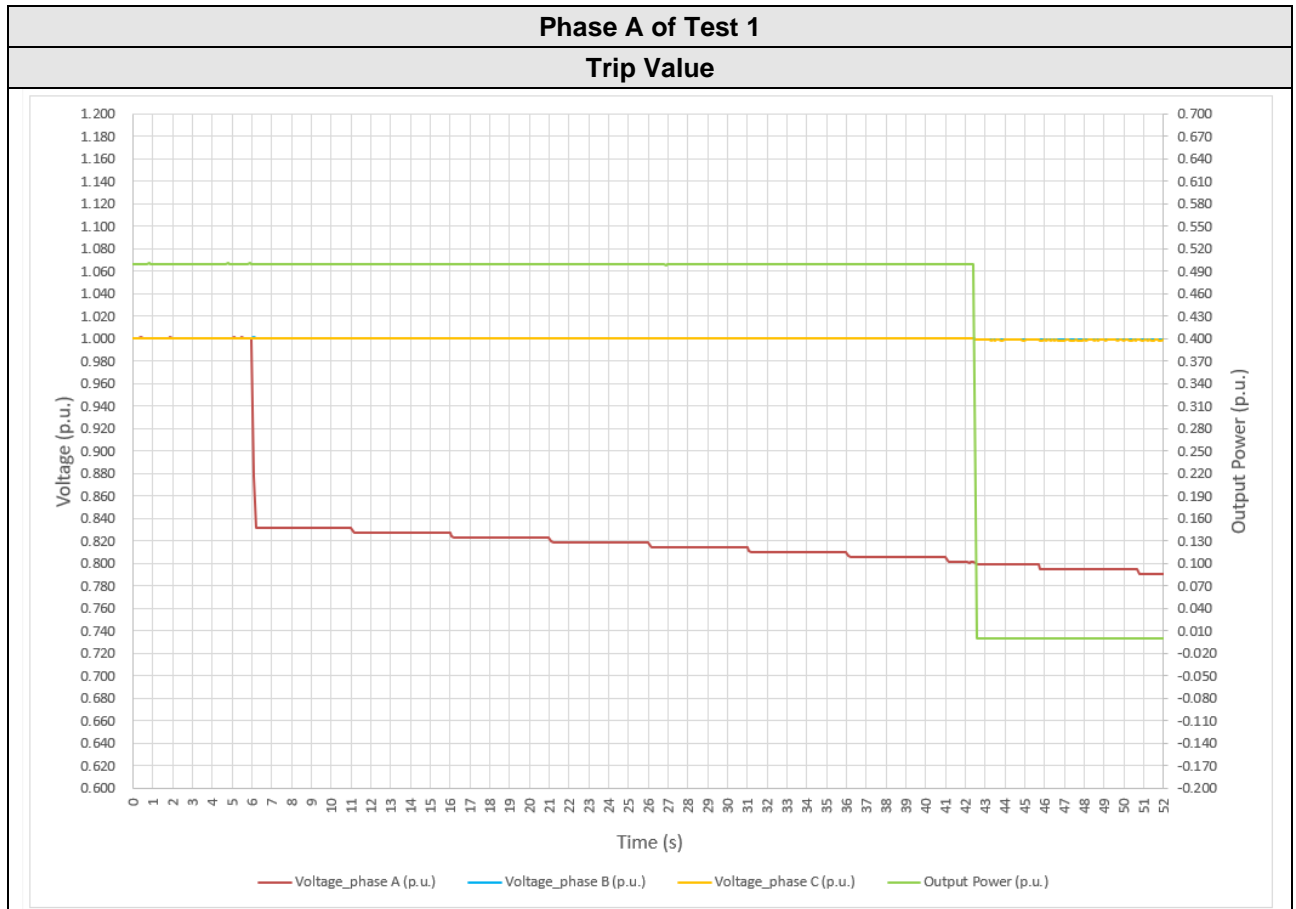

Phase A of Test 2

Trip Value

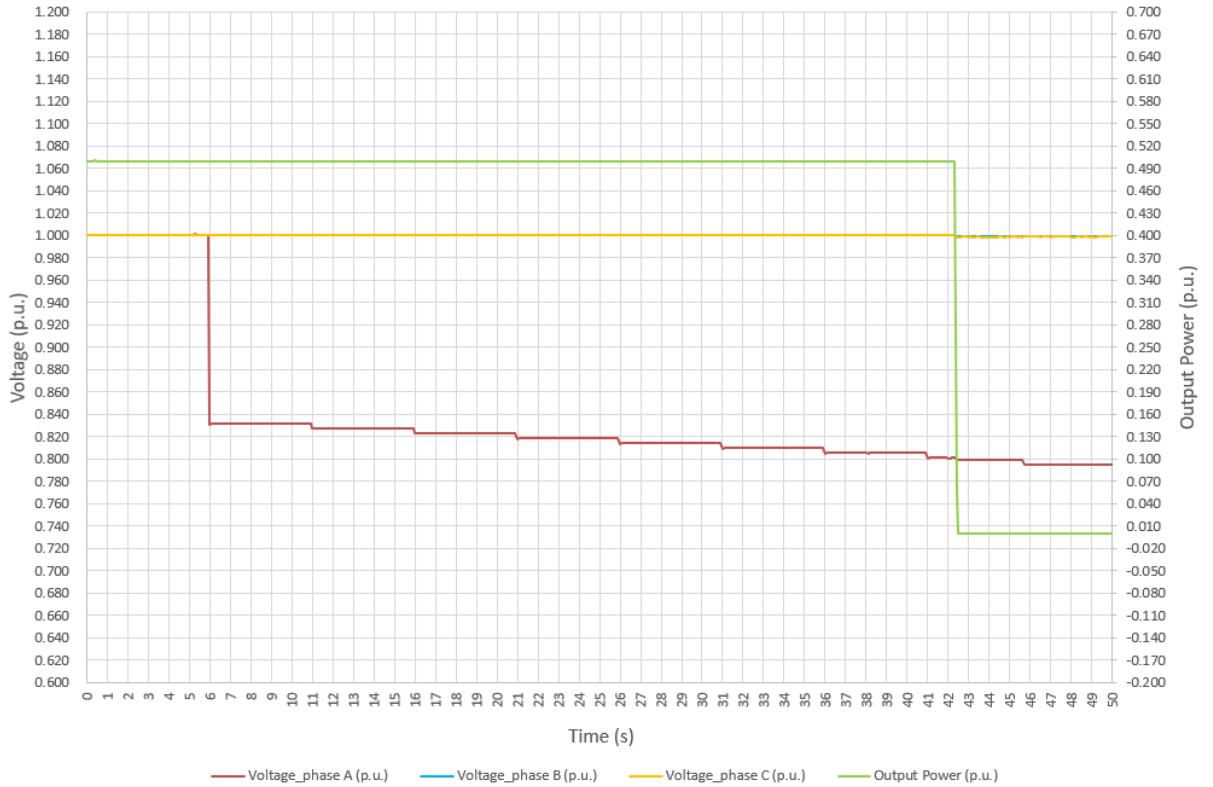

Trip Time

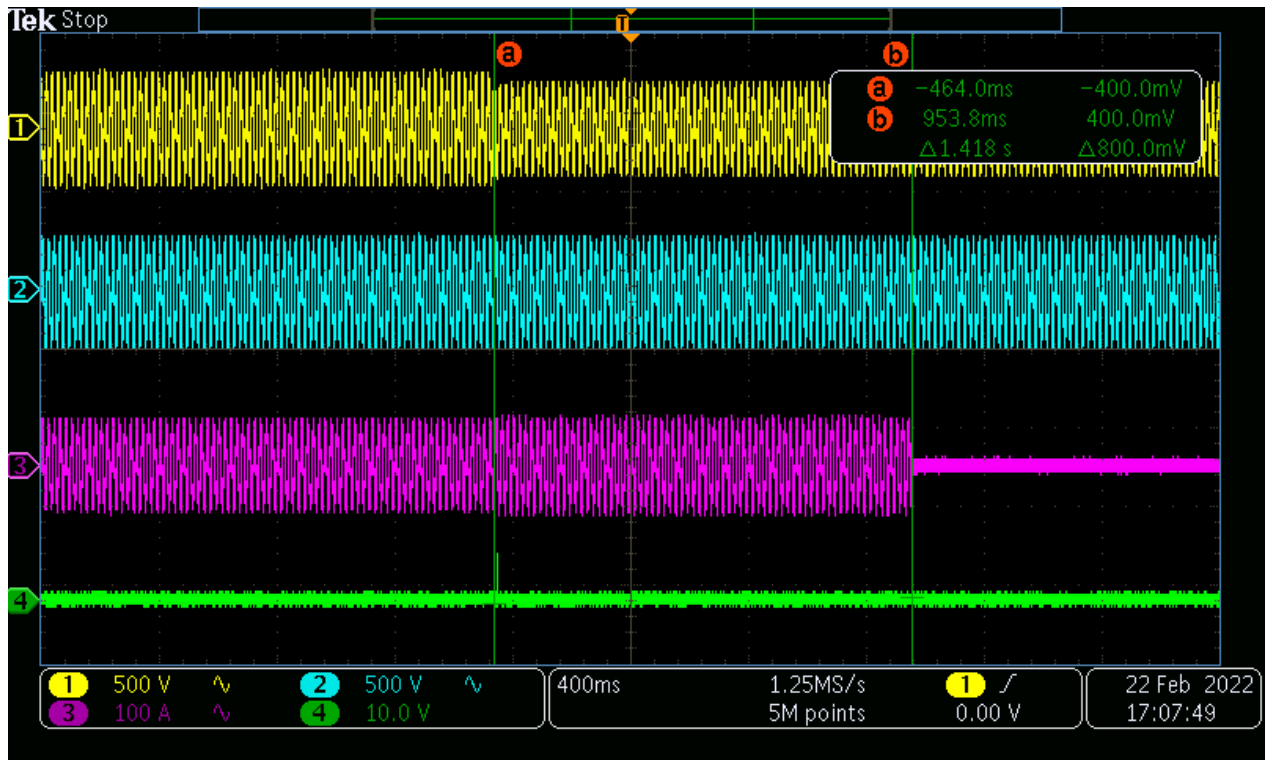

Phase A of Test 3

Trip Value

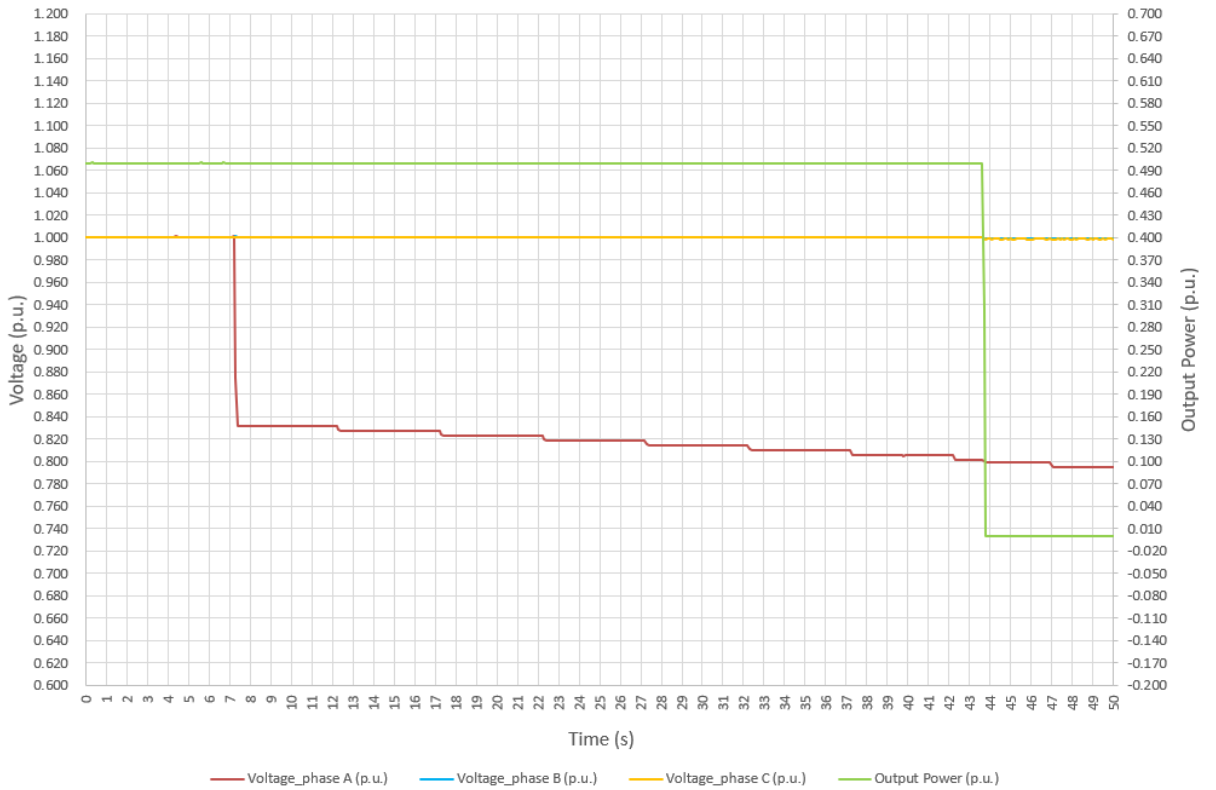

Trip Time

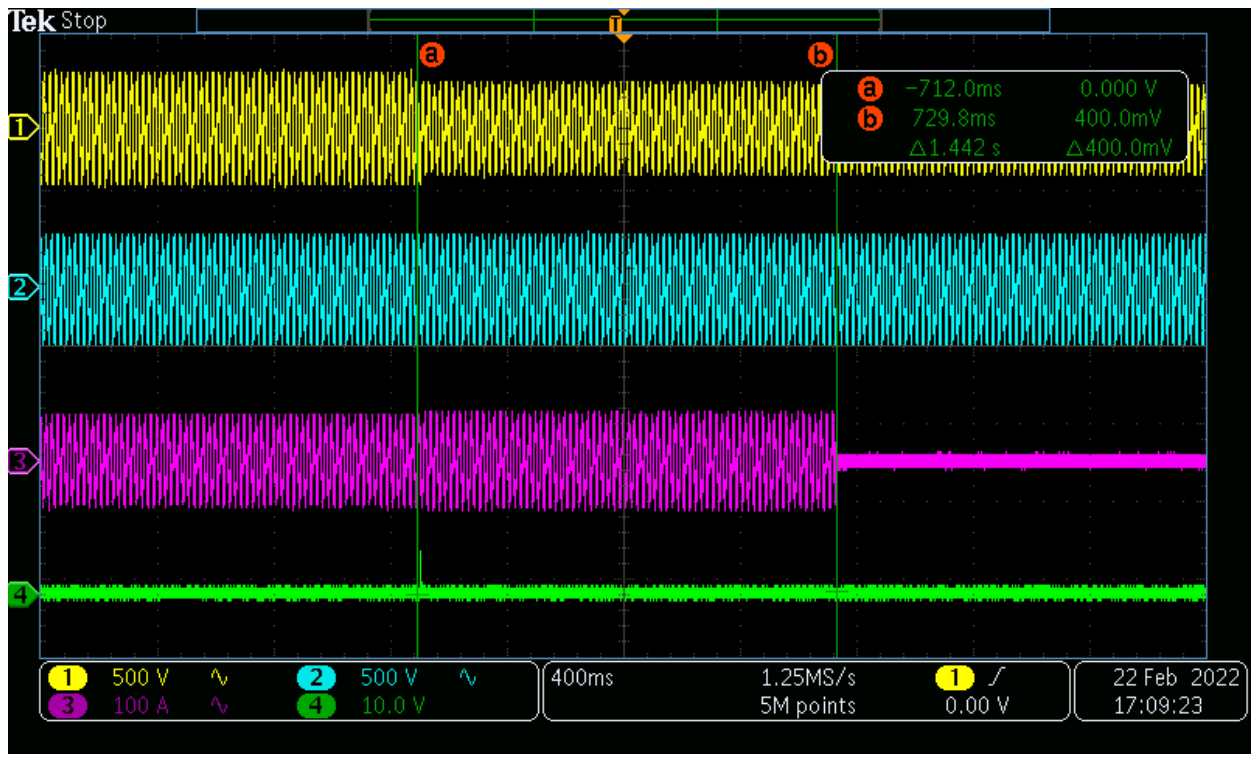

Phase B of Test 1

Trip Value



Trip Time

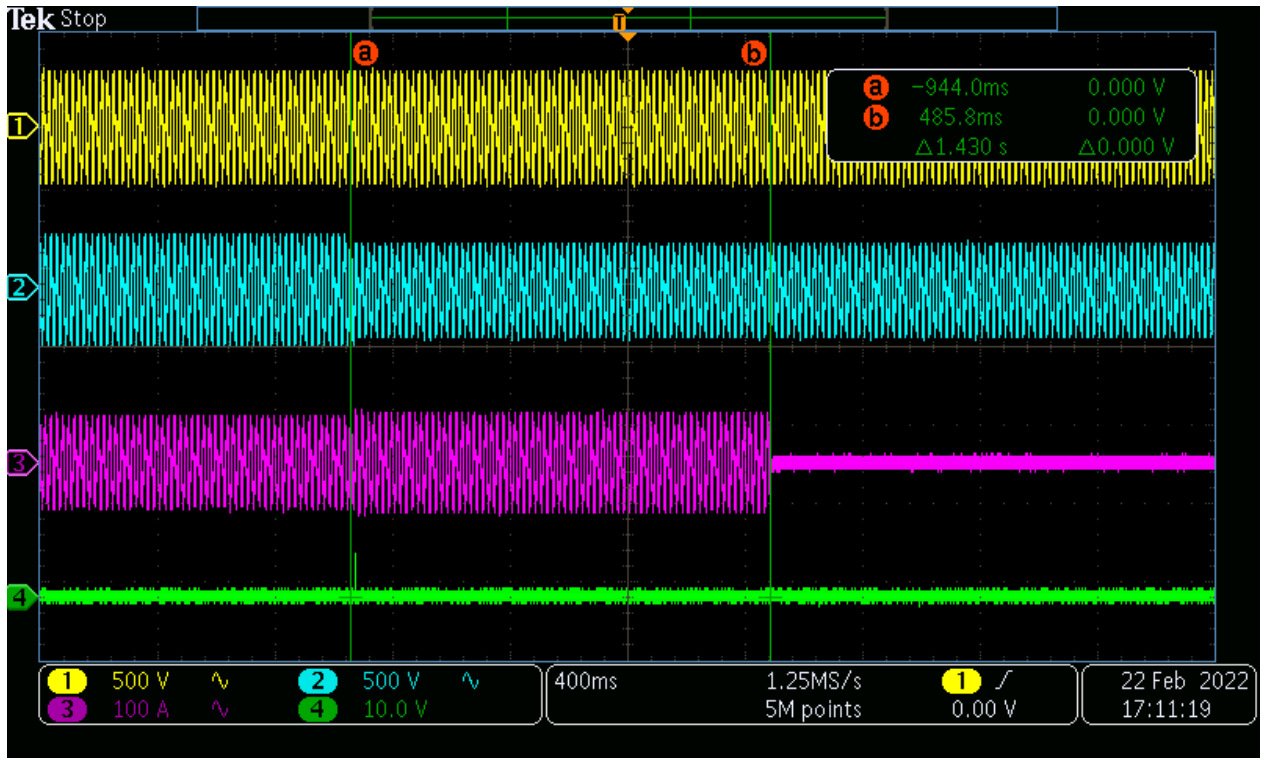

Phase B of Test 2

Trip Value

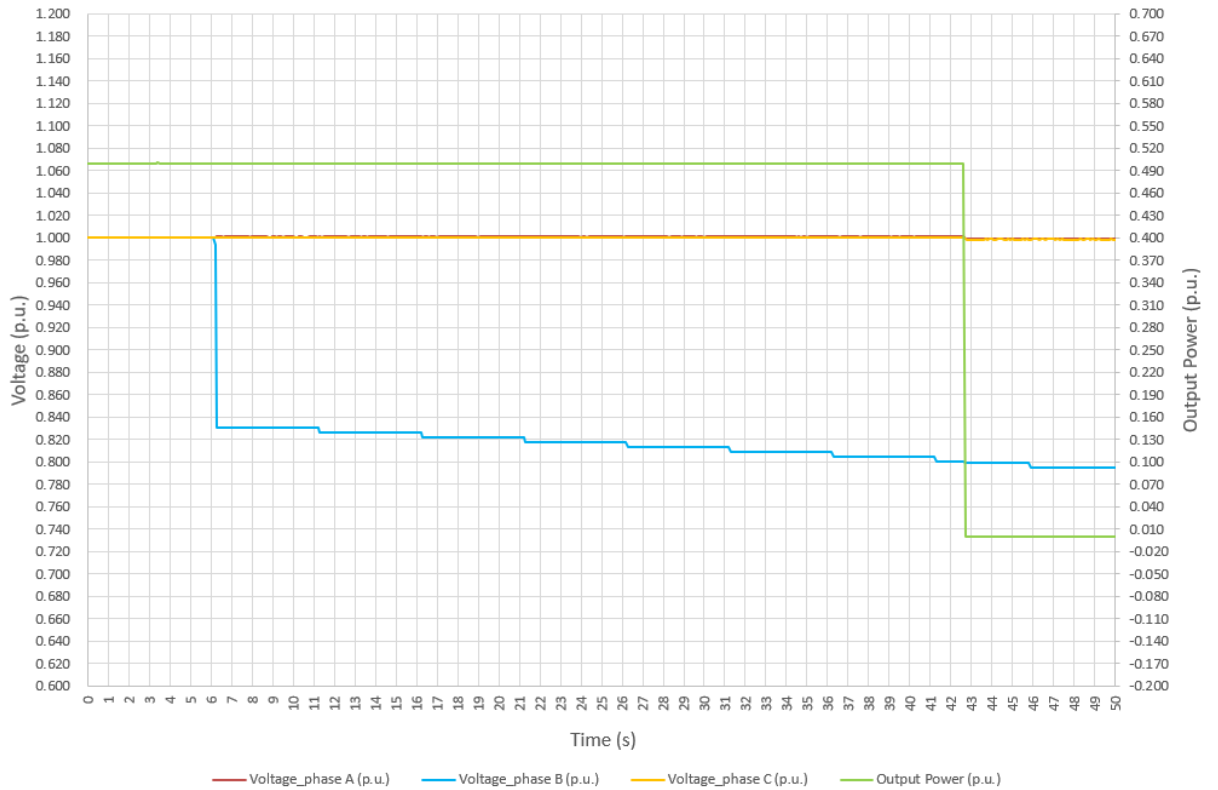

Trip Time

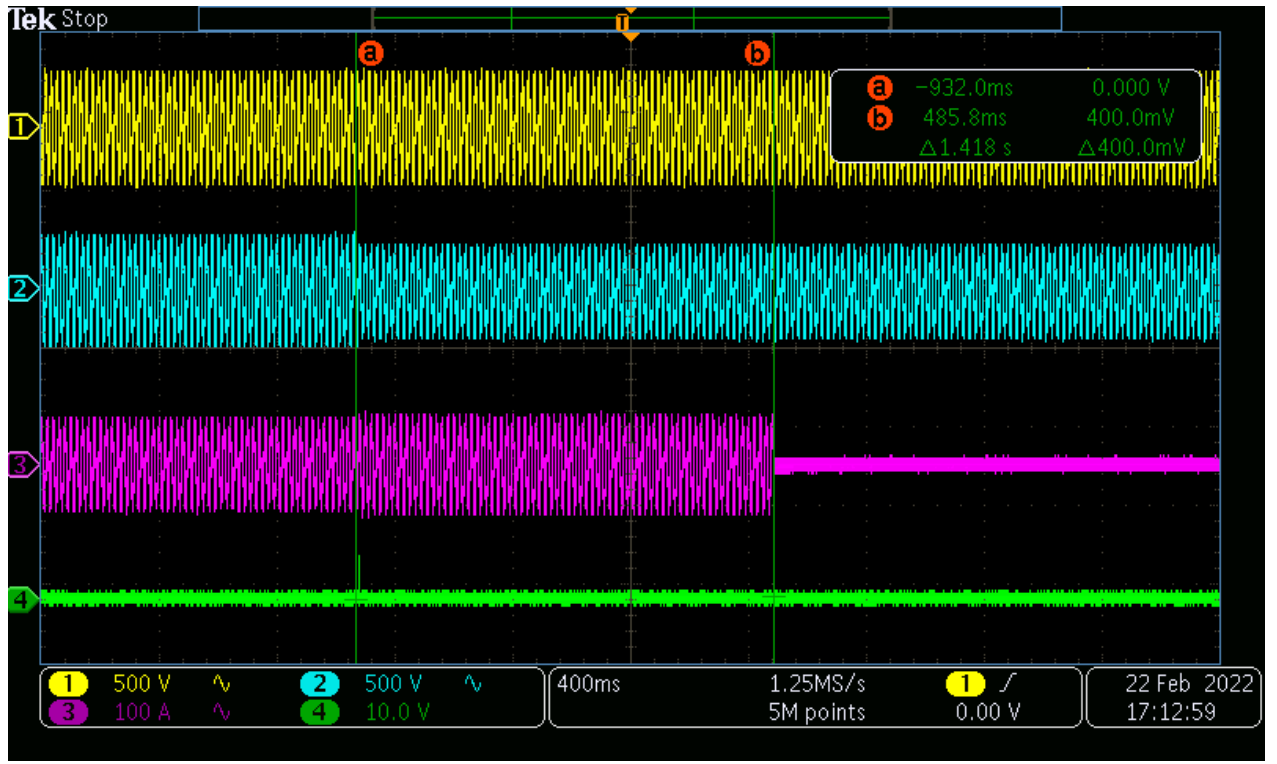



Phase B of Test 3

Trip Value



Trip Time

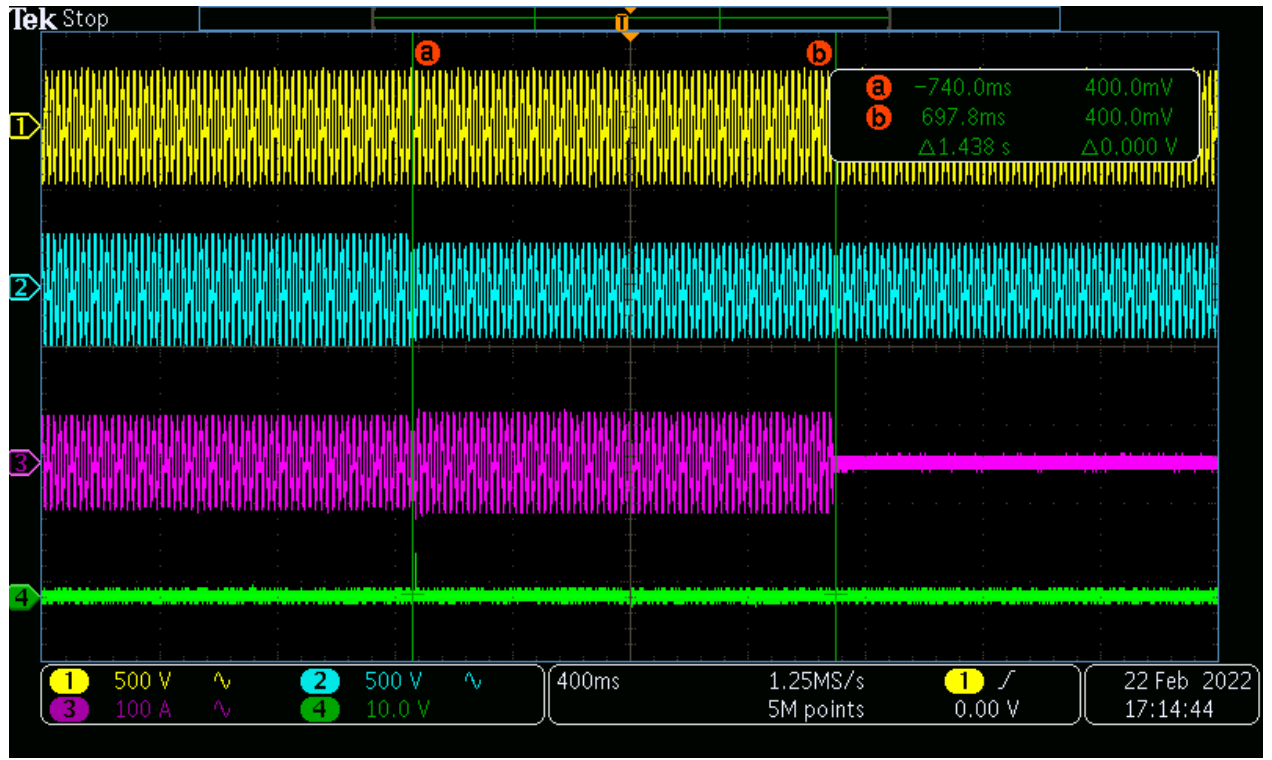

Phase C of Test 1

Trip Value



Trip Time

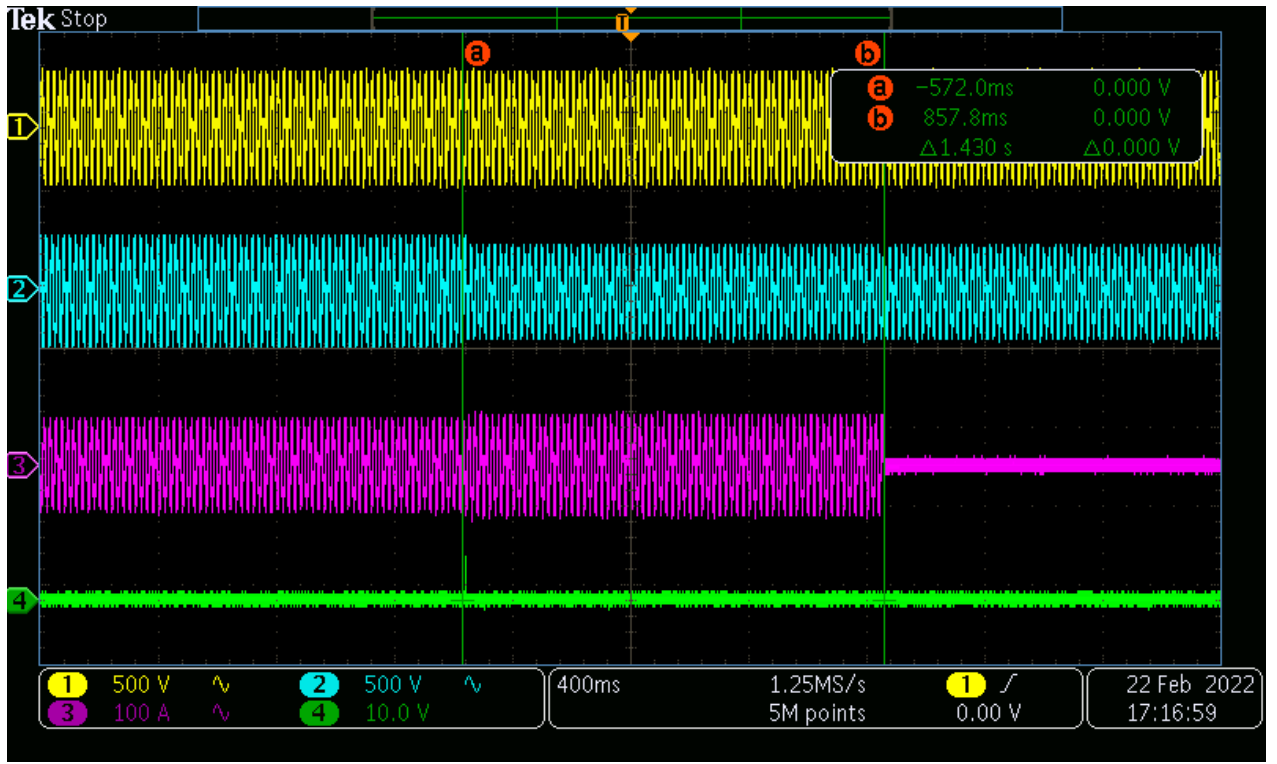

Phase C of Test 2

Trip Value

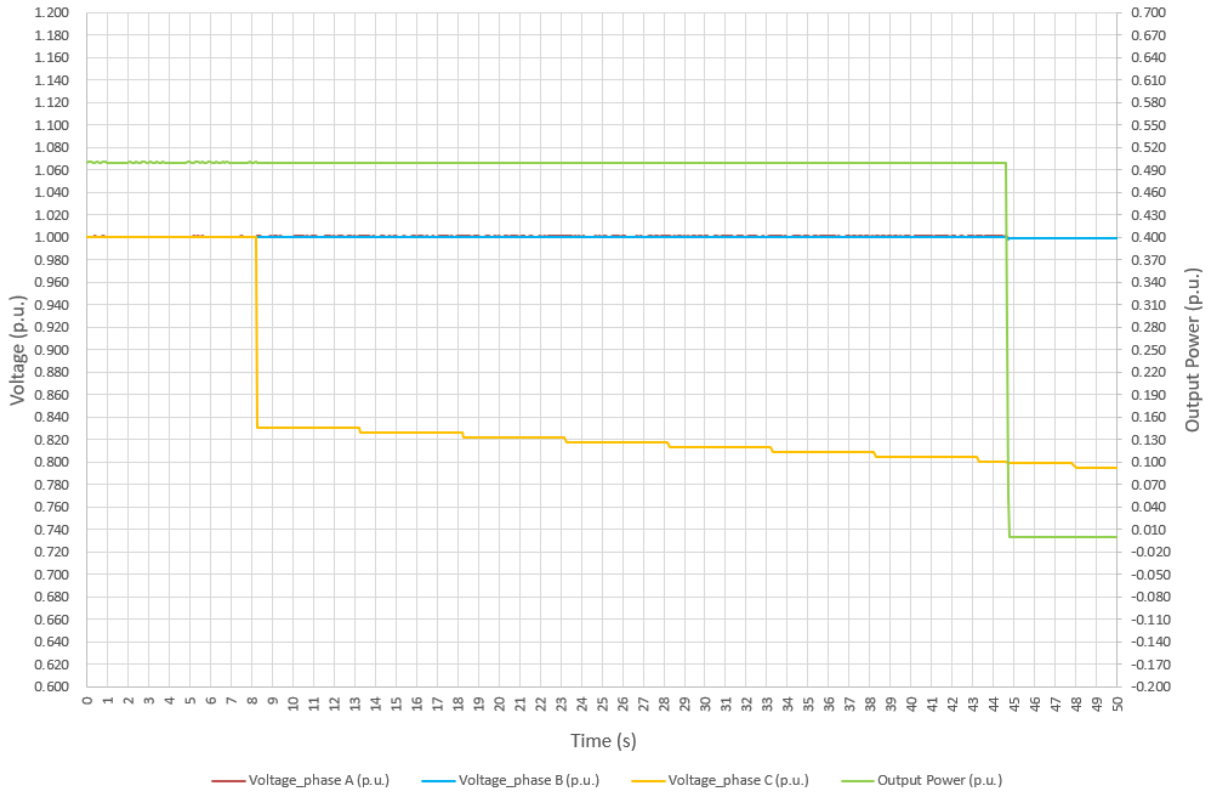

Trip Time

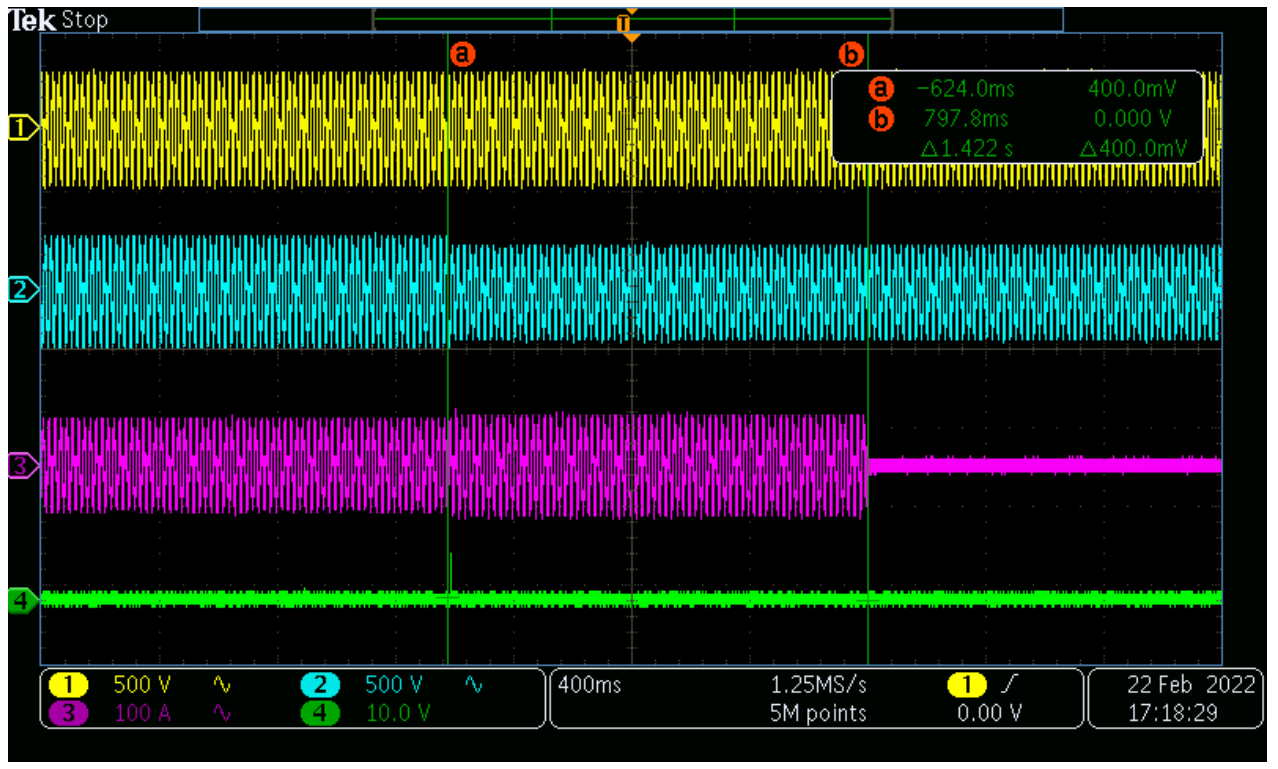

Phase C of Test 3

Trip Value



Trip Time

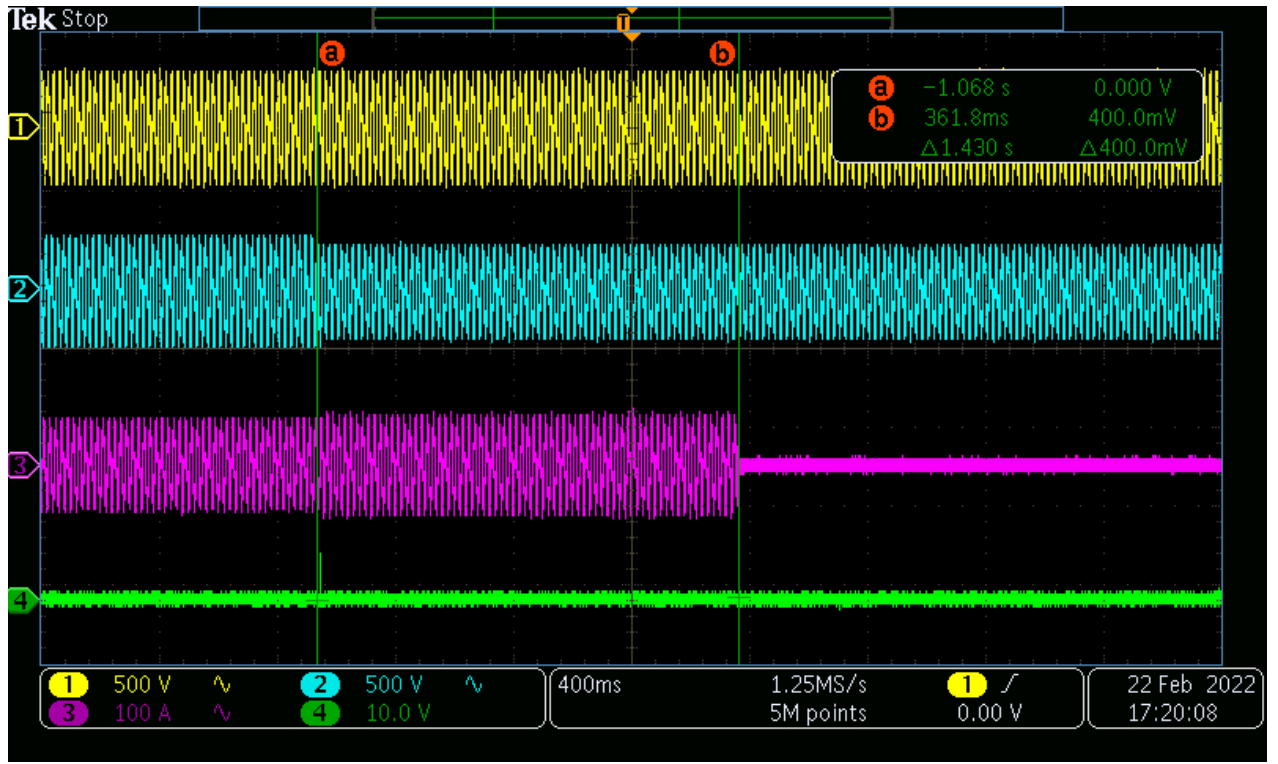

Phase ABC of Test 1

Trip Value

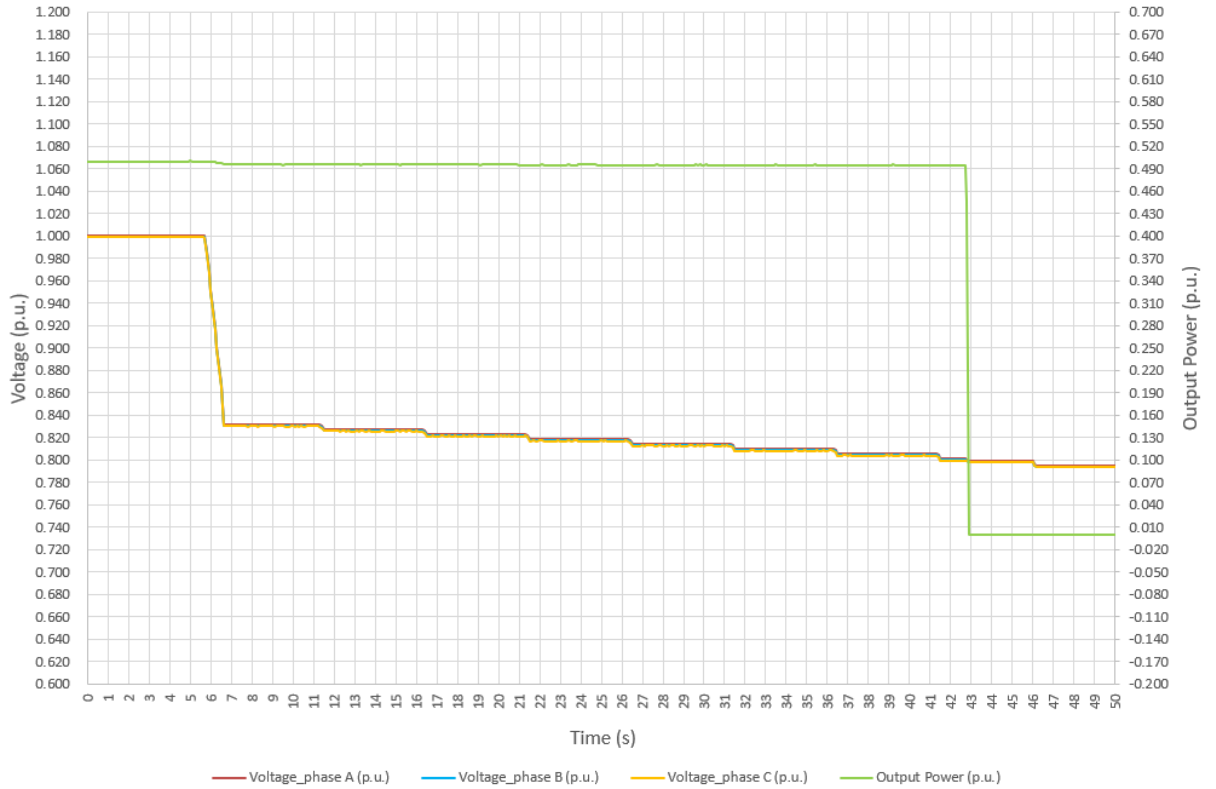

Trip Time

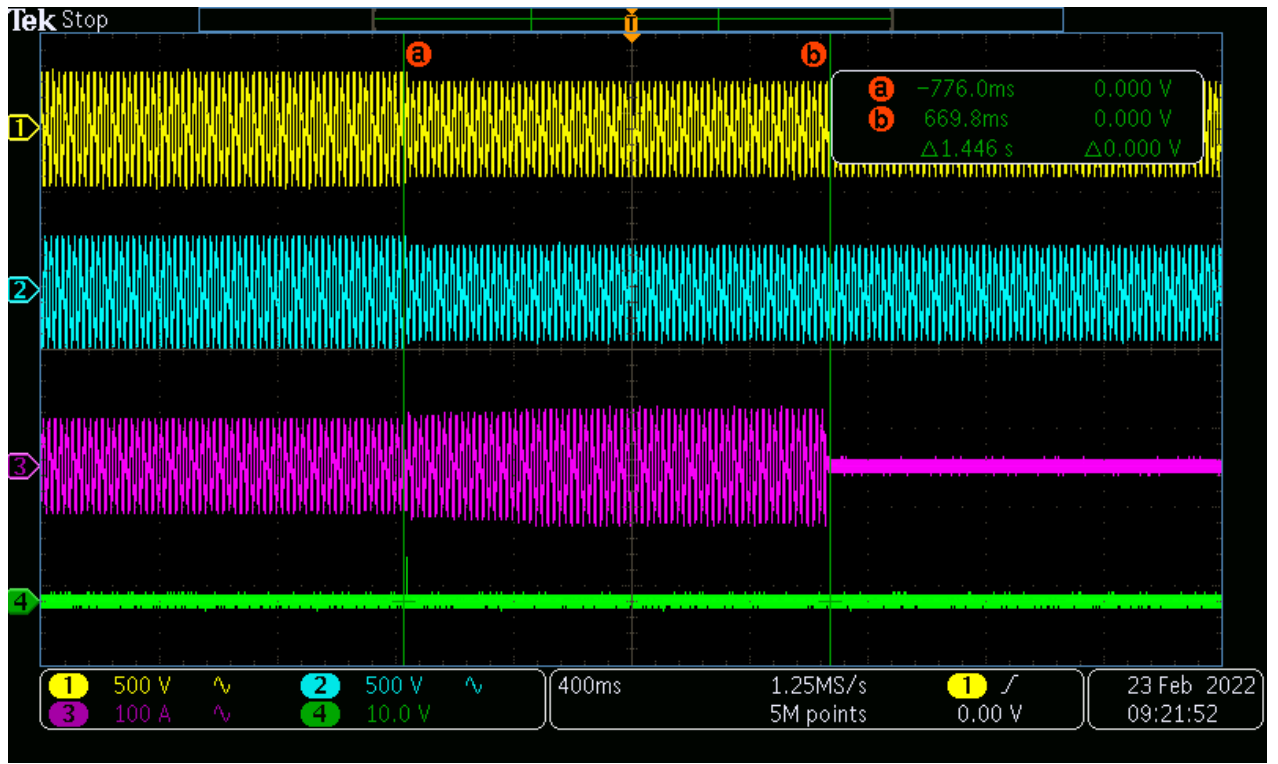

Phase ABC of Test 2

Trip Value

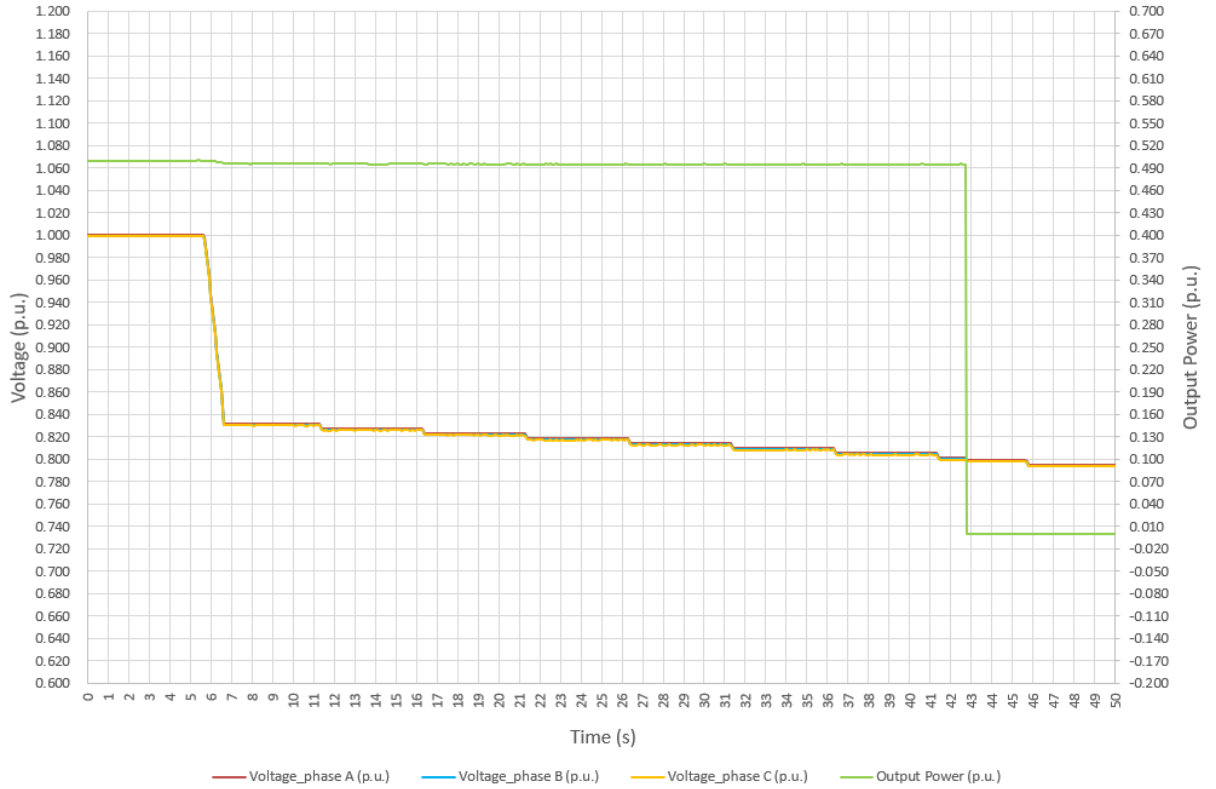

Trip Time

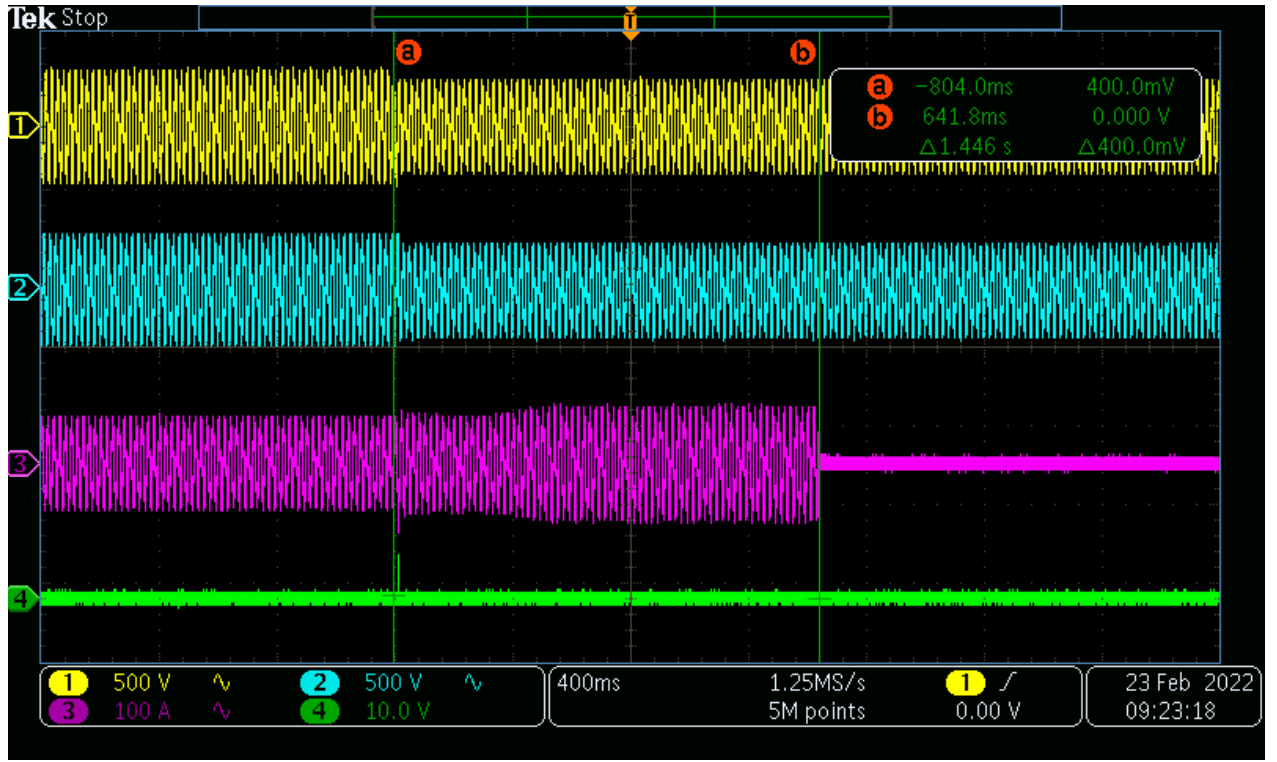

Phase ABC of Test 3

Trip Value

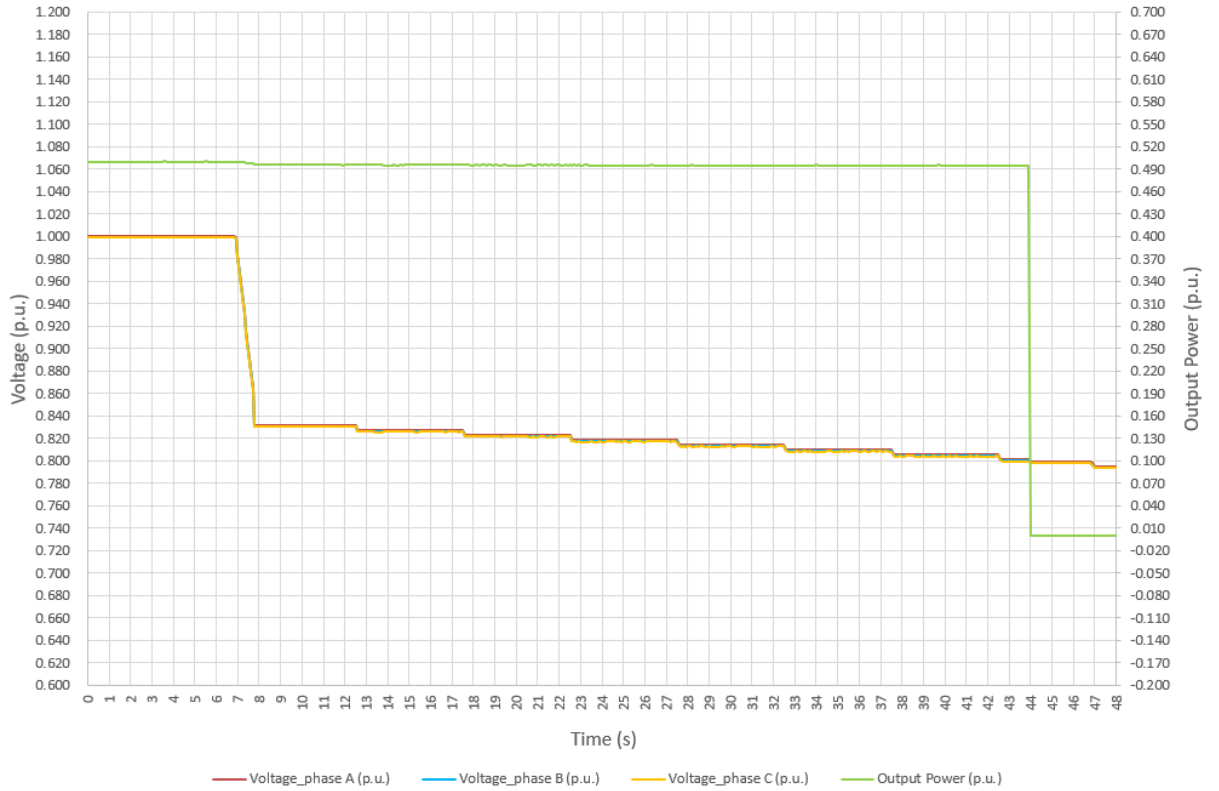

Trip Time

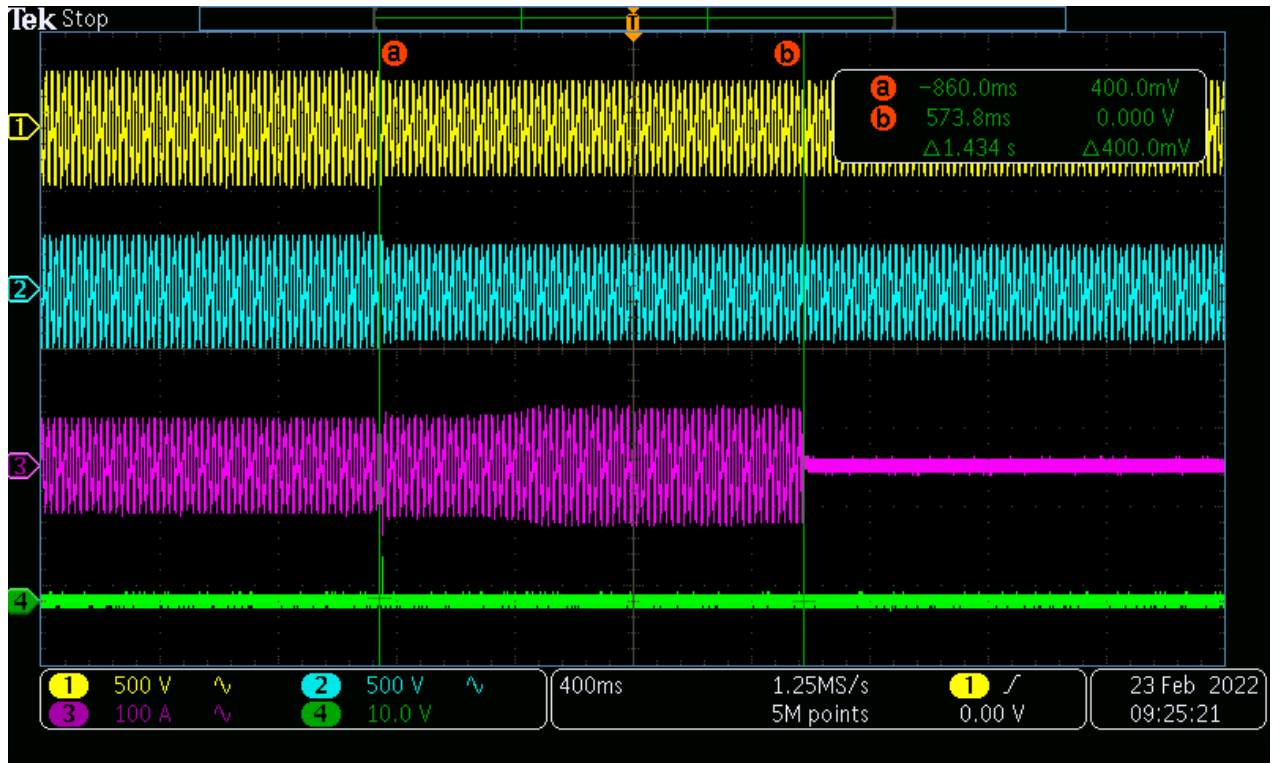

**4.6.3.2 Overvoltage protection (Country / Region: The Netherlands)**

<b>Overvoltage of 110%Un</b>				
<b>Phase A</b>				
<b>Parameter</b>	<b>Settings</b>	<b>Test 1</b>	<b>Test 2</b>	<b>Test 3</b>
Trip value [V]	253.0	253.2	253.2	253.2
Trip time [s]	< 2.000	1.454	1.442	1.450
<b>Phase B</b>				
<b>Parameter</b>	<b>Settings</b>	<b>Test 1</b>	<b>Test 2</b>	<b>Test 3</b>
Trip value [V]	253.0	253.0	253.0	253.0
Trip time [s]	< 2.000	1.450	1.434	1.446
<b>Phase C</b>				
<b>Parameter</b>	<b>Settings</b>	<b>Test 1</b>	<b>Test 2</b>	<b>Test 3</b>
Trip value [V]	253.0	253.0	253.0	253.0
Trip time [s]	< 2.000	1.446	1.438	1.438
<b>Phase ABC</b>				
<b>Parameter</b>	<b>Settings</b>	<b>Test 1</b>	<b>Test 2</b>	<b>Test 3</b>
Trip value [V]	253.0	252.9	252.9	252.9
Trip time [s]	< 2.000	1.450	1.434	1.430



Test results are represented at diagrams below.

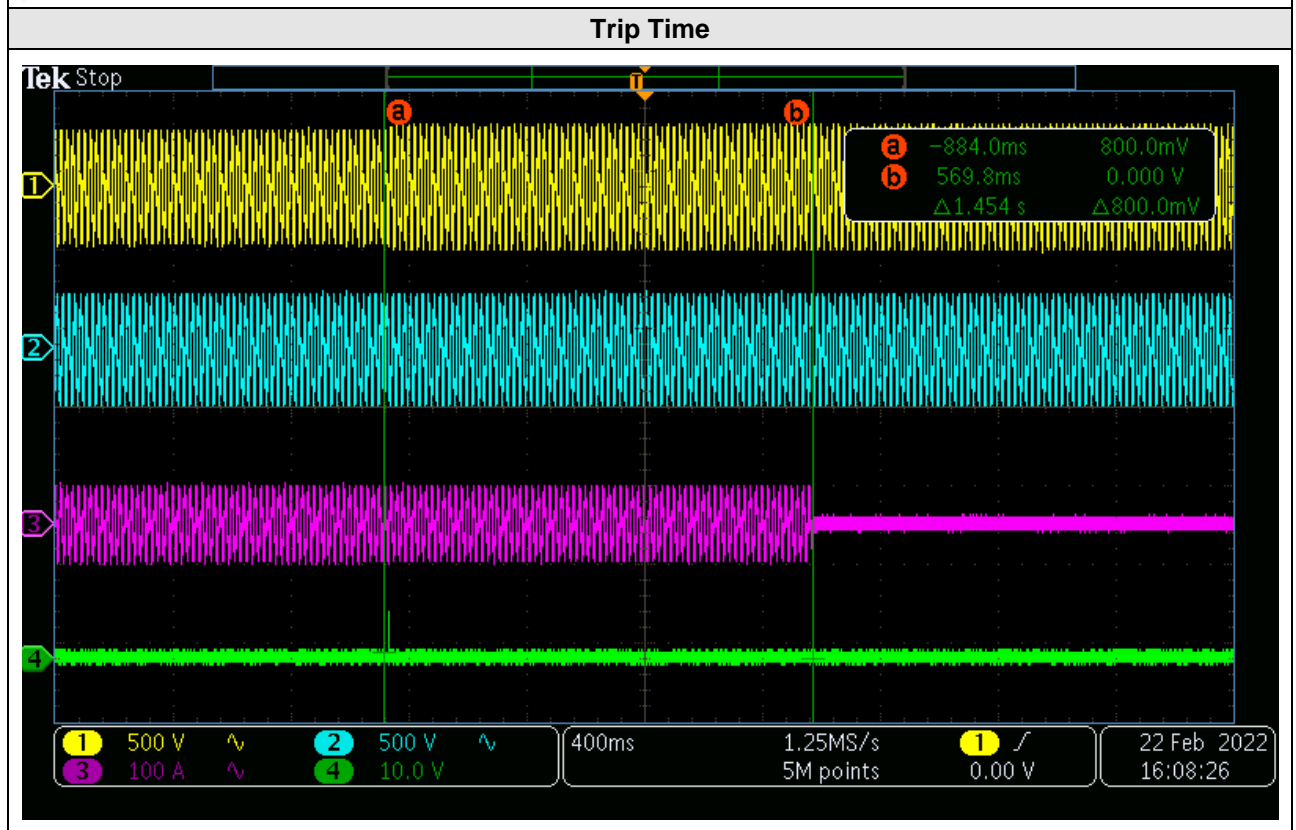
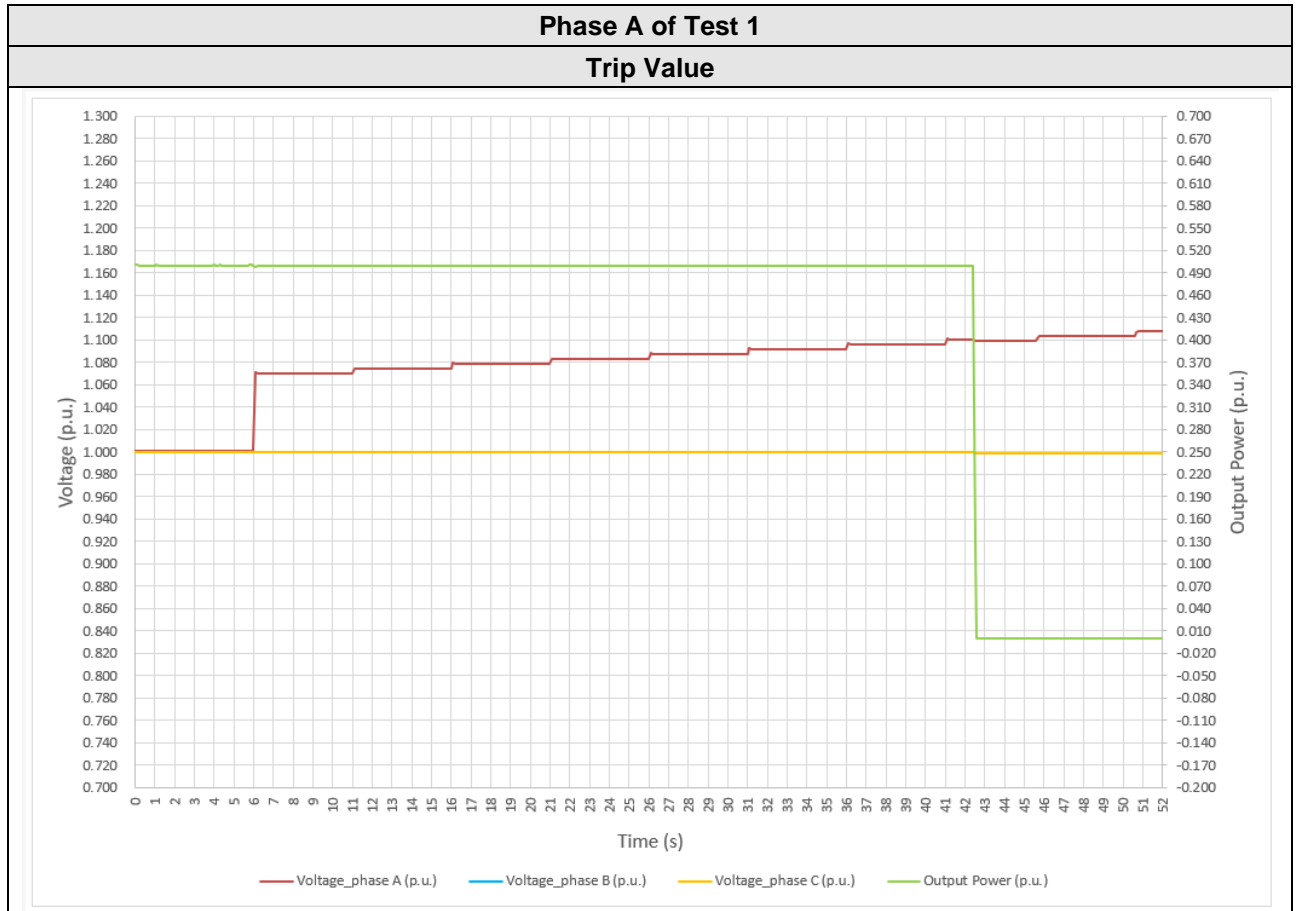

Phase A of Test 2

Trip Value

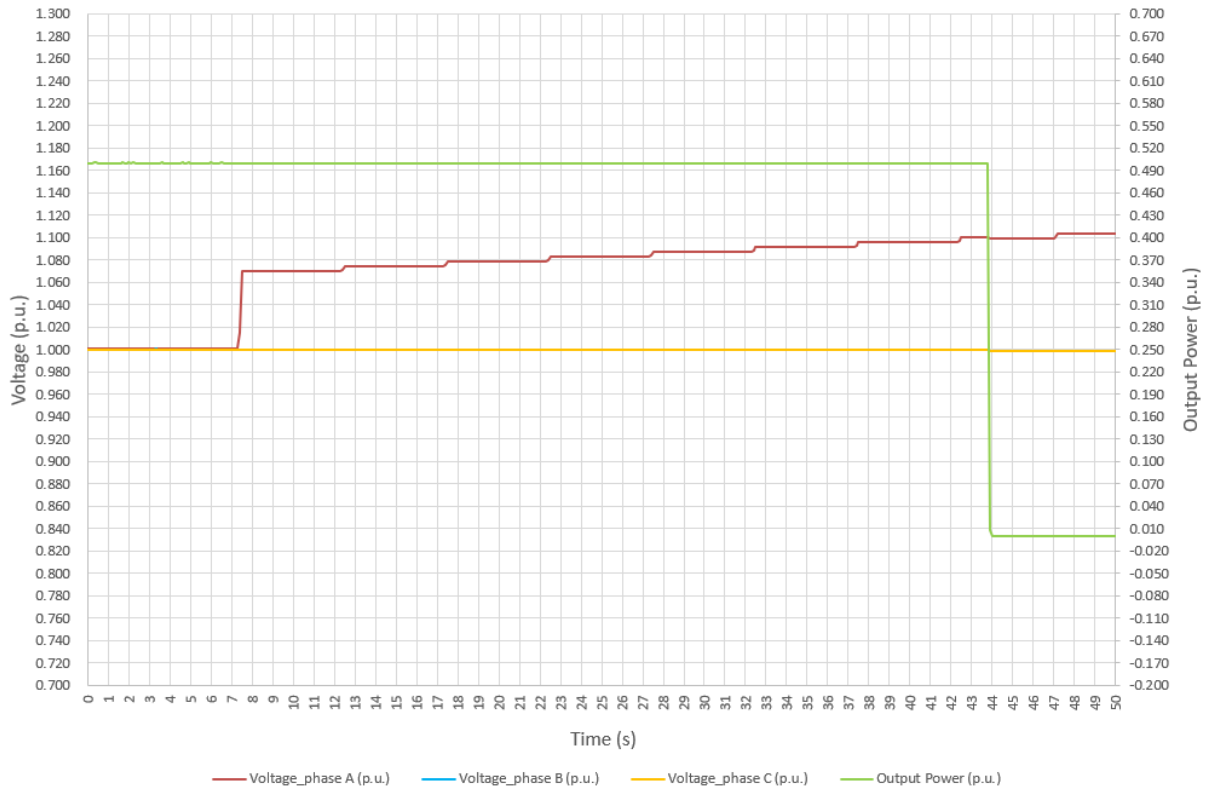

Trip Time

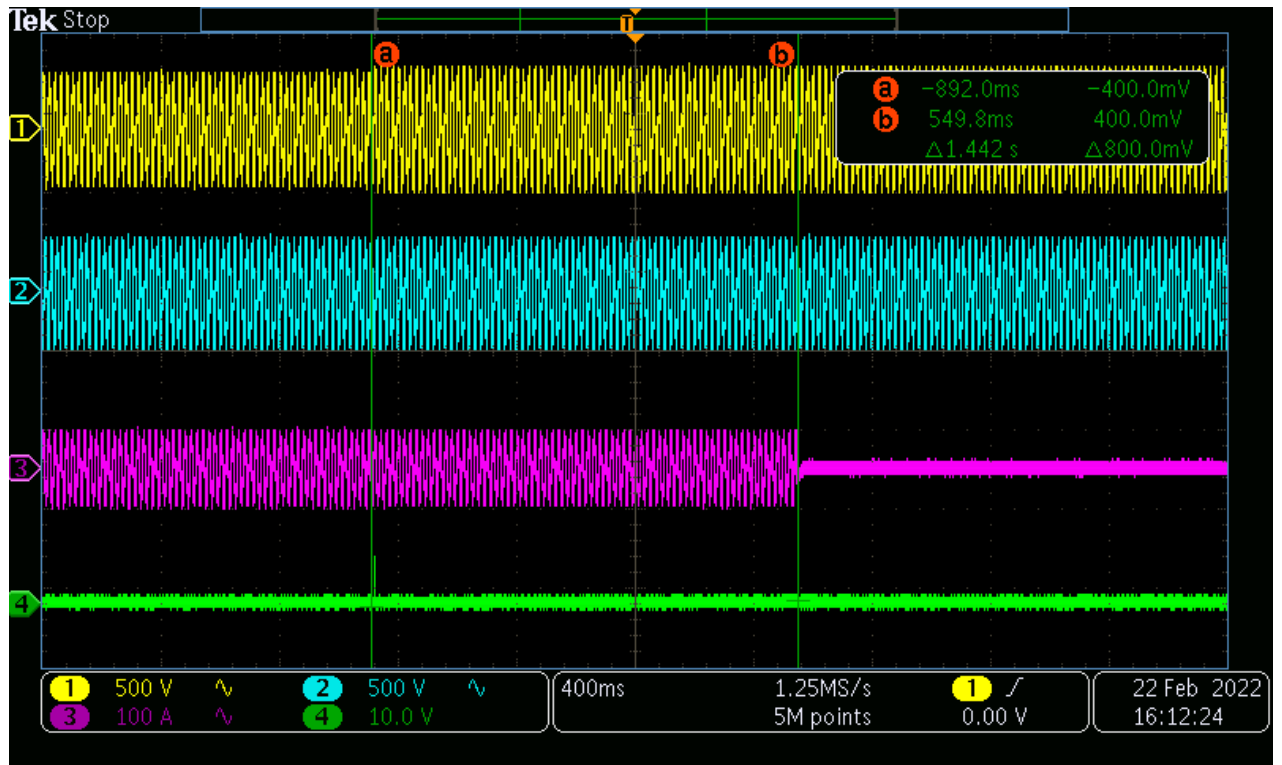

Phase A of Test 3

Trip Value

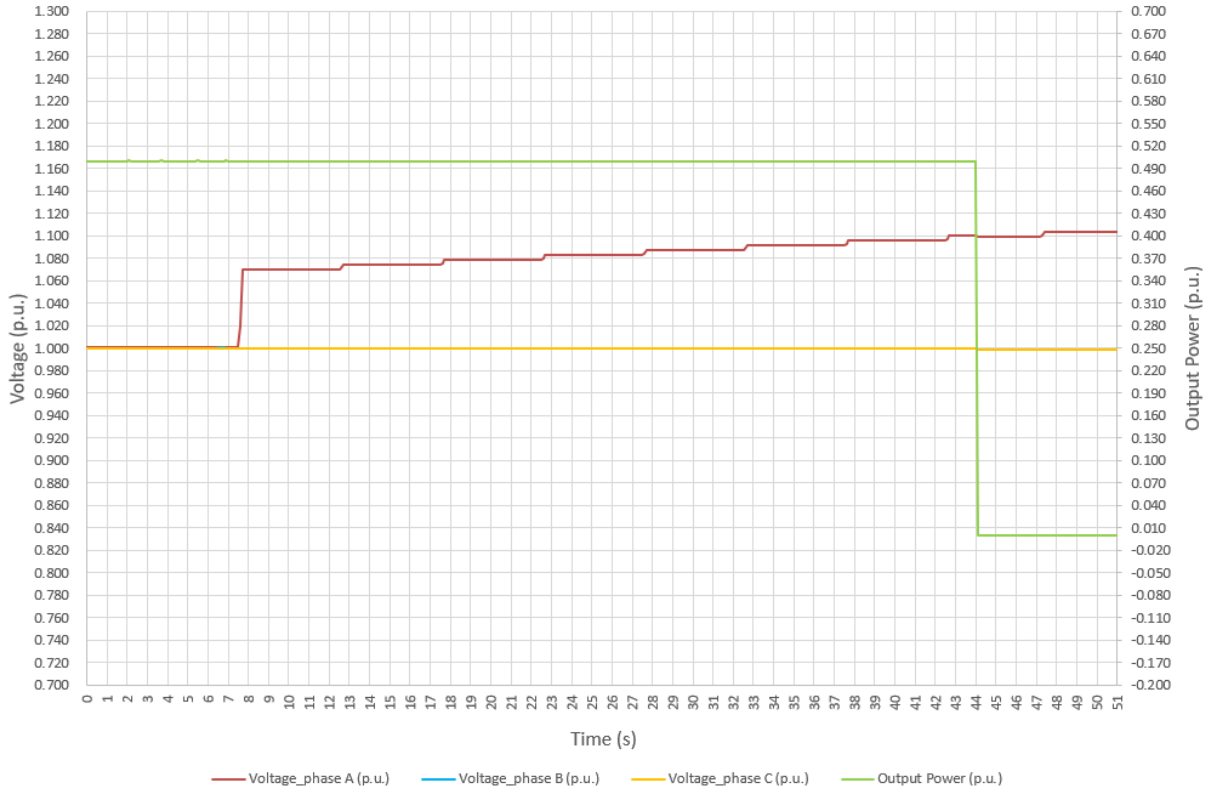

Trip Time

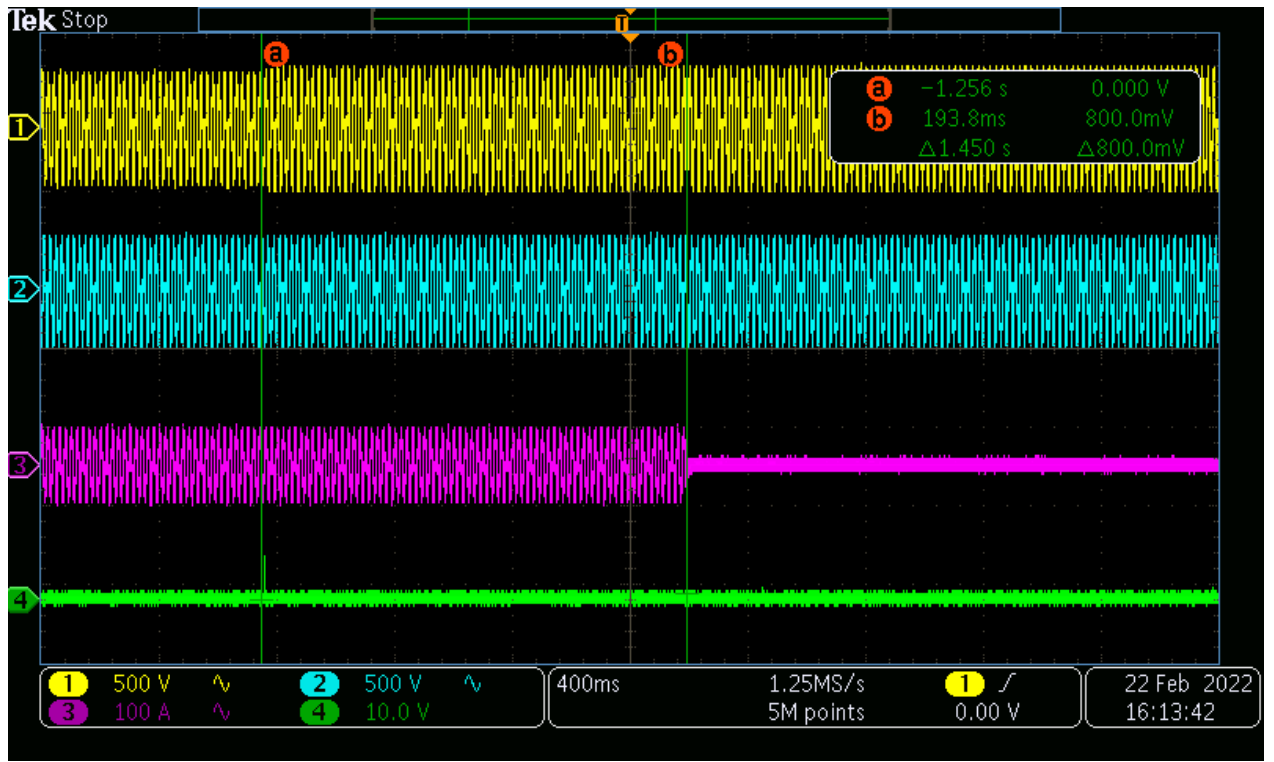

Phase B of Test 1

Trip Value

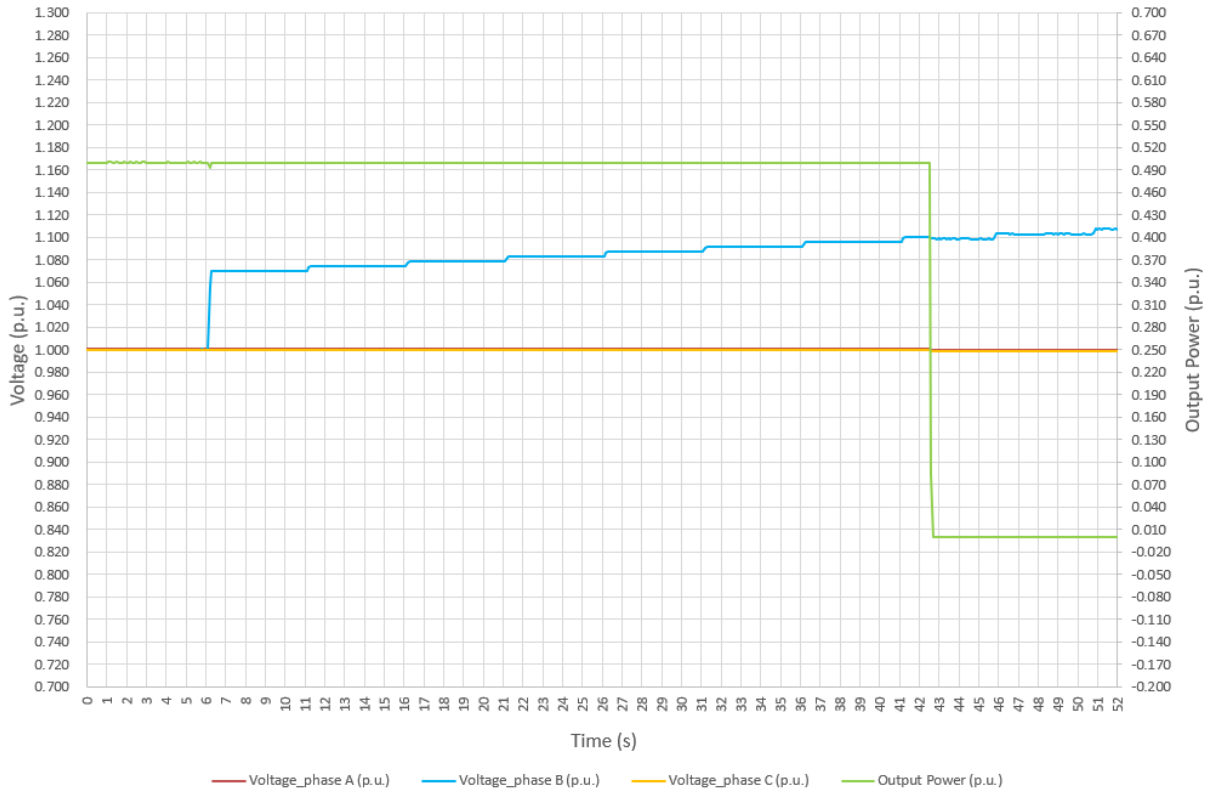

Trip Time

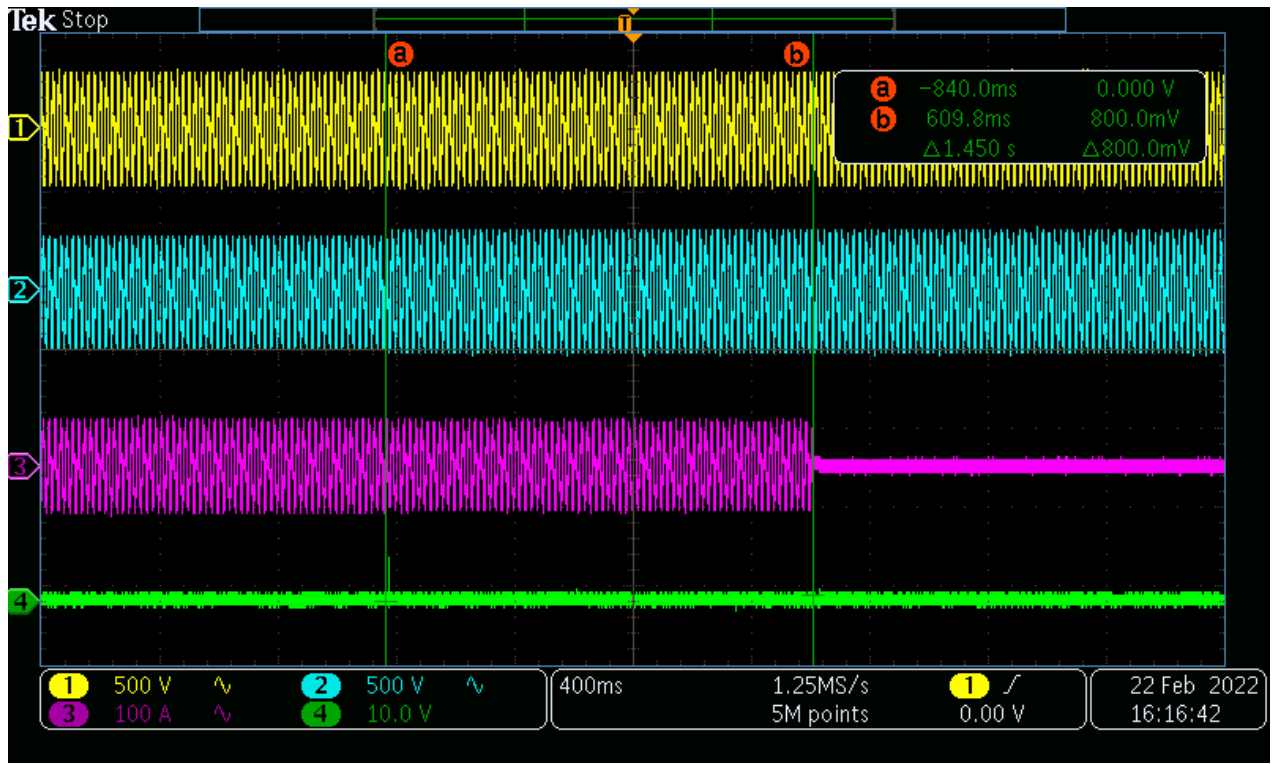

Phase B of Test 2

Trip Value

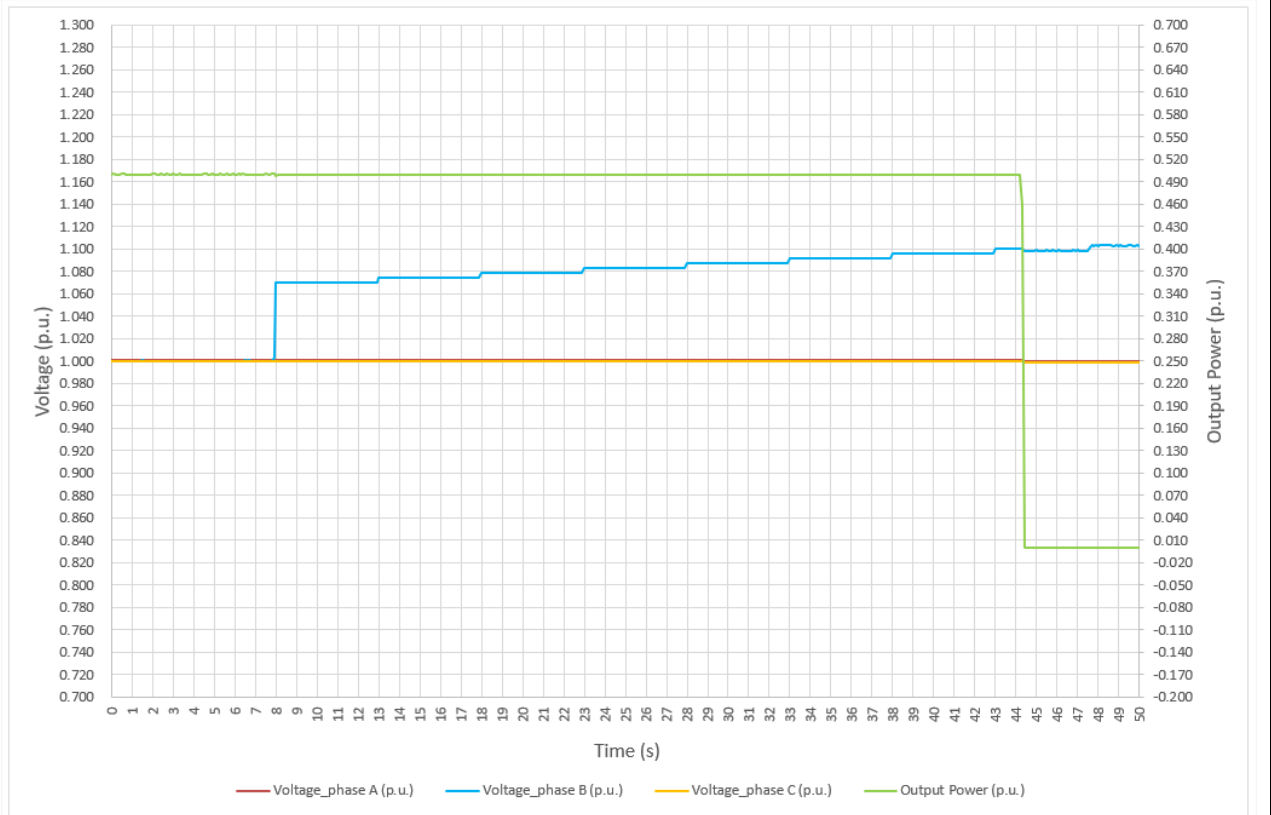

Trip Time

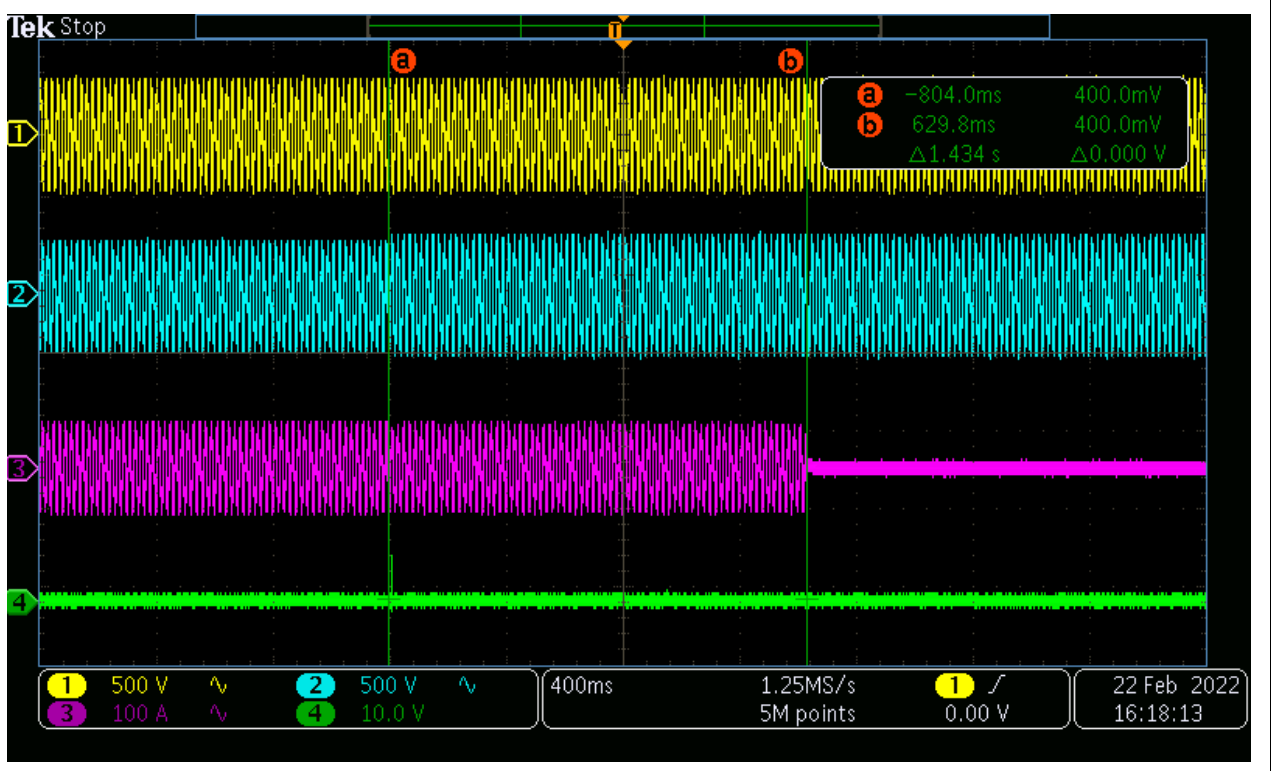

Phase B of Test 3

Trip Value

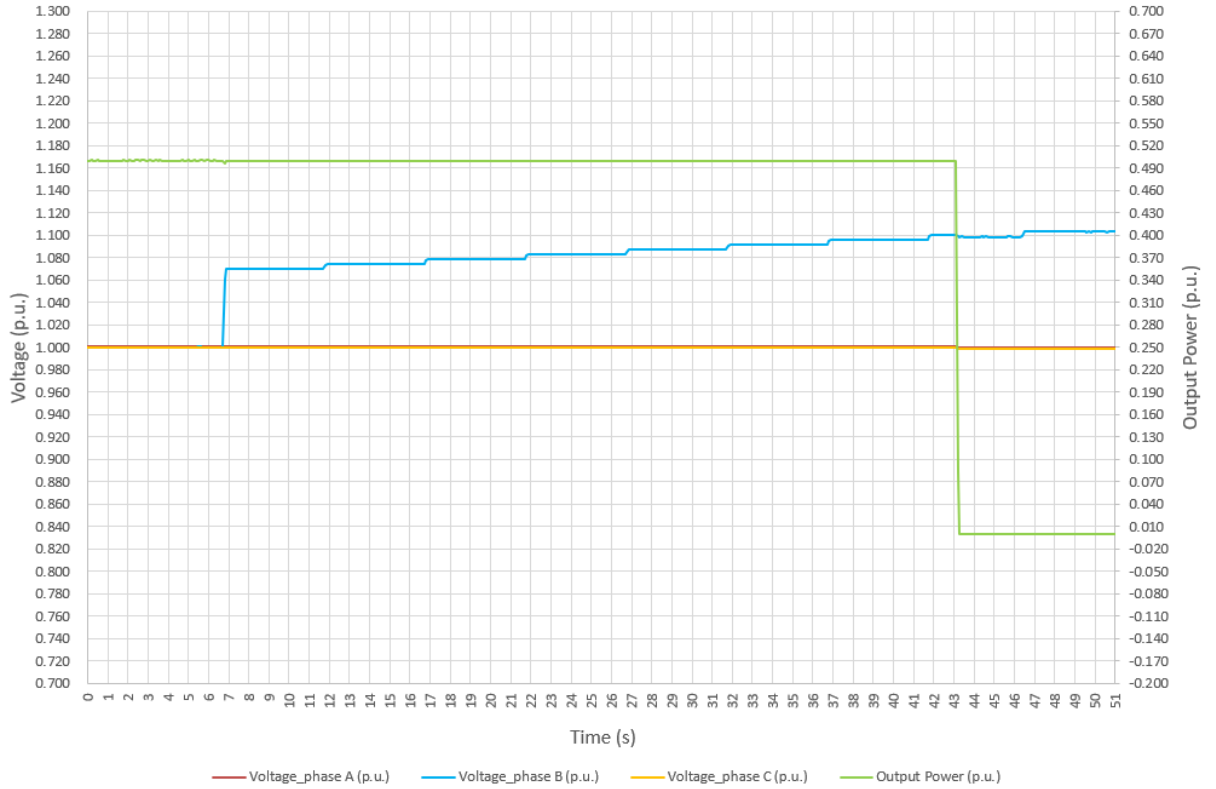

Trip Time

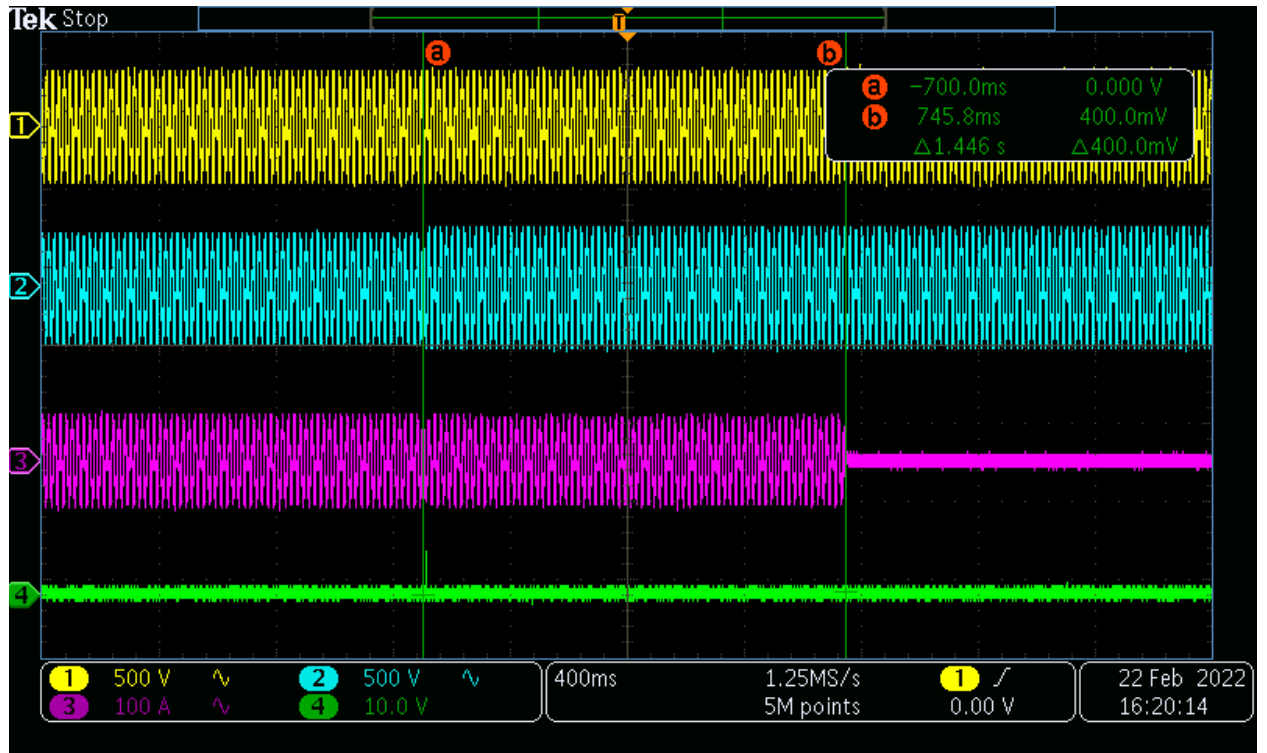

Phase C of Test 1

Trip Value

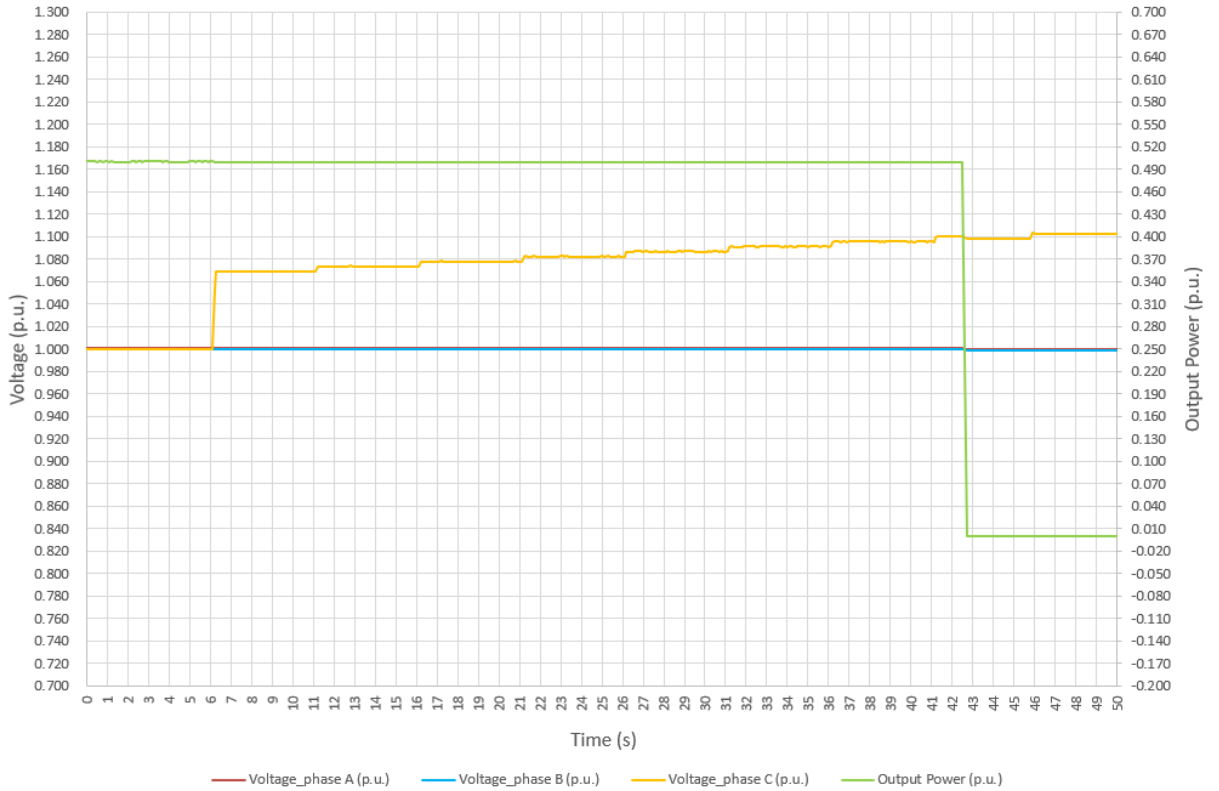

Trip Time

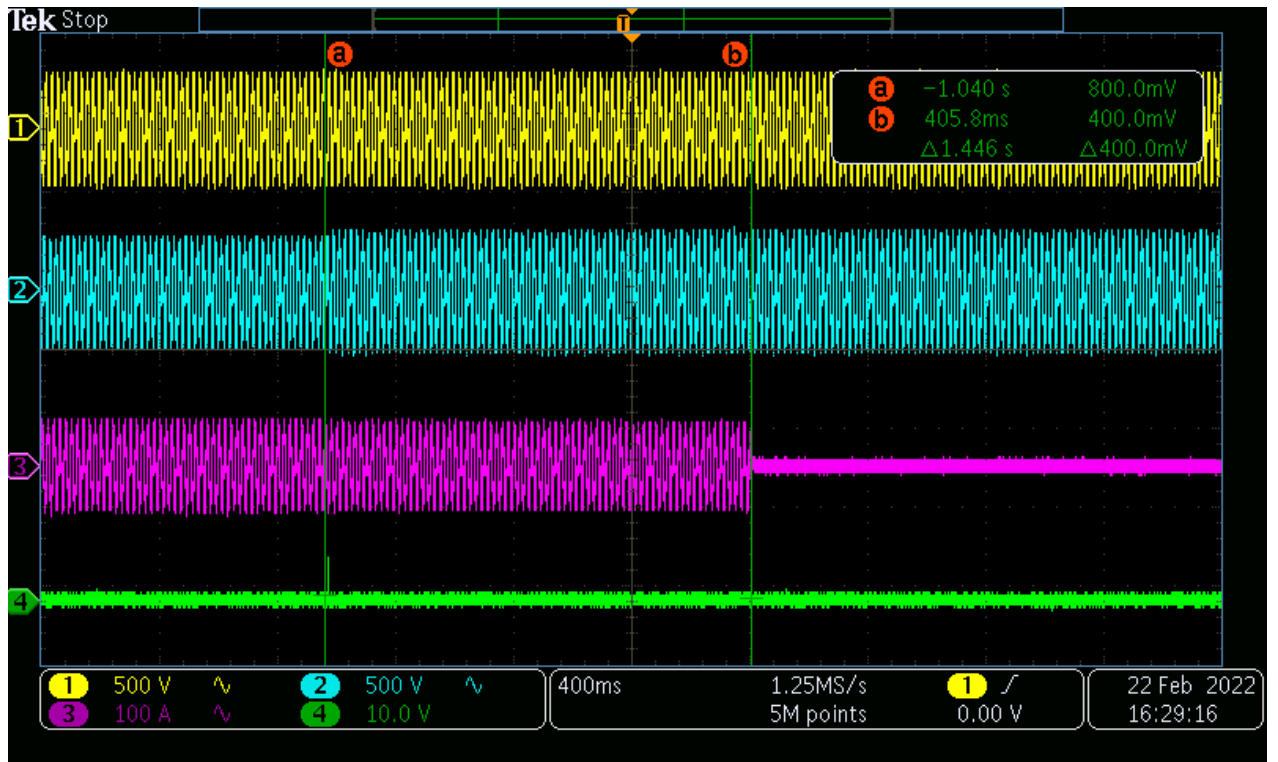

Phase C of Test 2

Trip Value

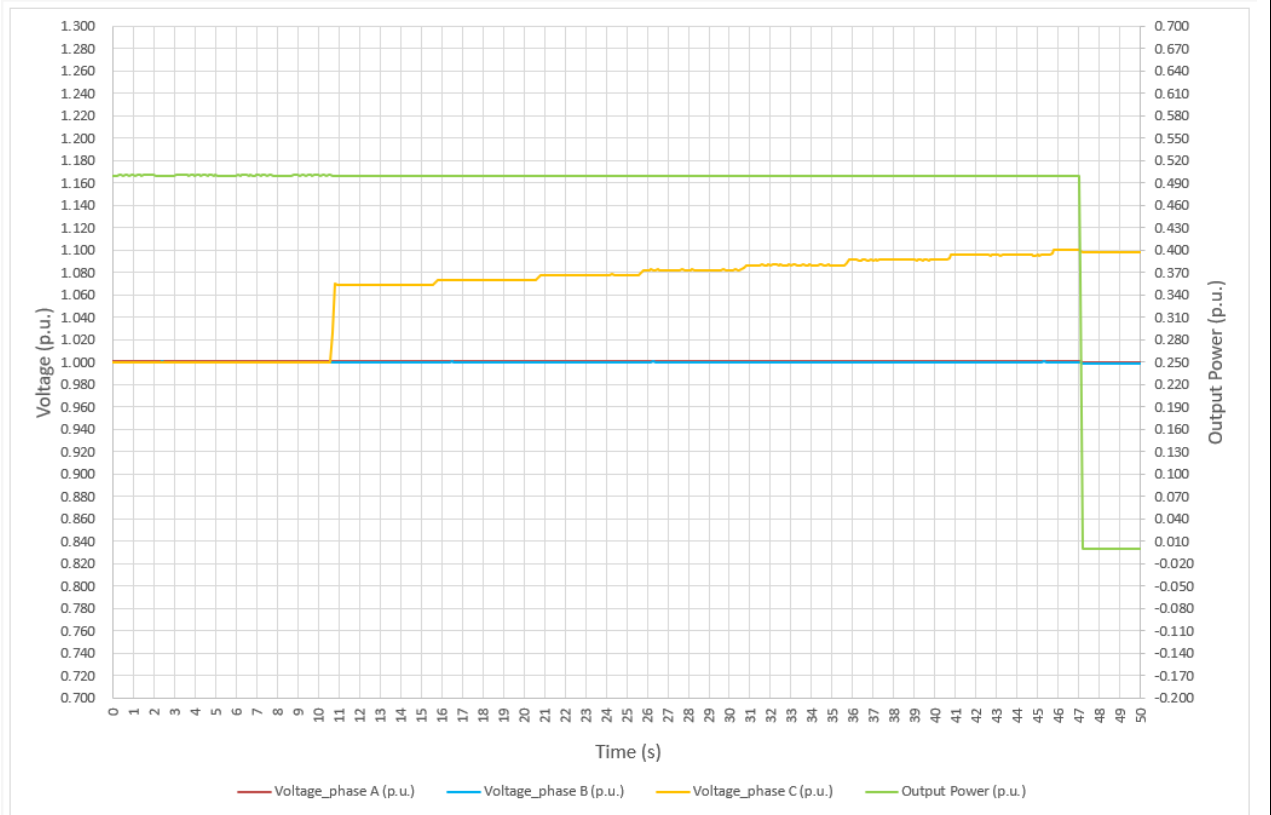

Trip Time

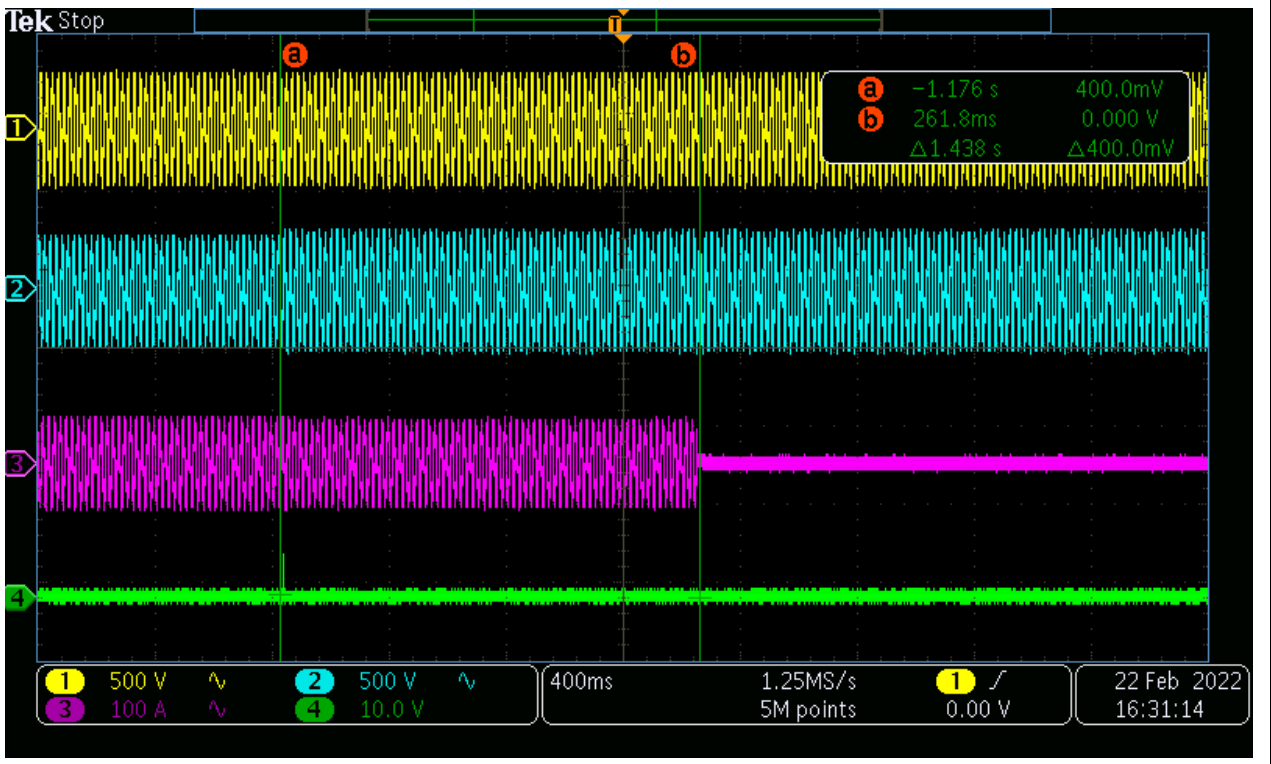



Phase C of Test 3

Trip Value

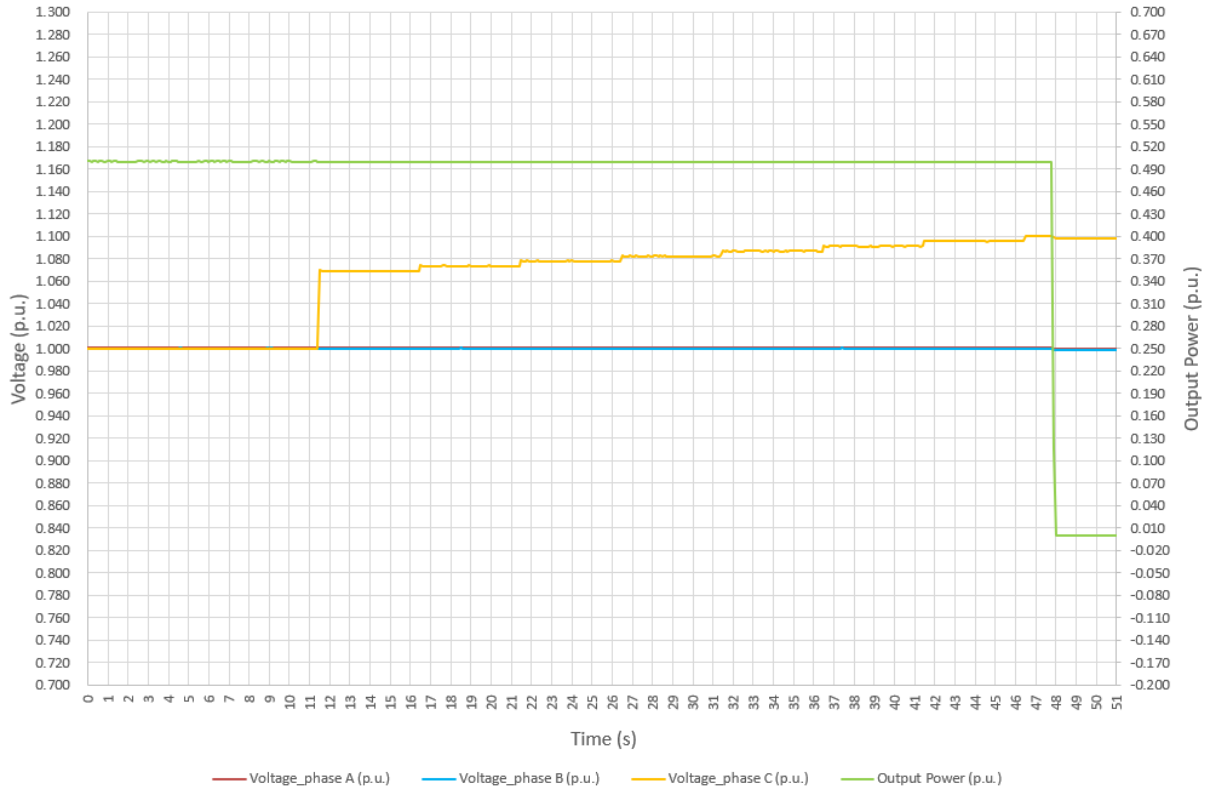

Trip Time

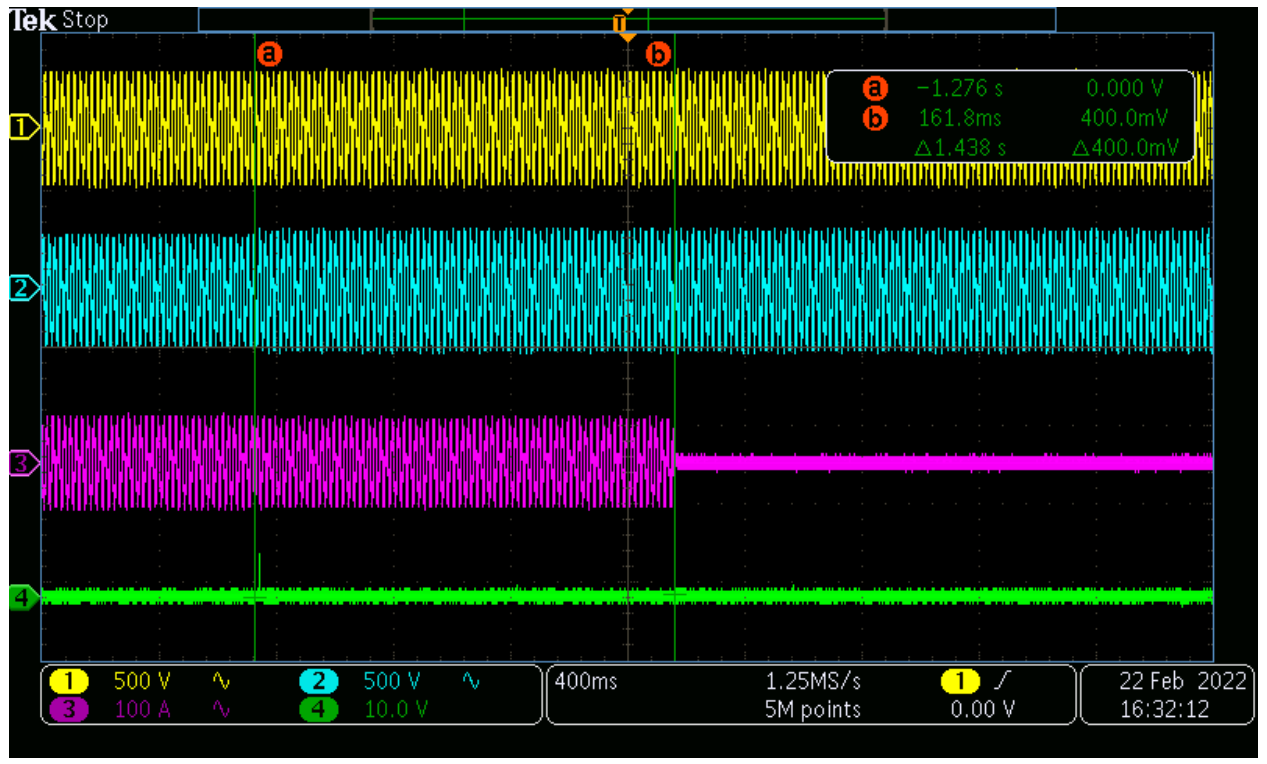

Phase ABC of Test 1

Trip Value

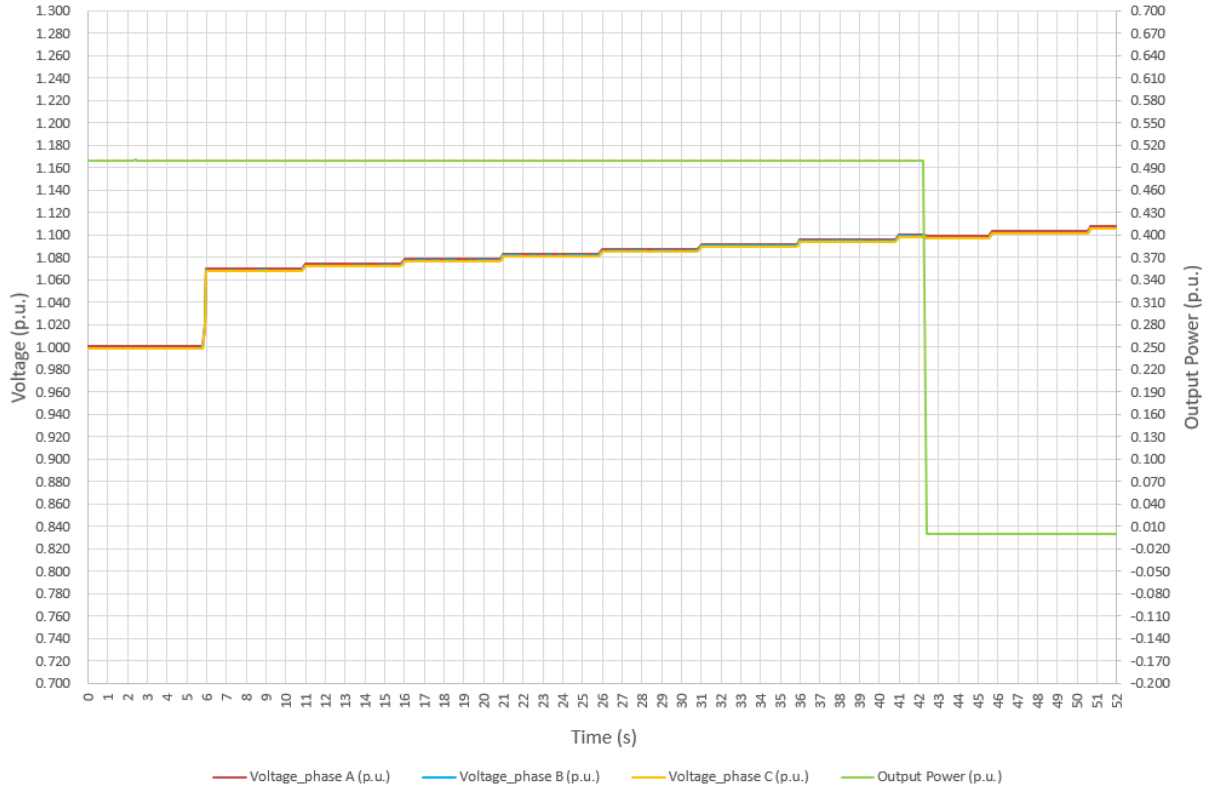

Trip Time

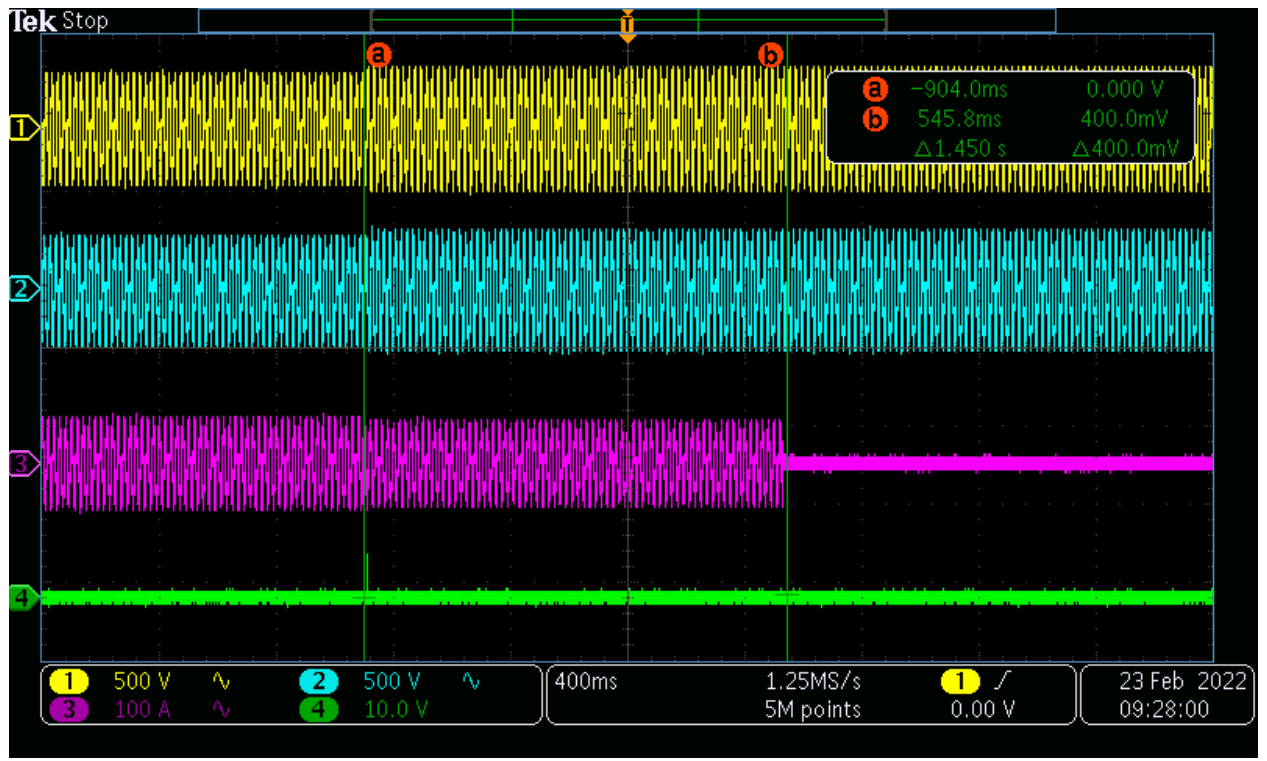

Phase ABC of Test 2

Trip Value

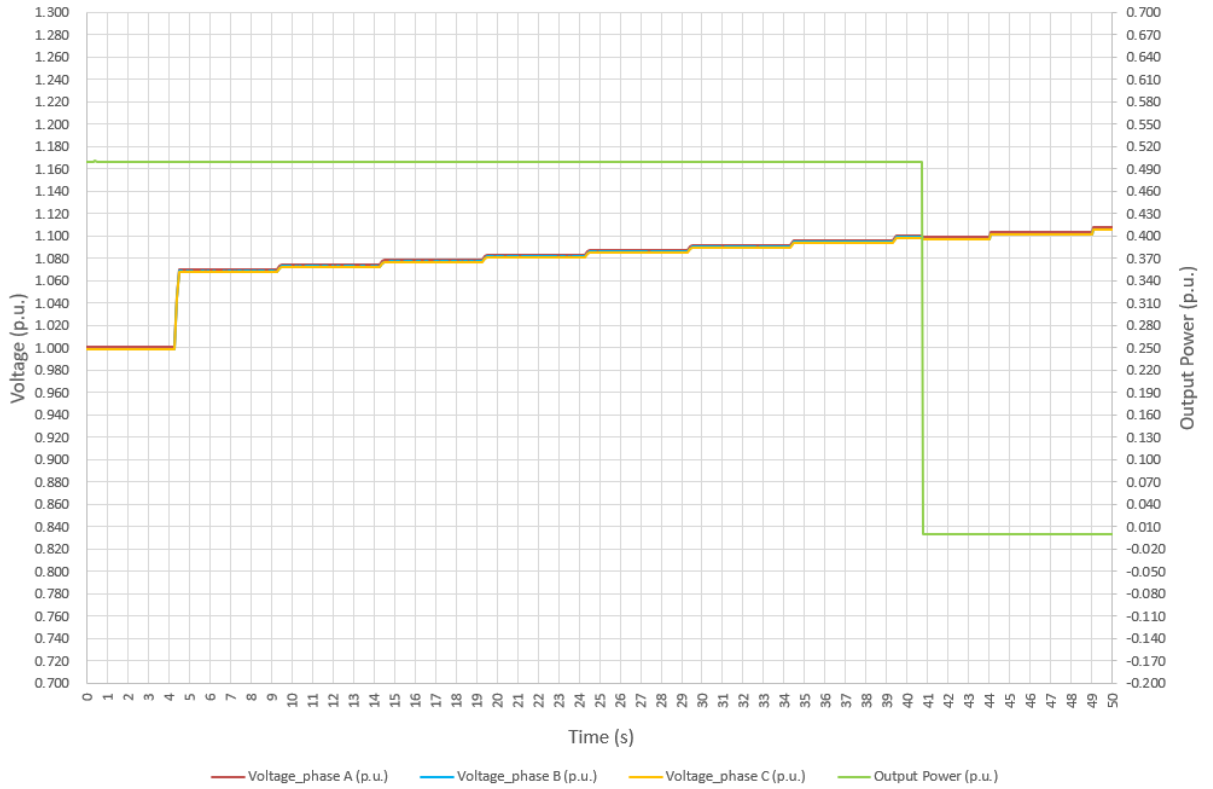

Trip Time

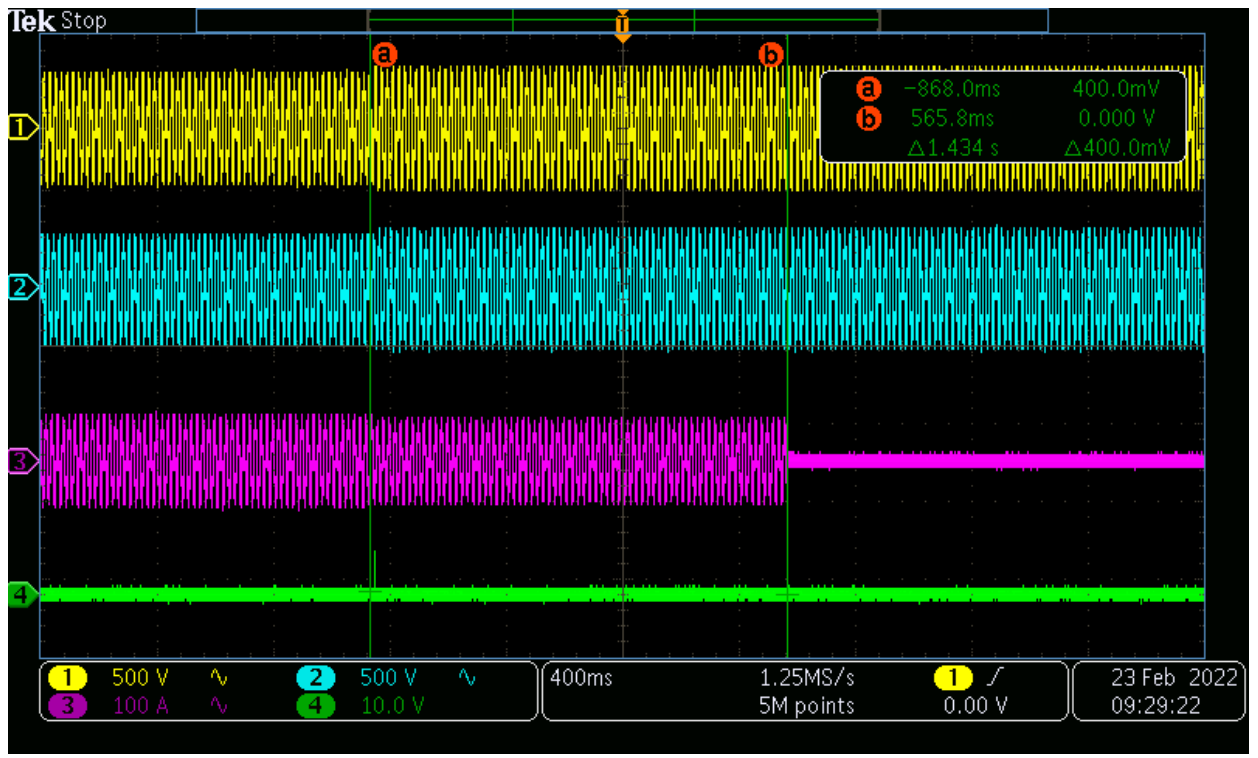

Phase ABC of Test 3

Trip Value

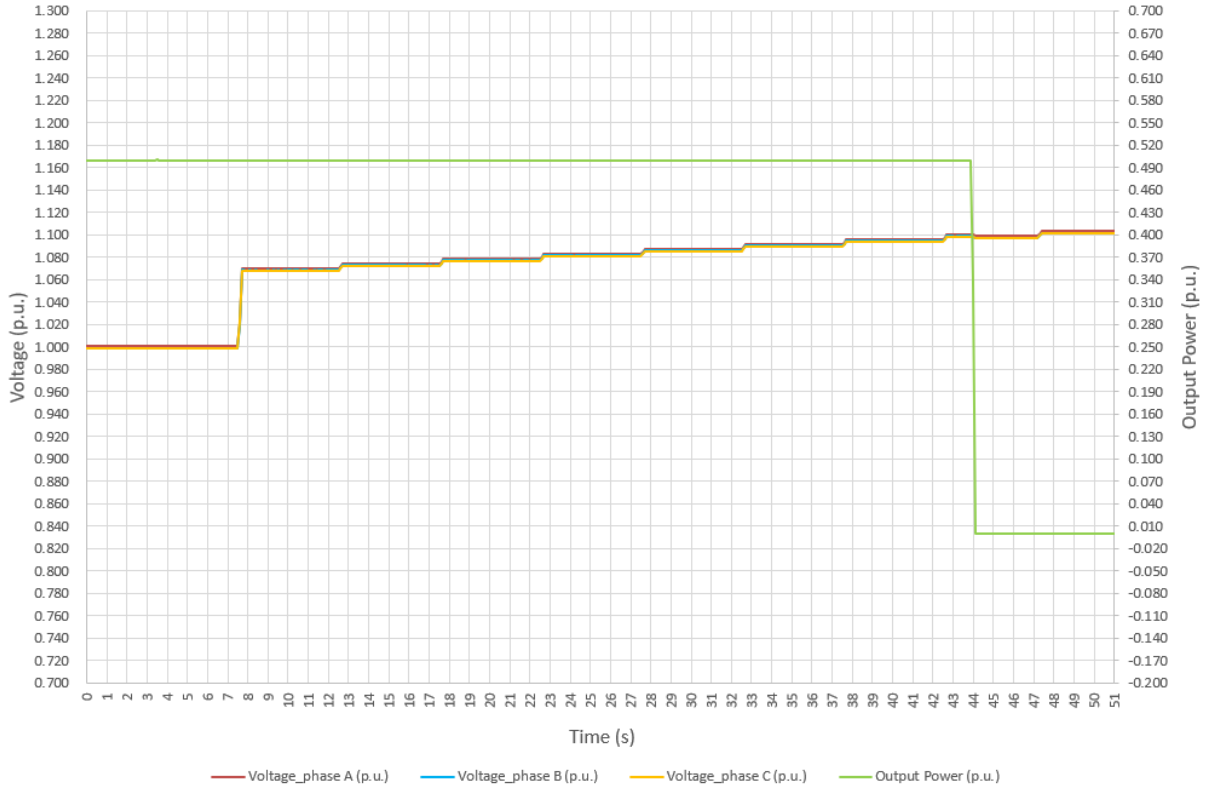

Trip Time

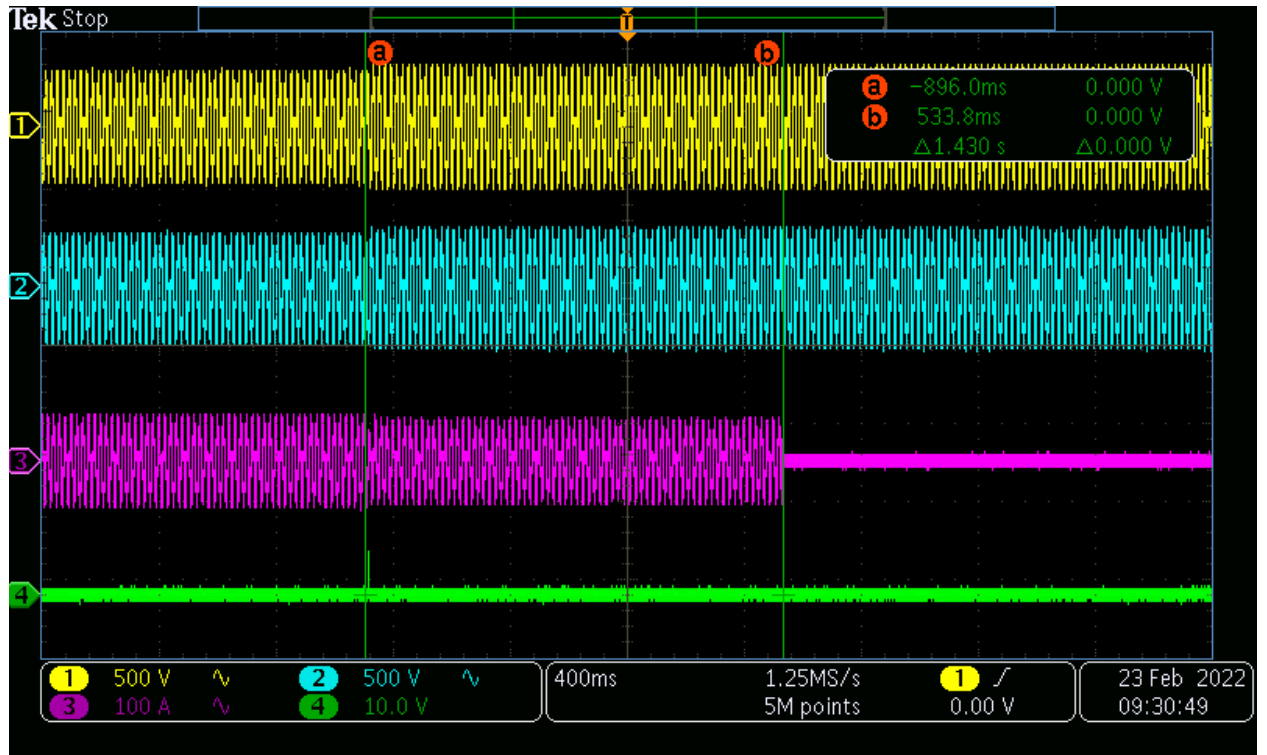

**4.6.3.3 Underfrequency protection (Country / Region: The Netherlands)**

50Hz - 4%				
Parameter	Settings	Test 1	Test 2	Test 3
Trip value [Hz]	48.00	48.01	47.99	47.99
Trip time [s]	< 2.000	1.640	1.625	1.635

Test results are represented at diagrams below.

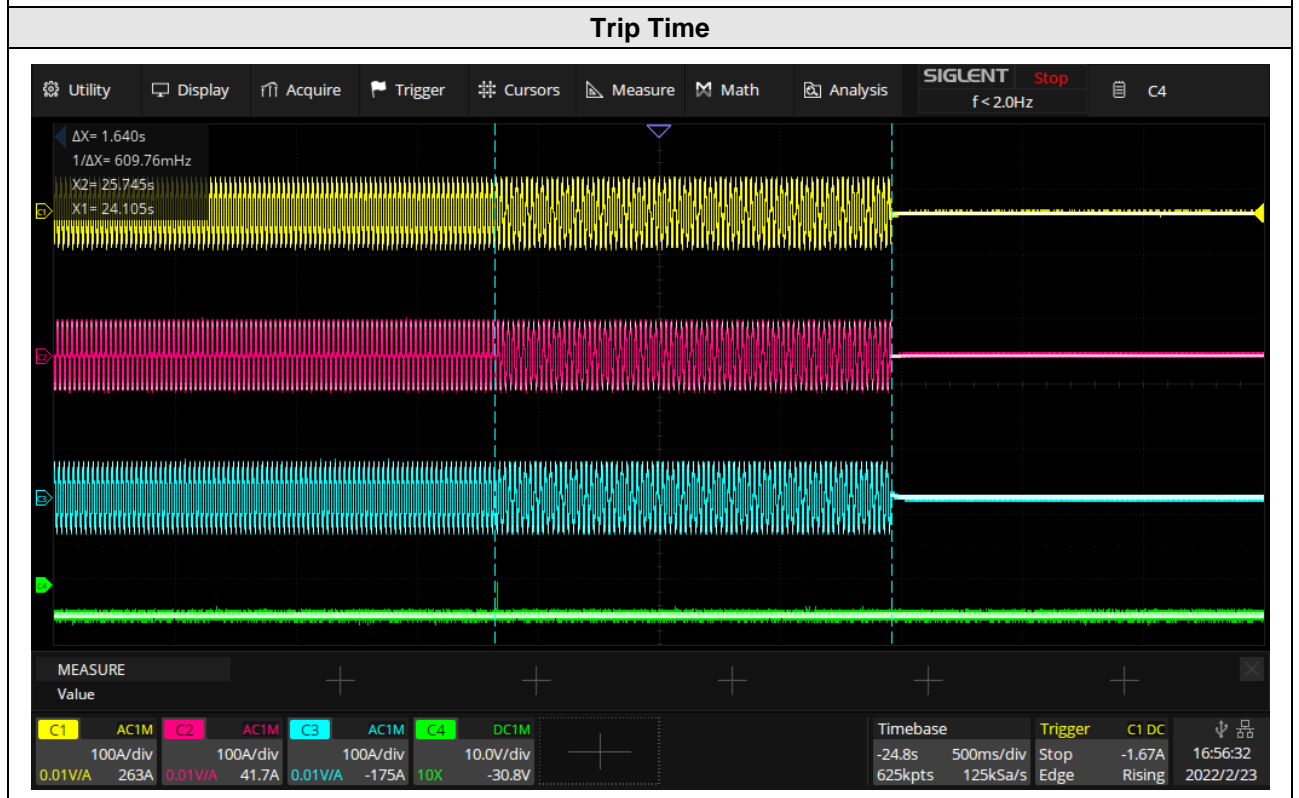
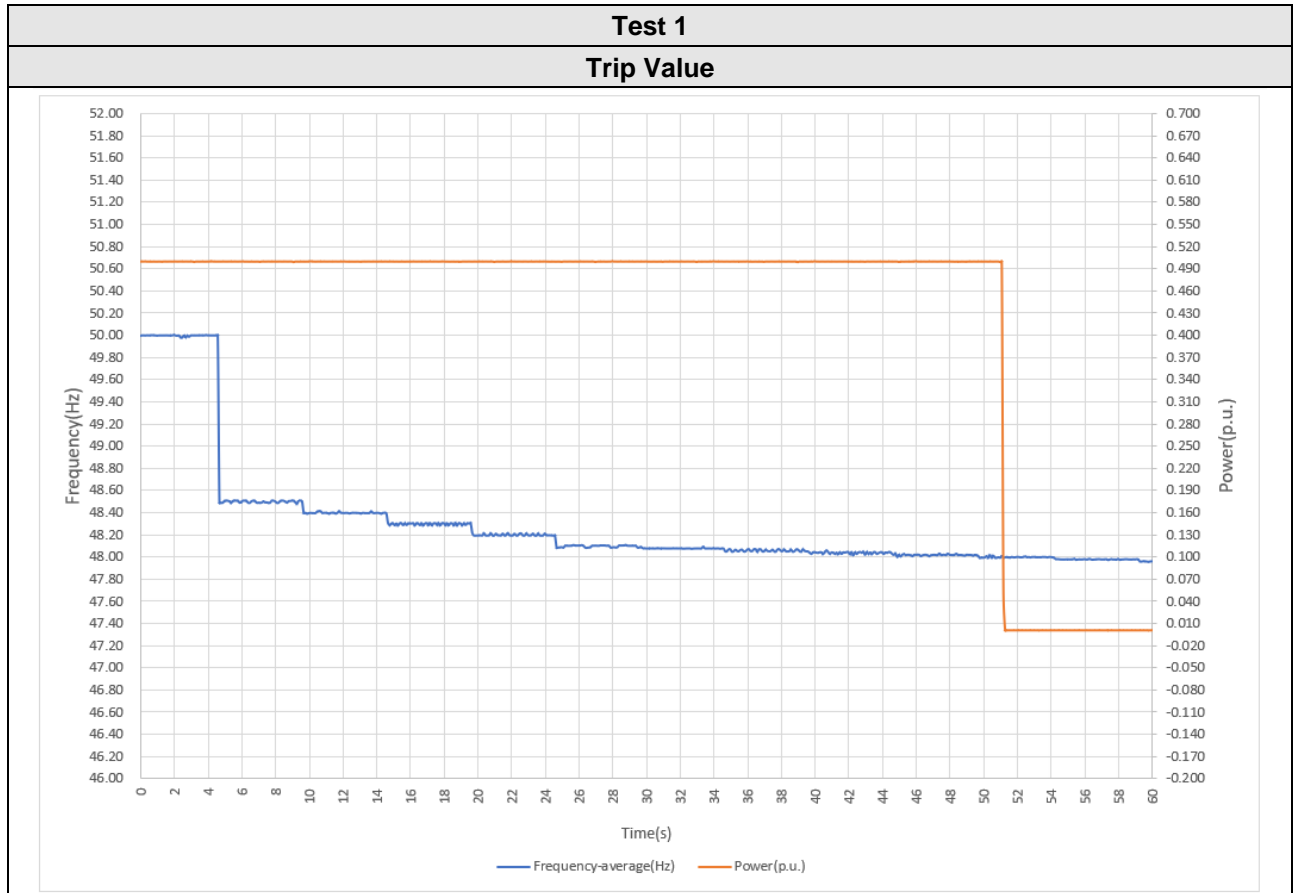

Test 2

Trip Value

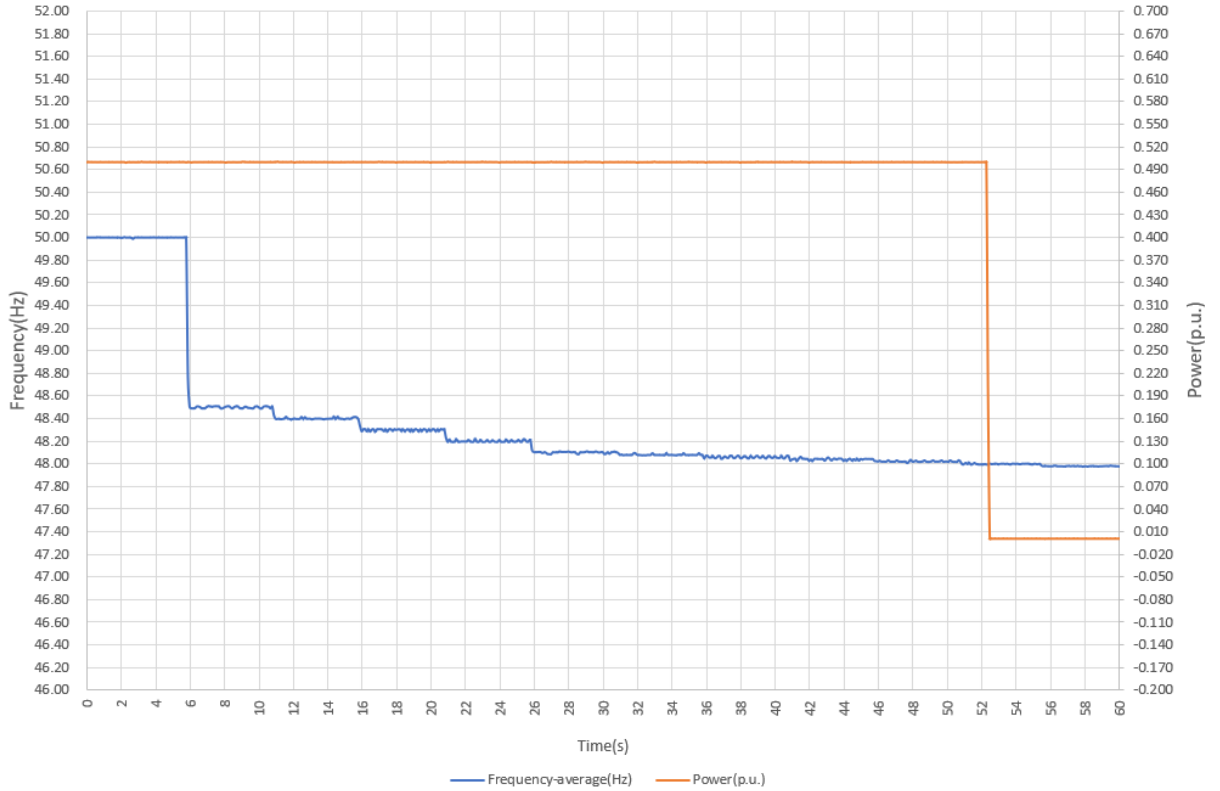

Trip Time

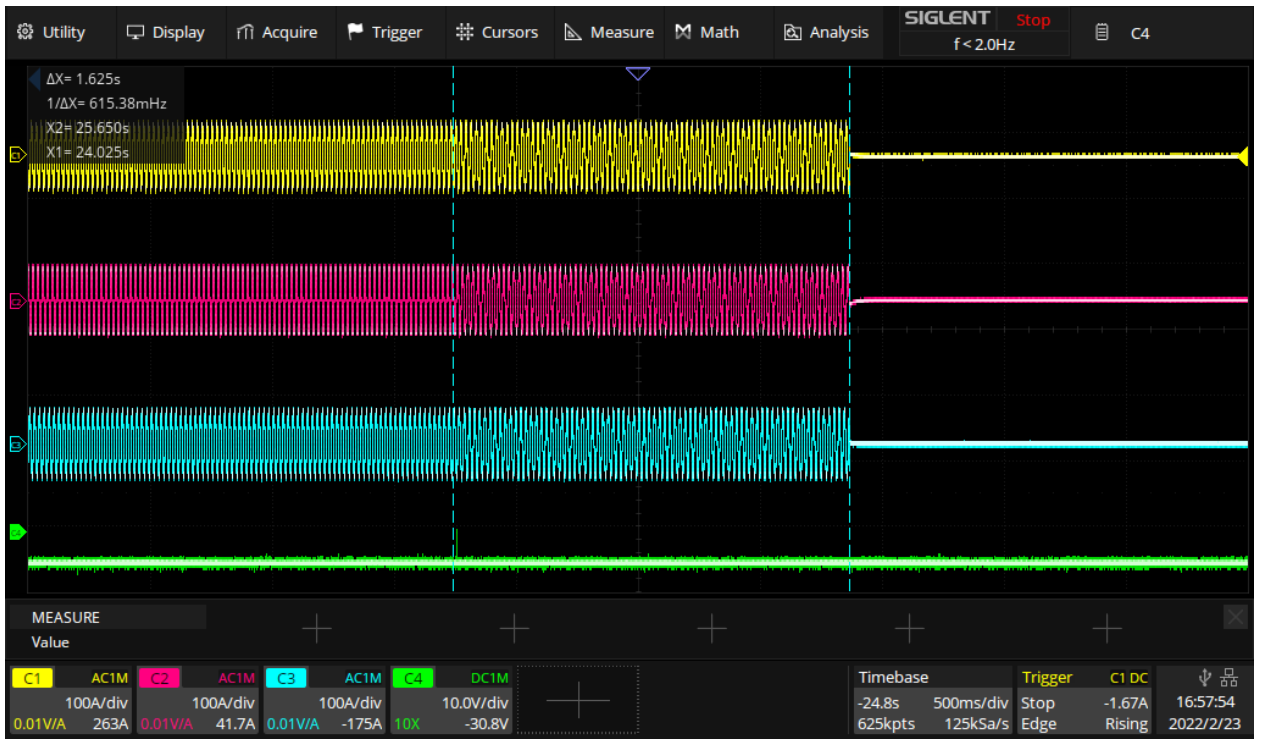

Test 3

Trip Value

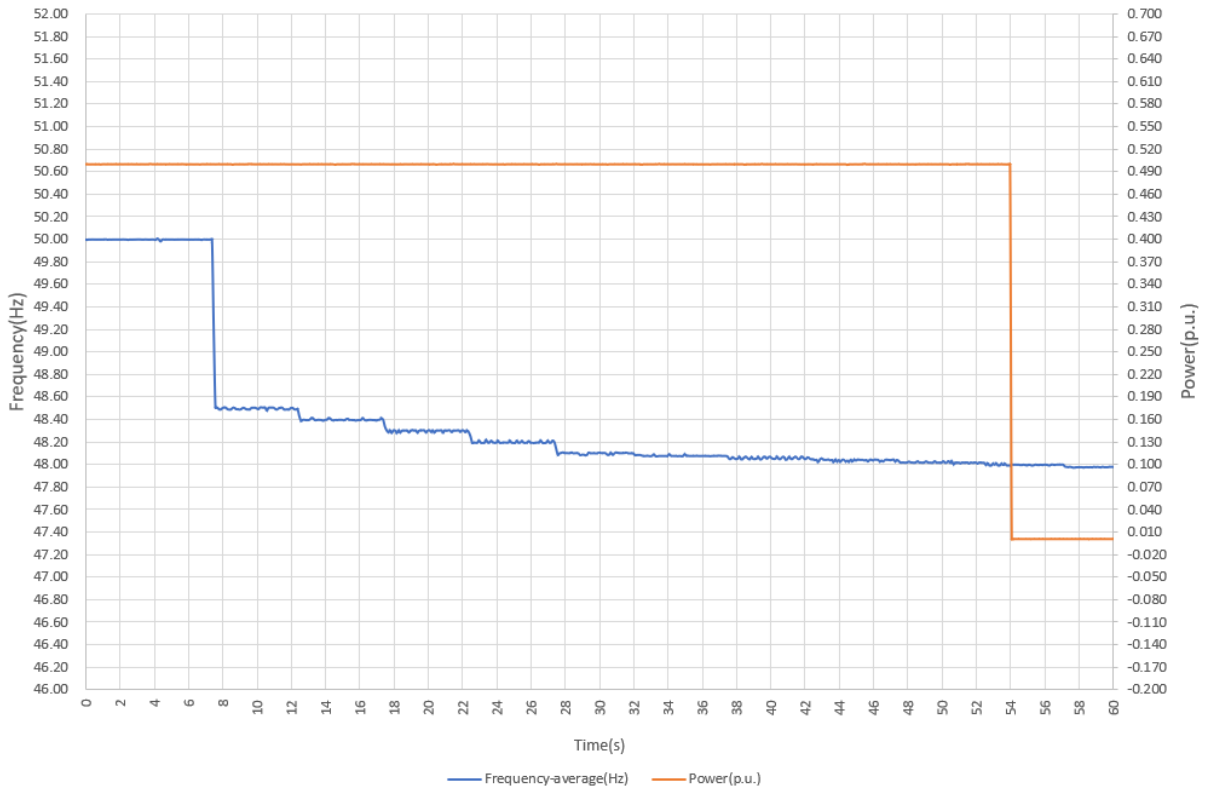

Trip Time

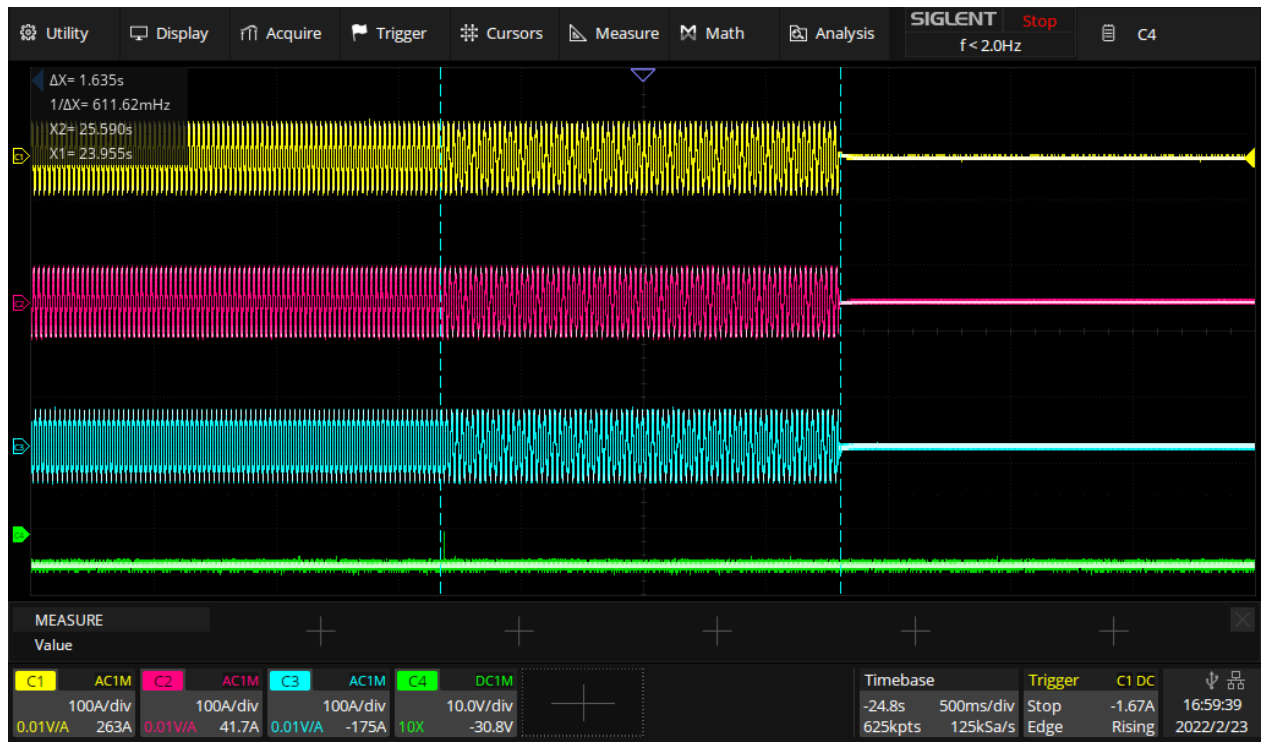



**4.6.3.4 Overfrequency protection (Country / Region: The Netherlands)**

50Hz +2%				
Parameter	Settings	Test 1	Test 2	Test 3
Trip value [Hz]	51.00	50.99	51.00	51.01
Trip time [s]	< 2.000	1.638	1.654	1.634

Test results are represented at diagrams below.

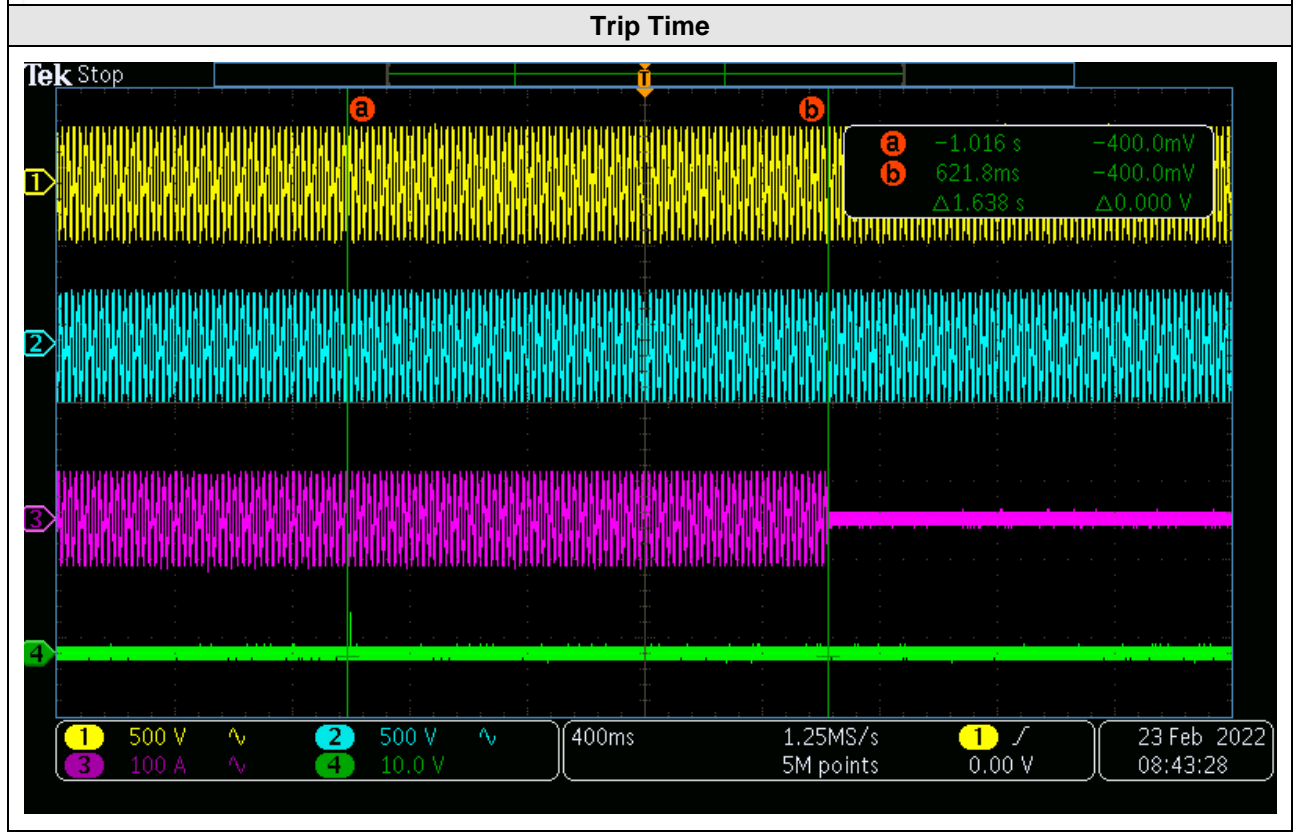
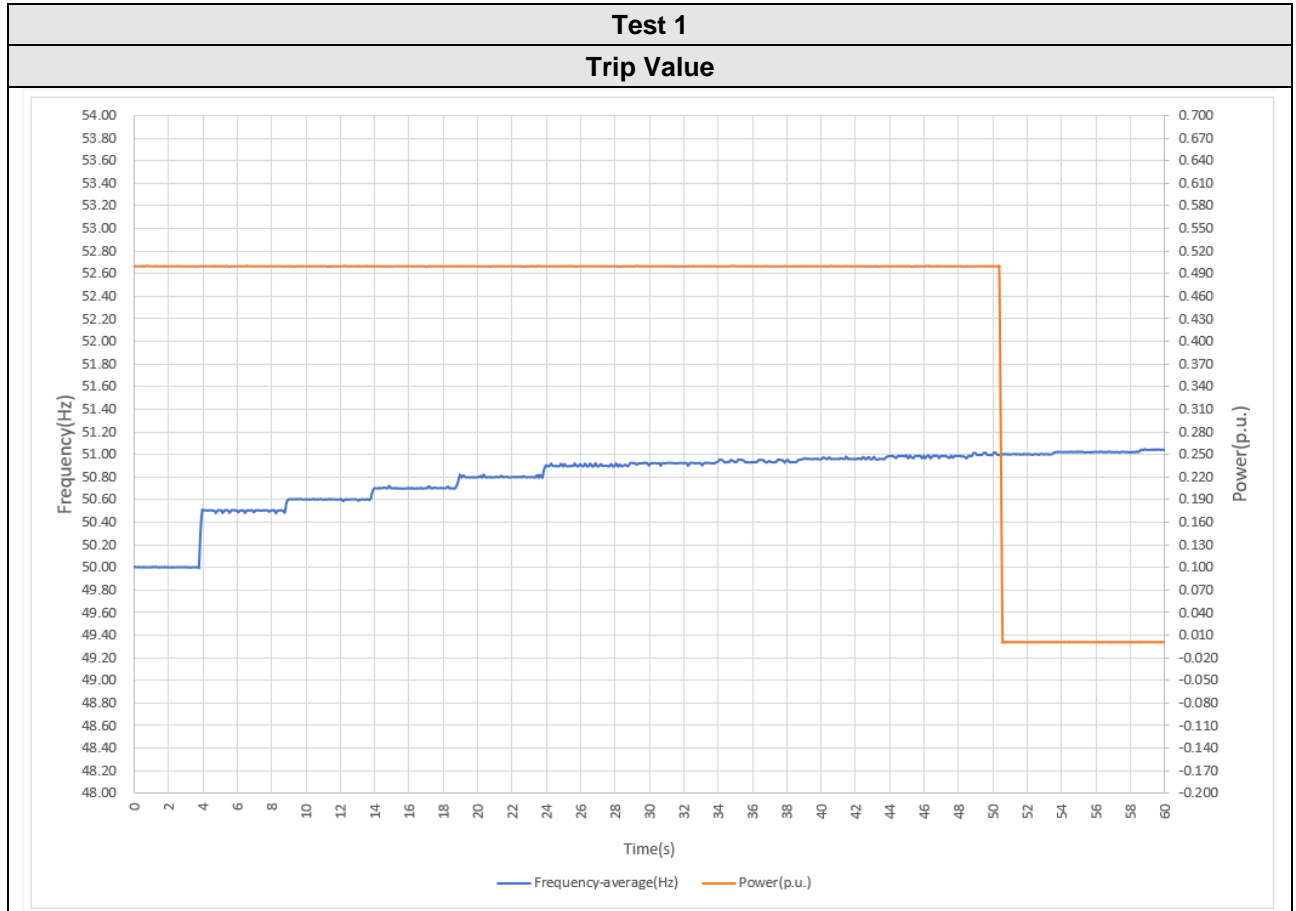

Test 2

Trip Value

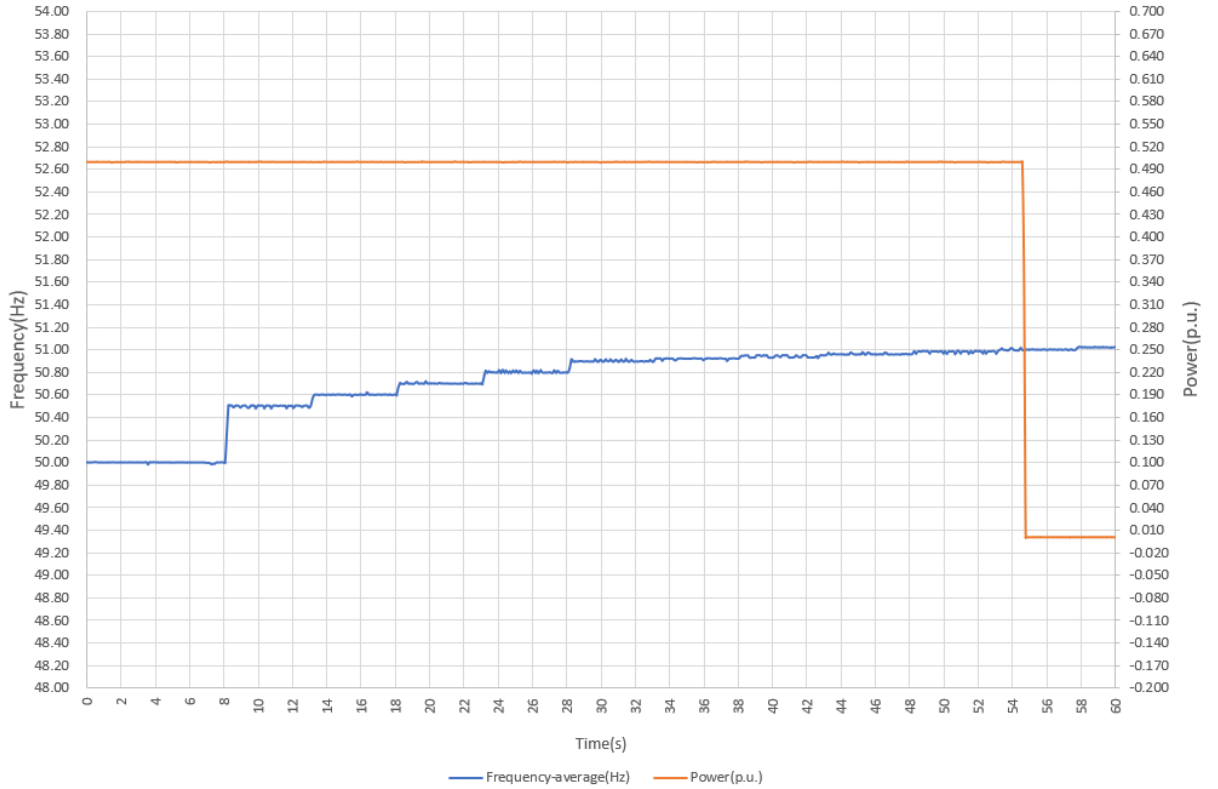

Trip Time

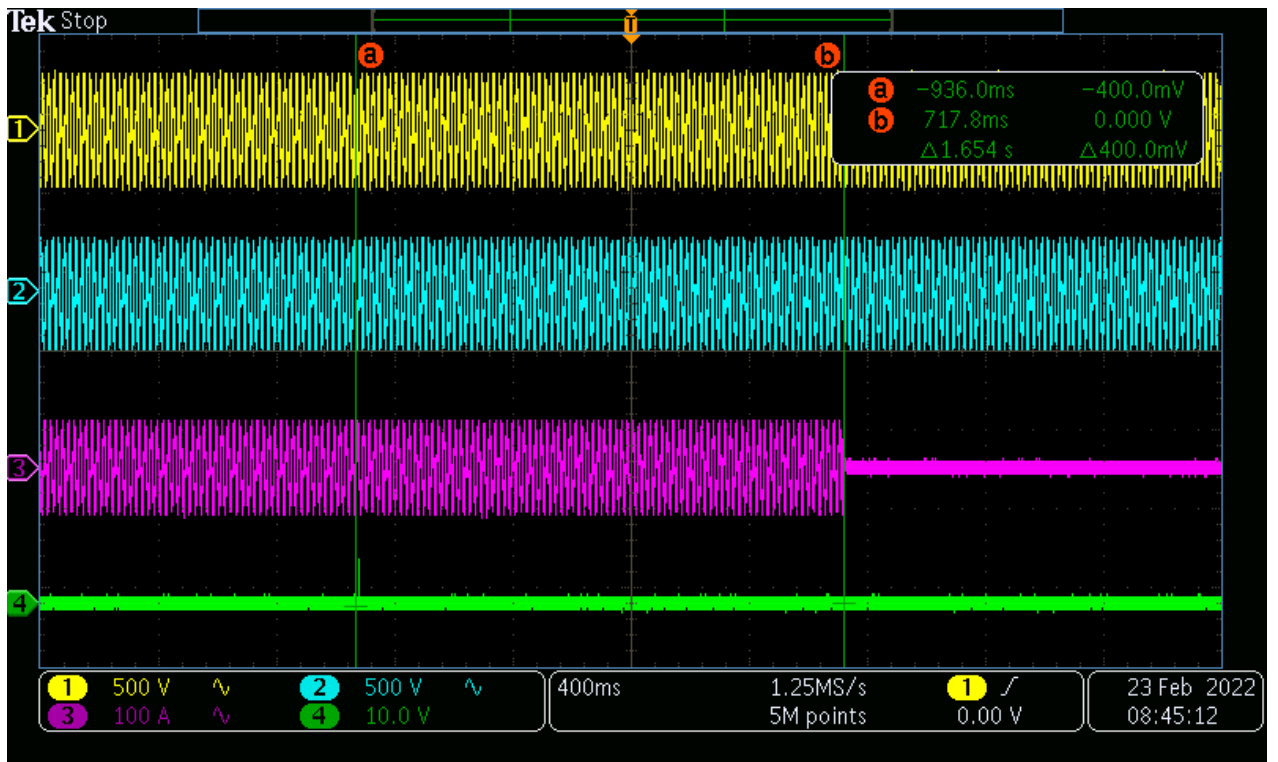

Test 3

Trip Value

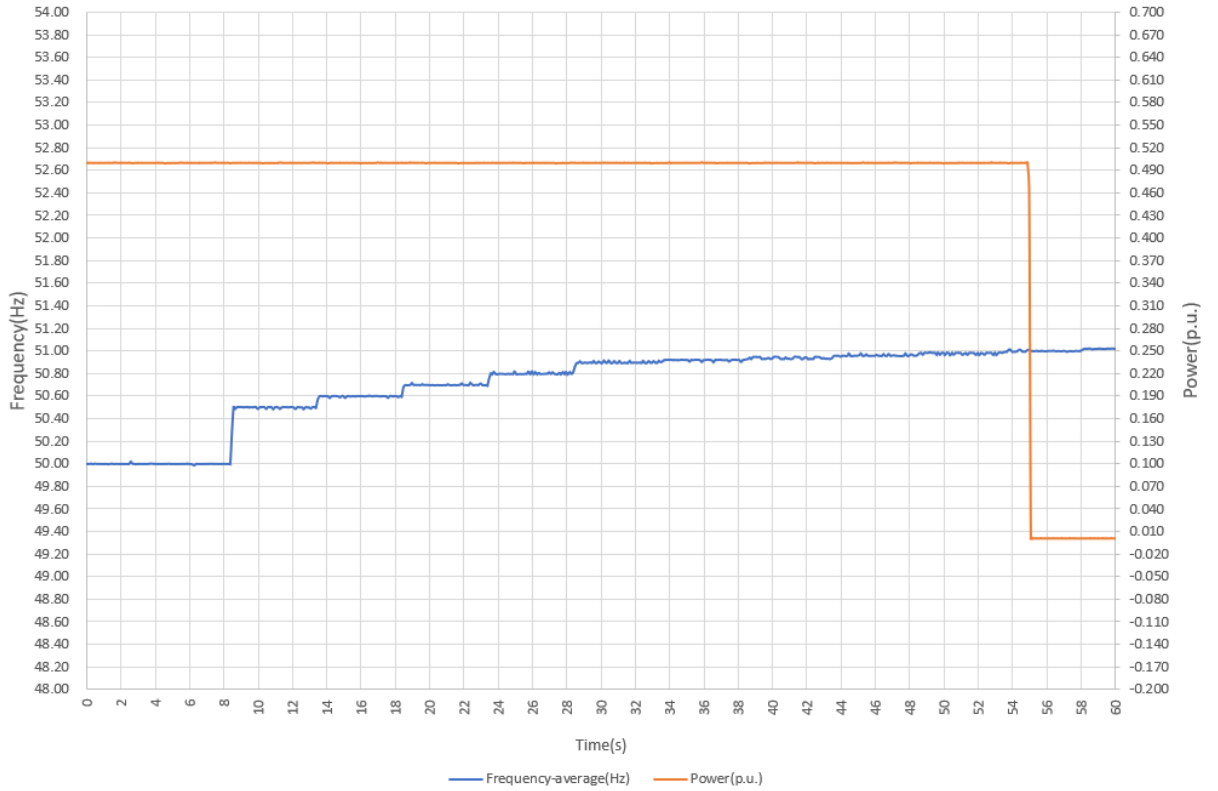

Trip Time

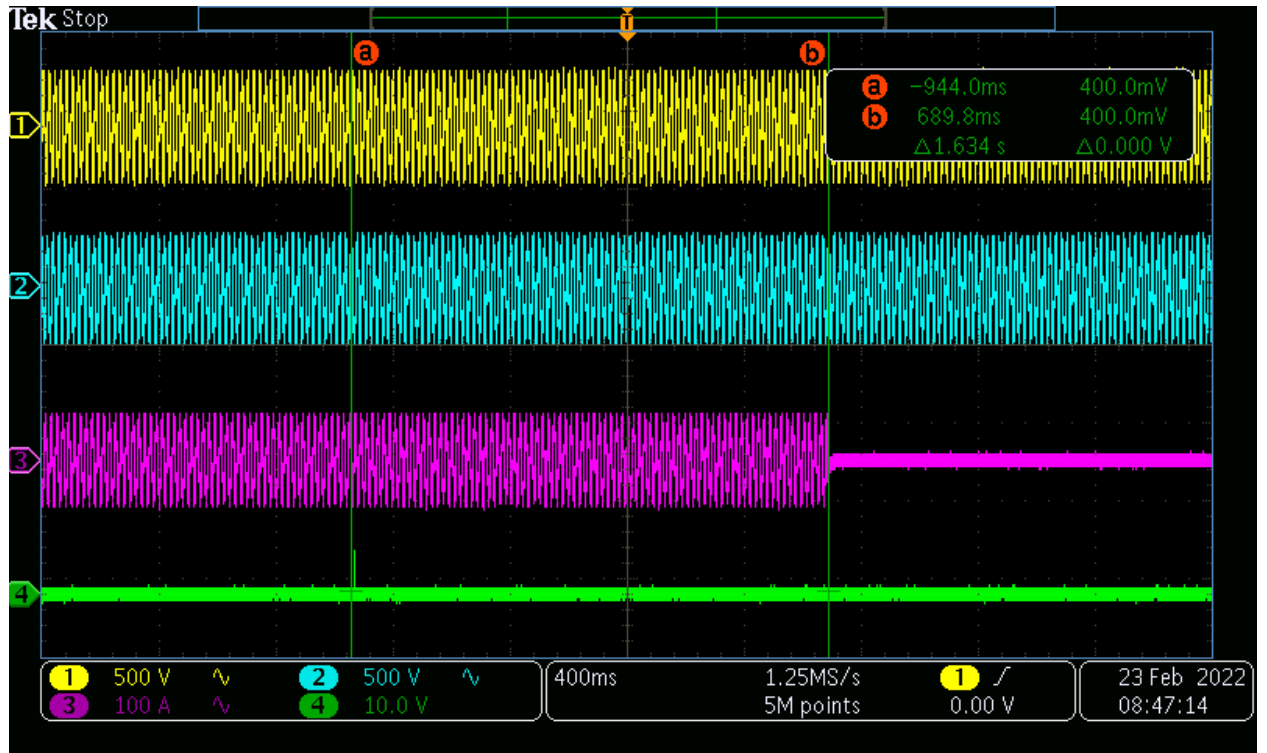

#### 4.6.4. Requirements on voltage and frequency protection (Country / Region included in the default settings: Poland)

Add test **A.18 PL – Poland** for interface protection according to chapter 4.6.2 and Table 4 of the standard EN 50438: 2013 as following:

Parameter	Maximum disconnection time	Minimum operate time	Trip value
Over-voltage – stage 1 <sup>a</sup>	3 s	-	230 V + 10 %
Over-voltage – stage 2	0.2 s	0.1 s	230 V + 15 %
Under-voltage	1.5 s	1.2 s	230 V – 15 %
Over-frequency	0.5 s	0.3 s	52 Hz
Under-frequency	0.5 s	0.3 s	47.5 Hz
LoM (if required)	See Annex A		See Annex A.
The stated voltages are 'true r.m.s.' or fundamental component -values.			
<sup>a</sup> Over-voltage – stage 1: 10-min-value corresponding to EN 50160. The calculation of the 10 min value shall comply with the 10 min aggregation of EN 61000-4-30, class S. The function shall be based on the calculation of the square root of the arithmetic mean of the squared input values over 10 min. In deviation from EN 61000-4-30, a moving window shall be used. The calculation of a new 10-min value at least every 3 s is sufficient, which is then to be compared with the trip value. Tolerances on disconnection time are $\pm 10\%$ .			

Note: Voltage and frequency is referenced to the supply terminals of the micro- generator.

The minimum required accuracy is:

- for frequency measurement  $\pm 0.05$  Hz;
- for voltage measurement  $\pm 1\%$  of  $U_n$ .

##### 4.6.4.1 Undervoltage protection (Country / Region: Poland)

Undervoltage of 85% $U_n$				
Phase A				
Parameter	Settings	Test 1	Test 2	Test 3
Trip value [V]	195.5	195.6	195.7	195.7
Trip time [s]	< 1.500	1.470	1.474	1.462
Phase B				
Parameter	Settings	Test 1	Test 2	Test 3
Trip value [V]	195.5	195.4	195.4	195.4
Trip time [s]	< 1.500	1.462	1.478	1.474
Phase C				
Parameter	Settings	Test 1	Test 2	Test 3
Trip value [V]	195.5	195.4	195.3	195.4
Trip time [s]	< 1.500	1.474	1.458	1.462
Phase ABC				
Parameter	Settings	Test 1	Test 2	Test 3
Trip value [V]	195.5	195.6	194.6	195.6
Trip time [s]	< 1.500	1.487	1.487	1.479

Test results are represented at diagrams below.

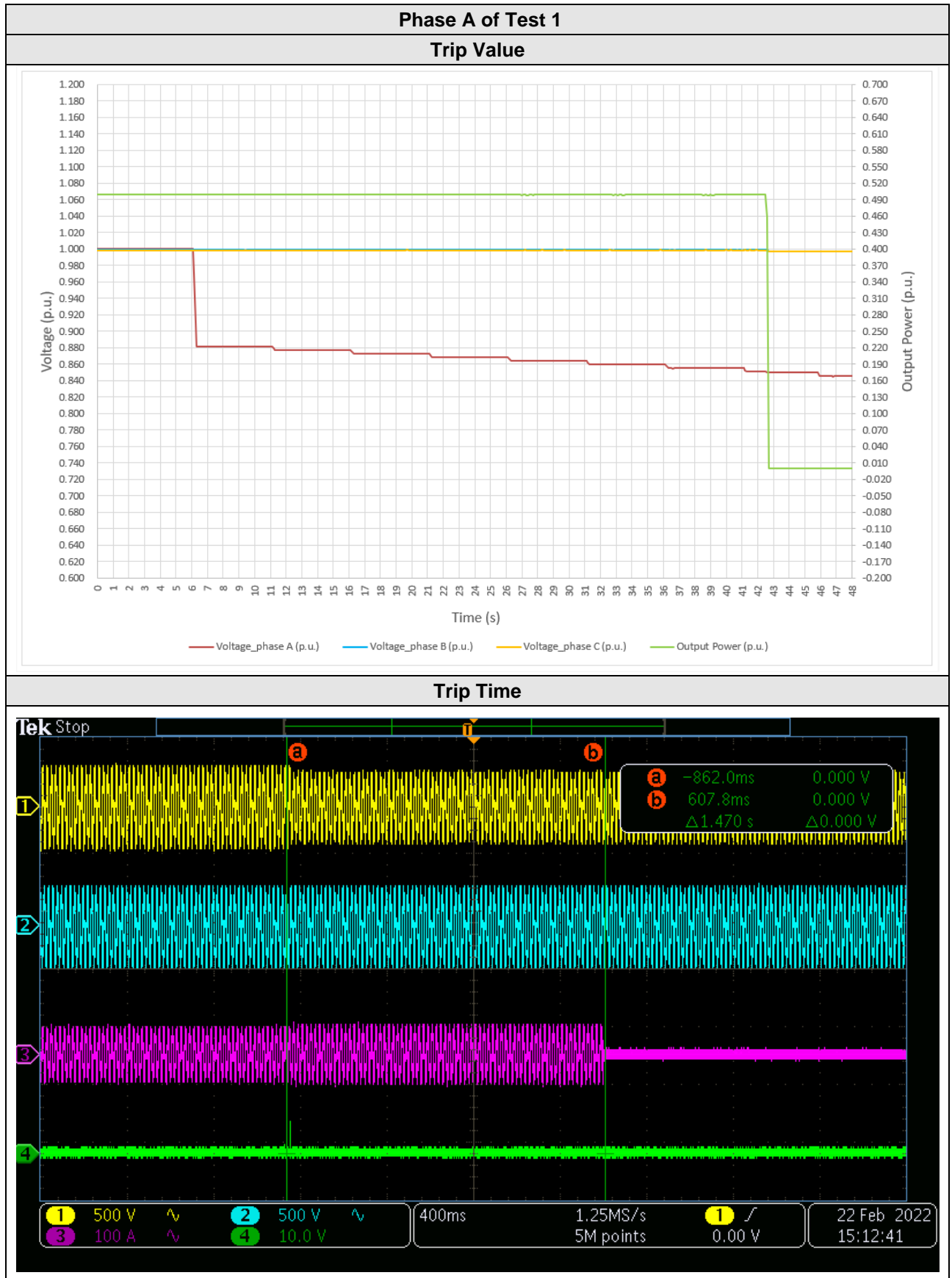

Phase A of Test 2

Trip Value



Trip Time

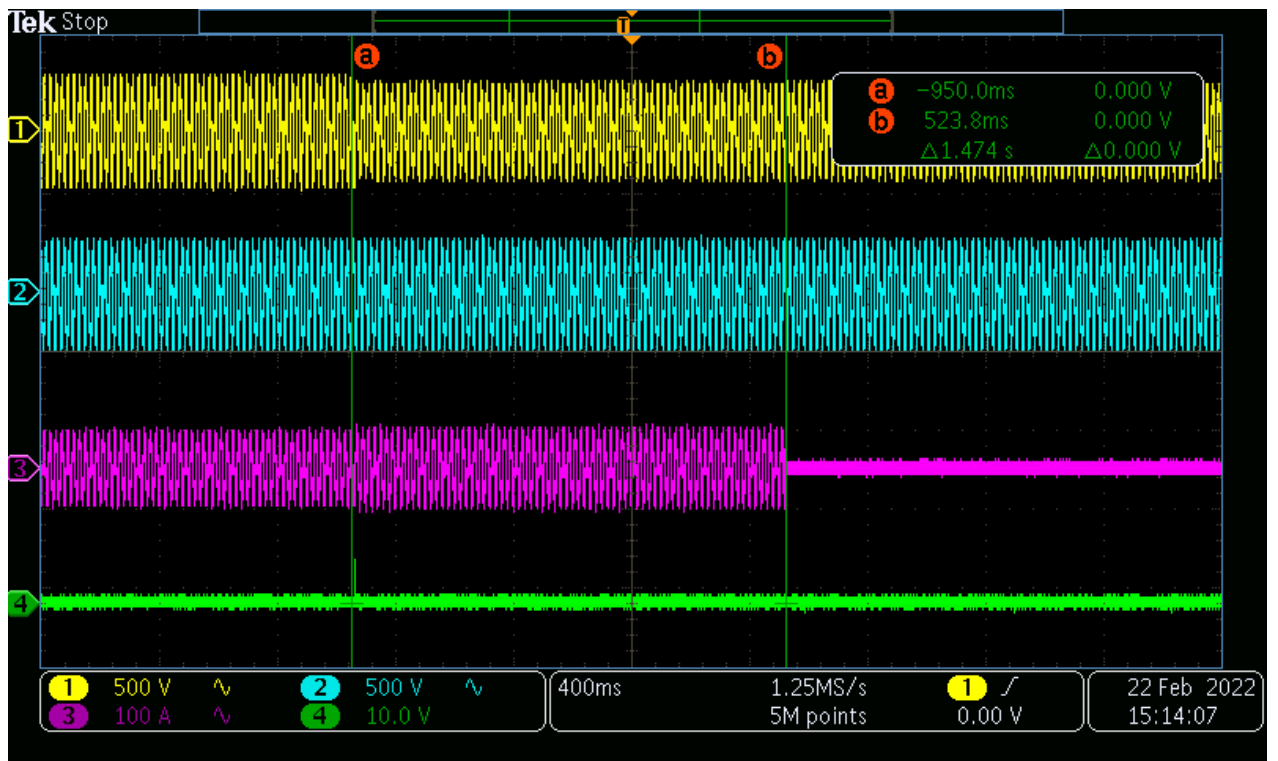

Phase A of Test 3

Trip Value



Trip Time

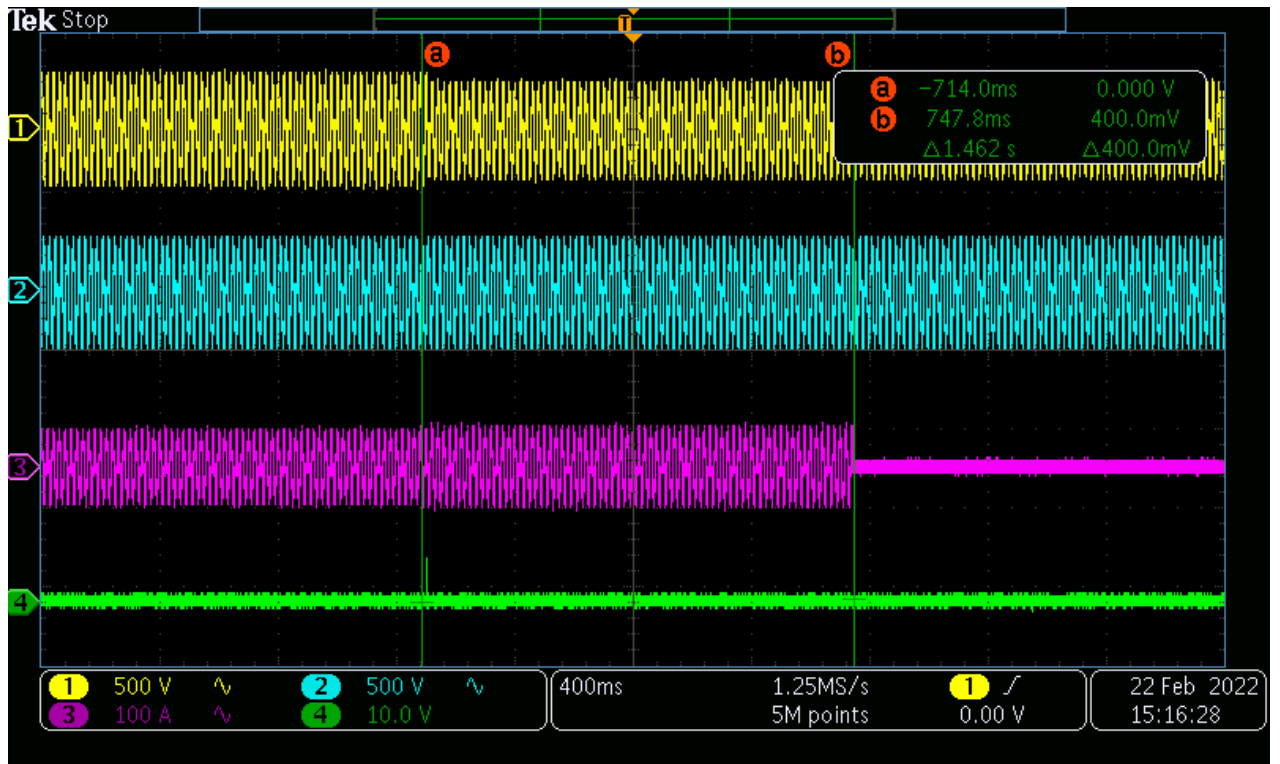



Phase B of Test 1

Trip Value

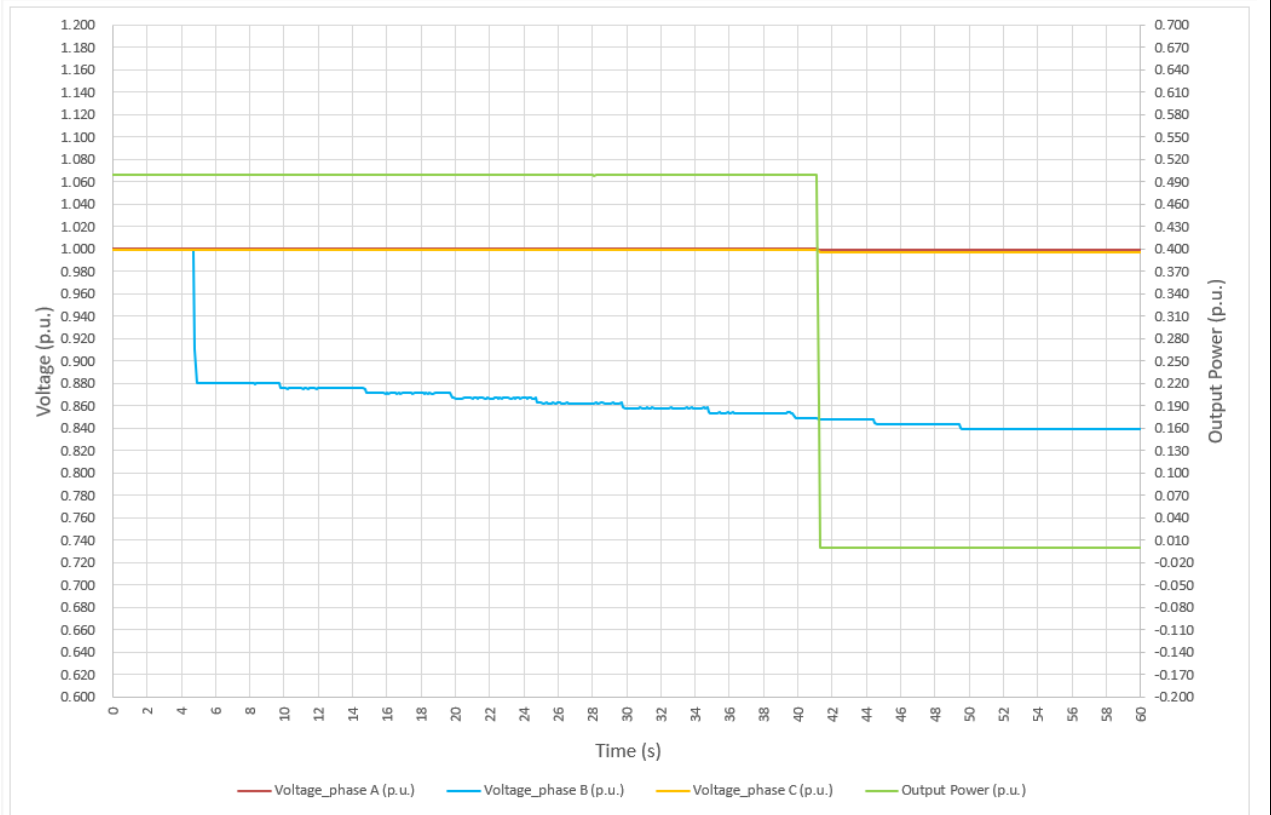

Trip Time

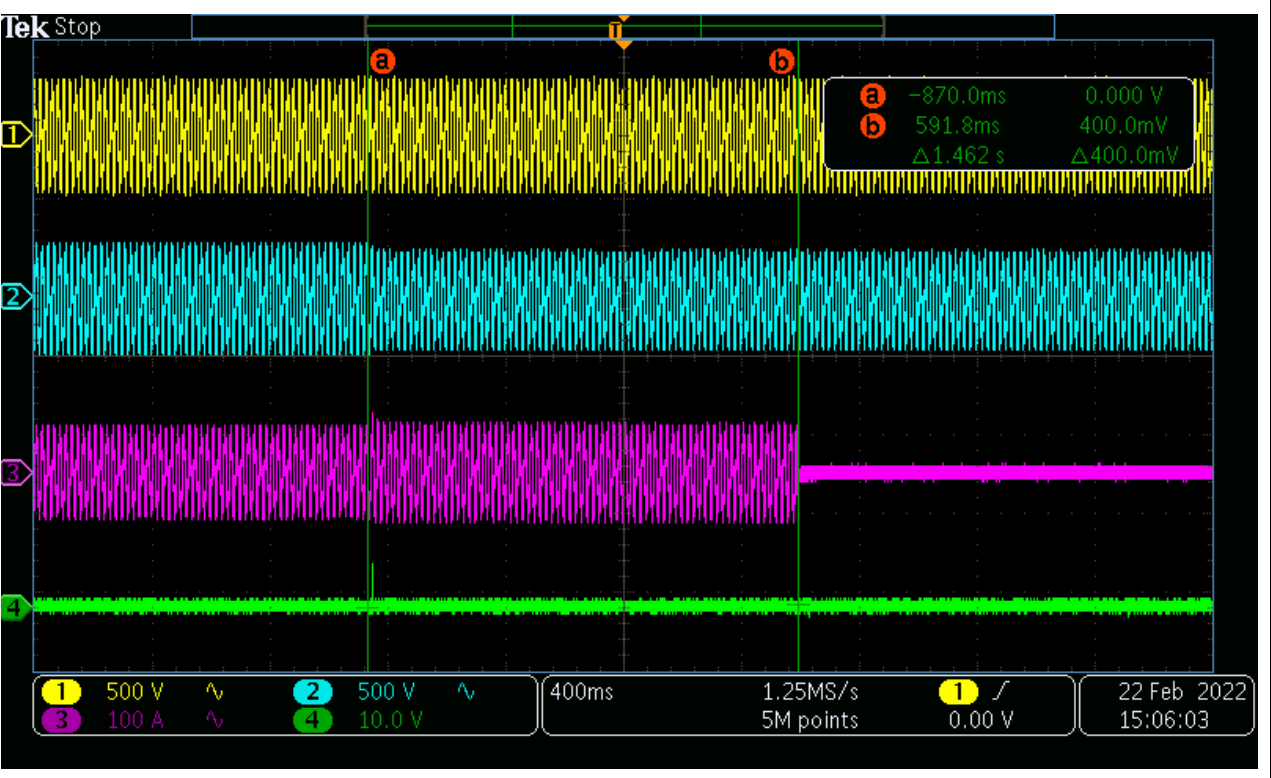

Phase B of Test 2

Trip Value

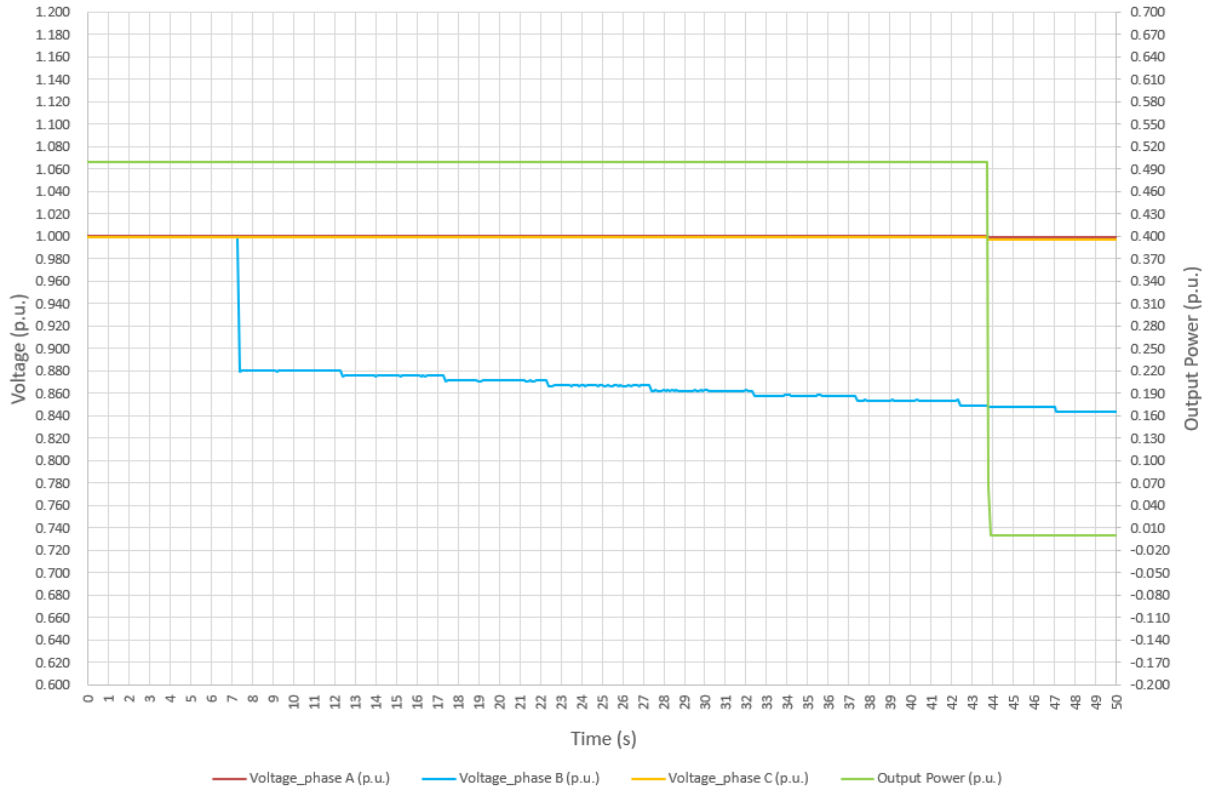

Trip Time

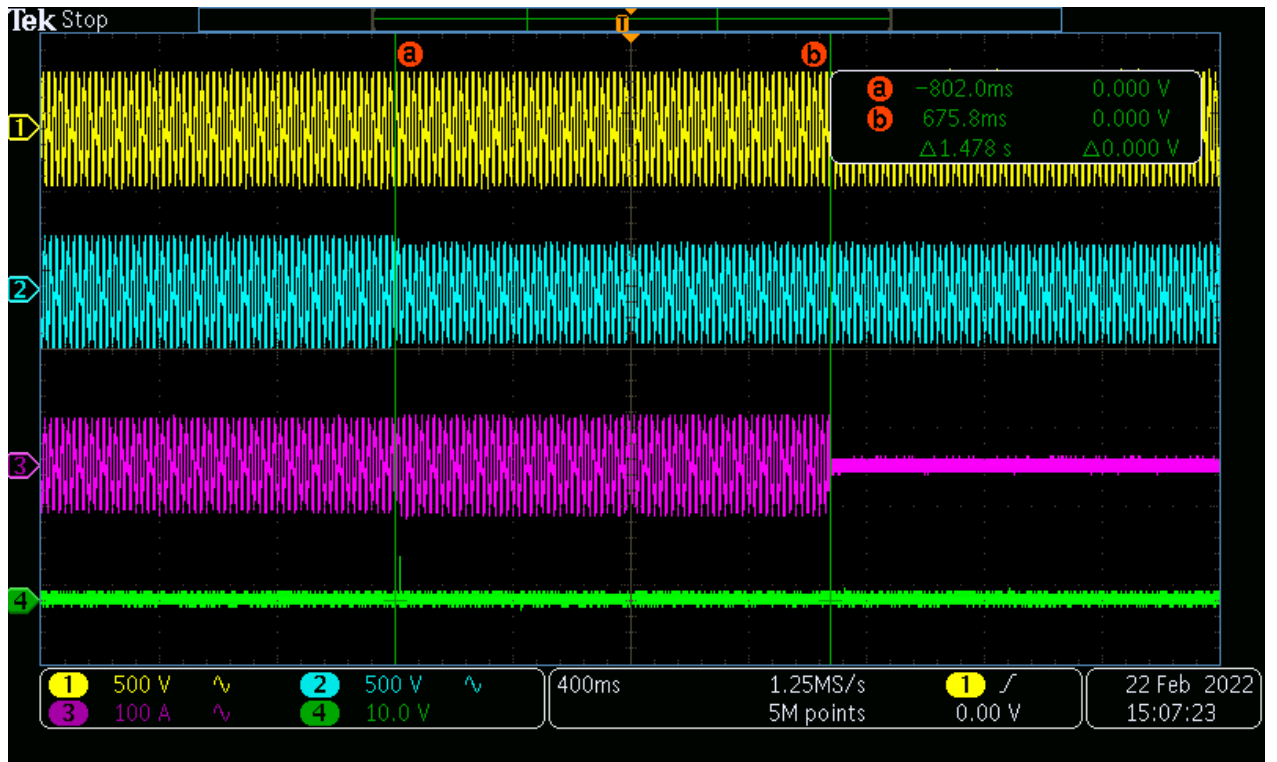

Phase B of Test 3

Trip Value

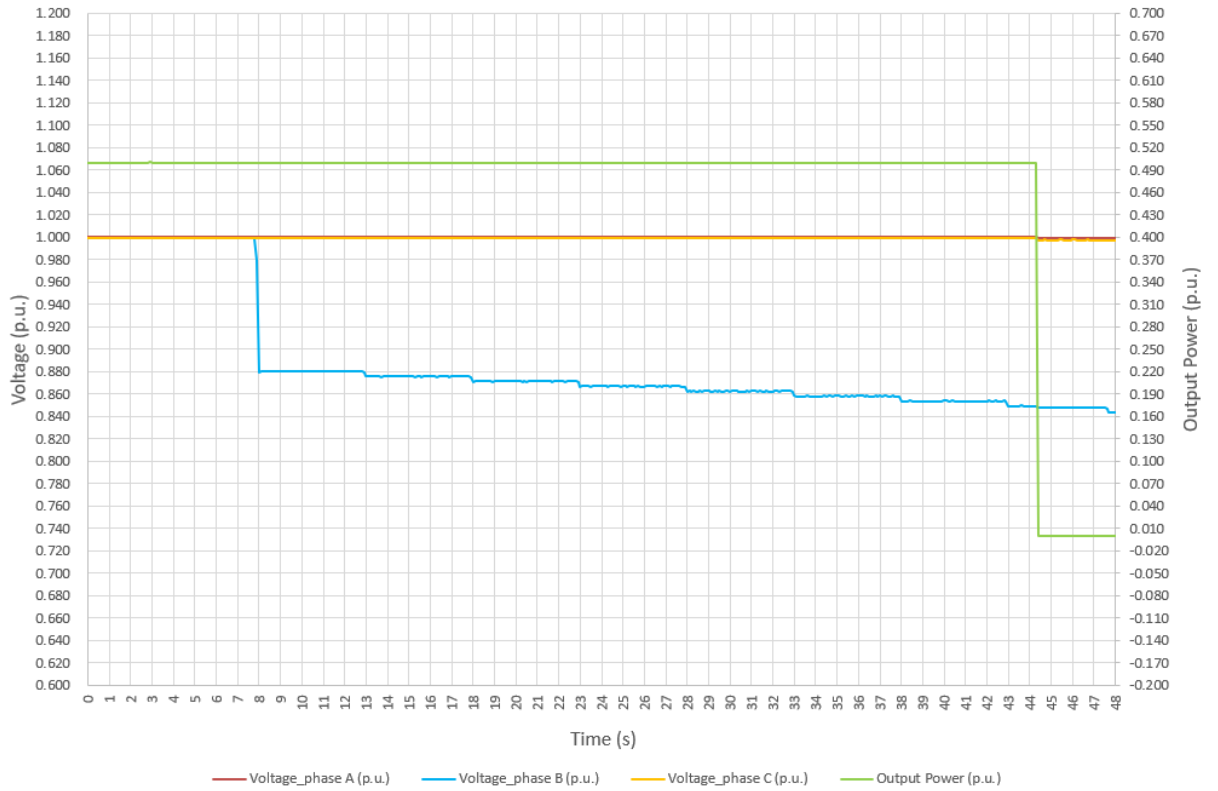

Trip Time

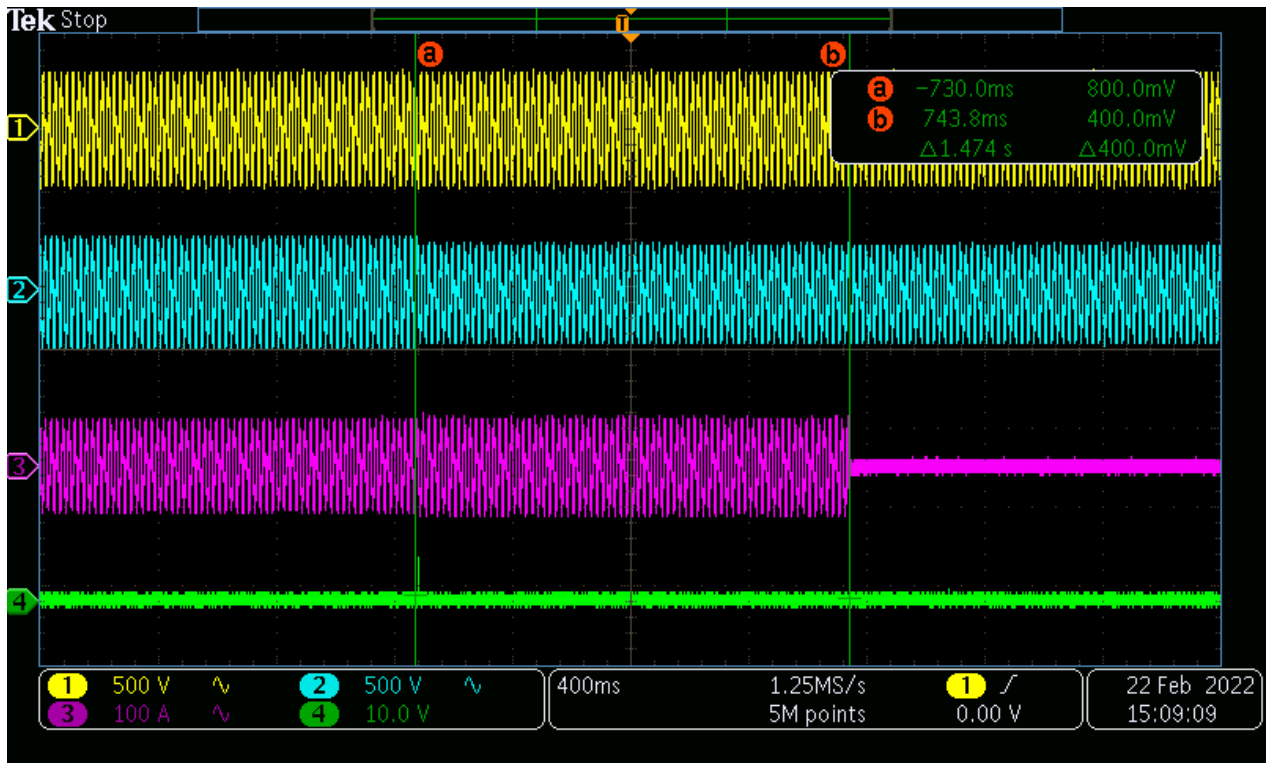

Phase C of Test 1

Trip Value



Trip Time

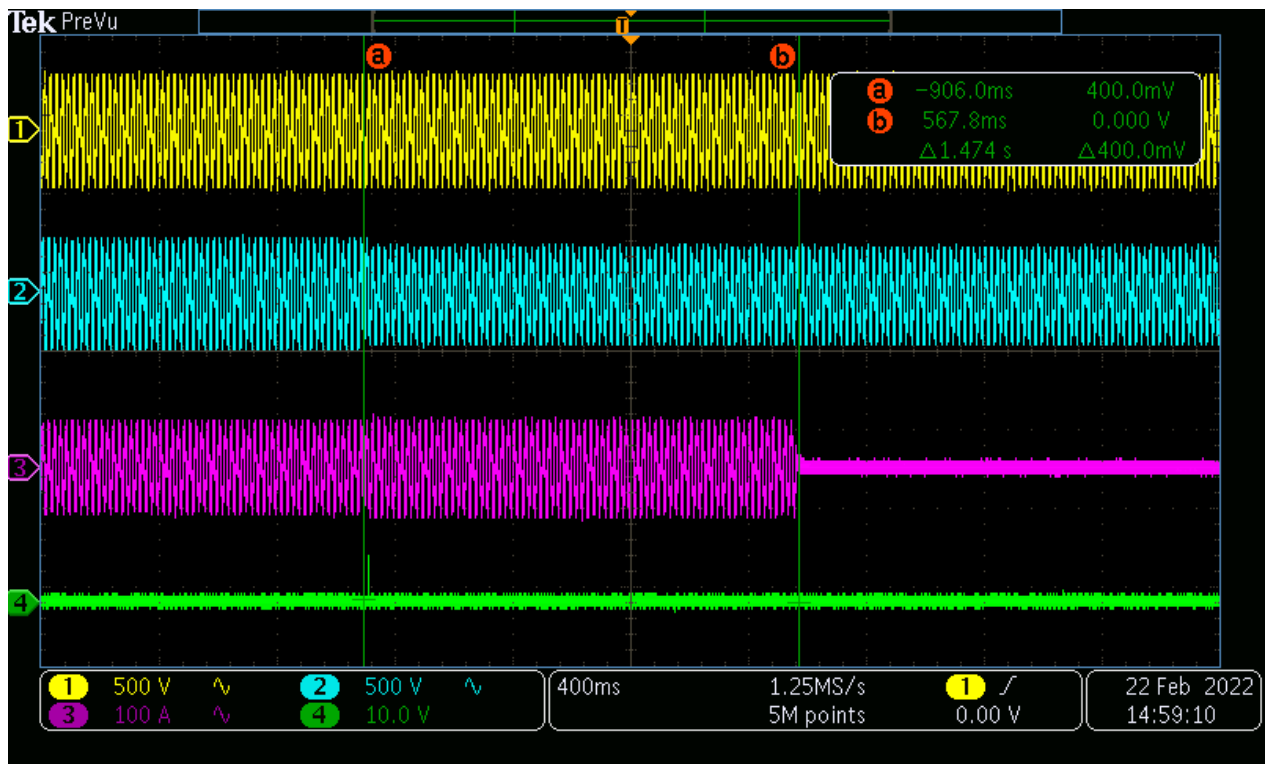

Phase C of Test 2

Trip Value

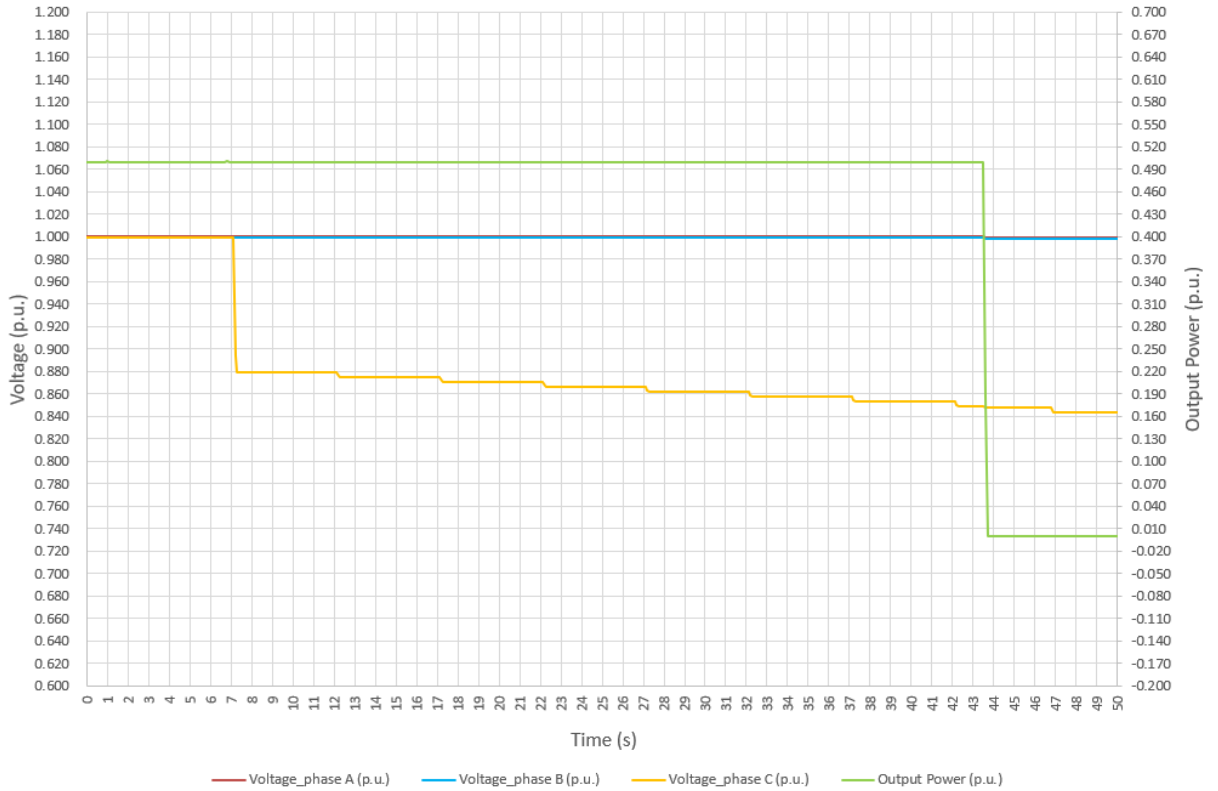

Trip Time

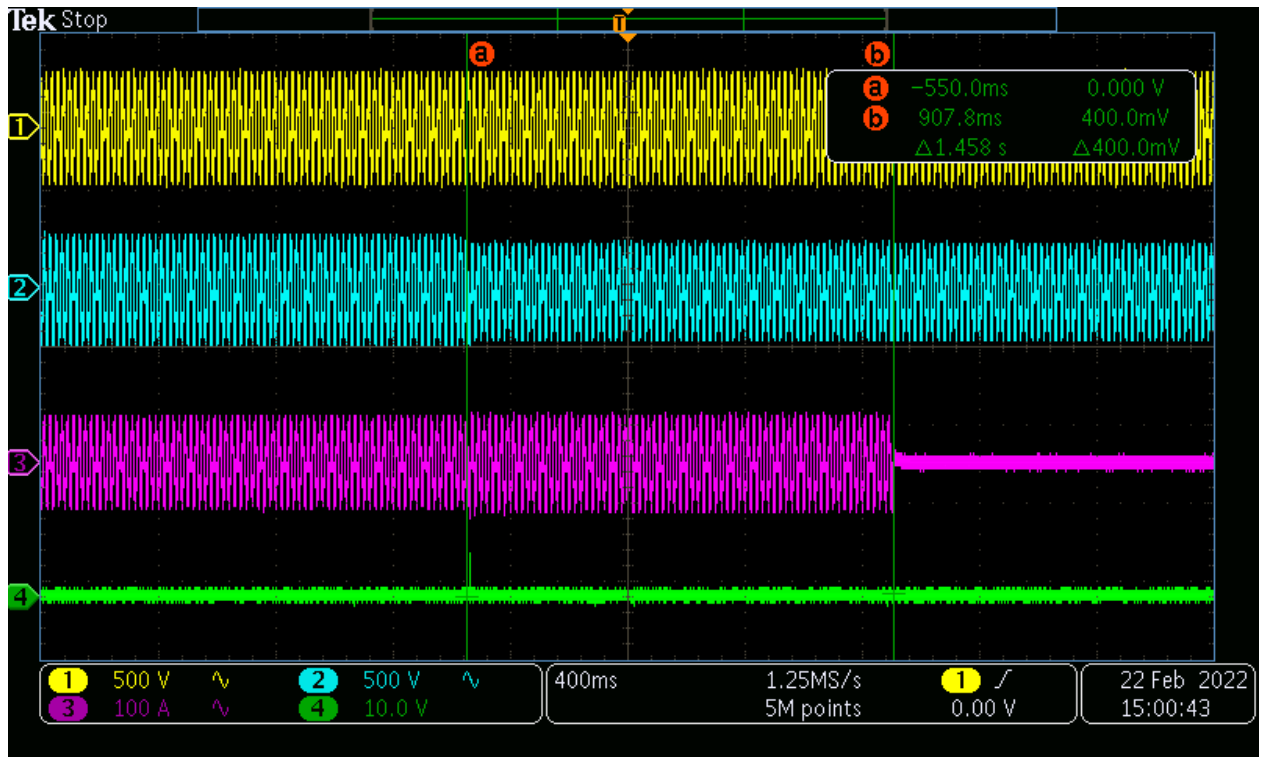

Phase C of Test 3

Trip Value

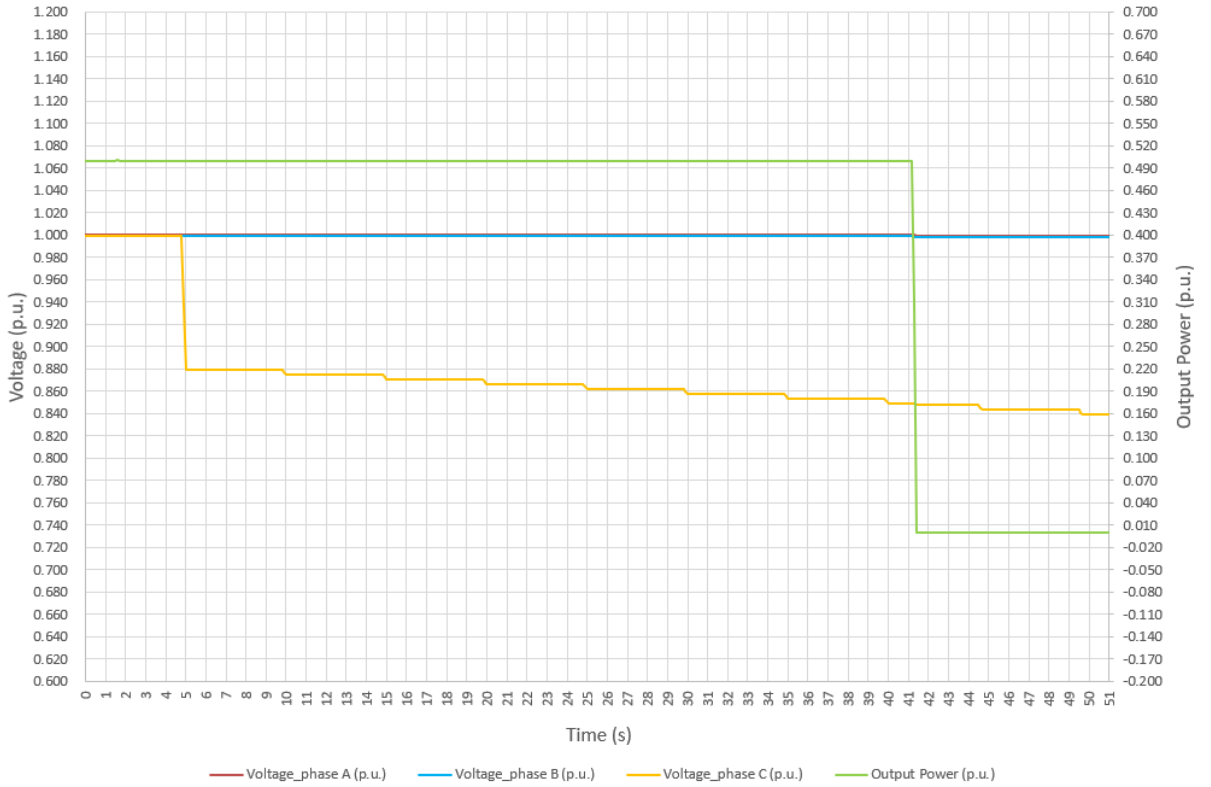

Trip Time

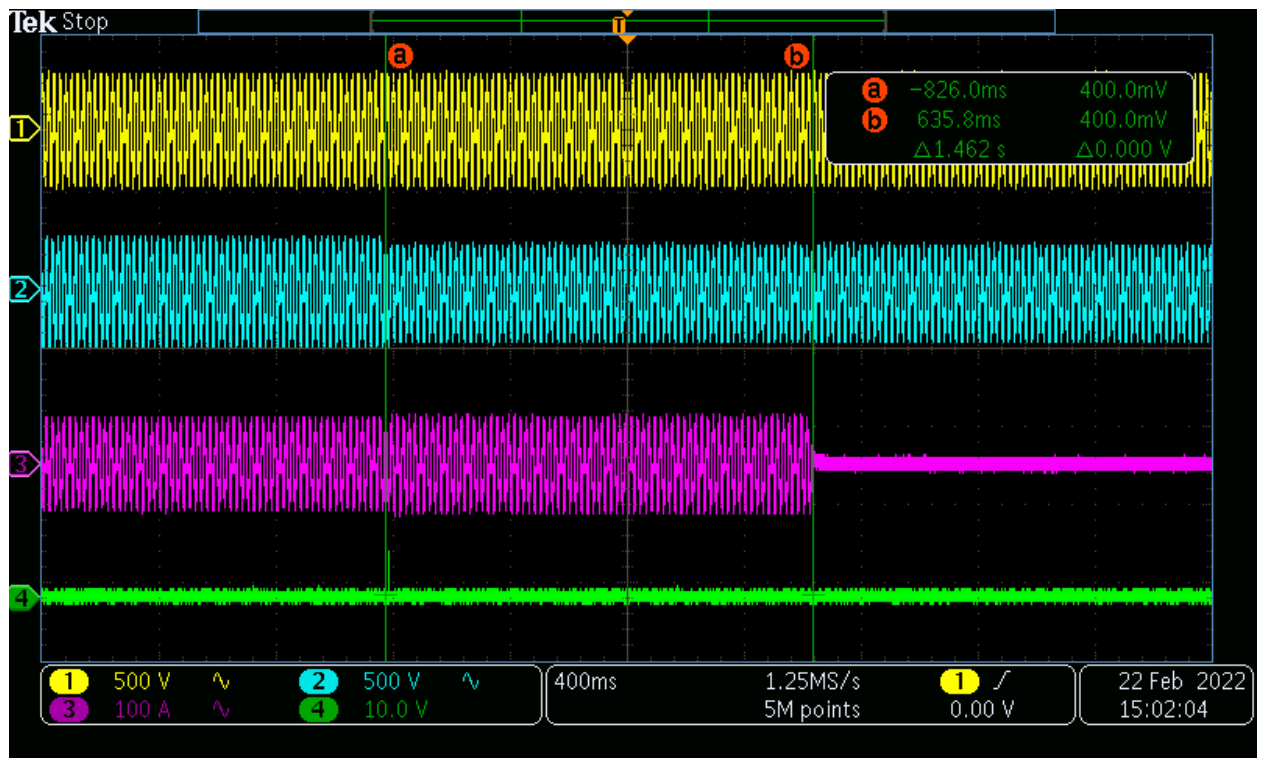

Phase ABC of Test 1

Trip Value

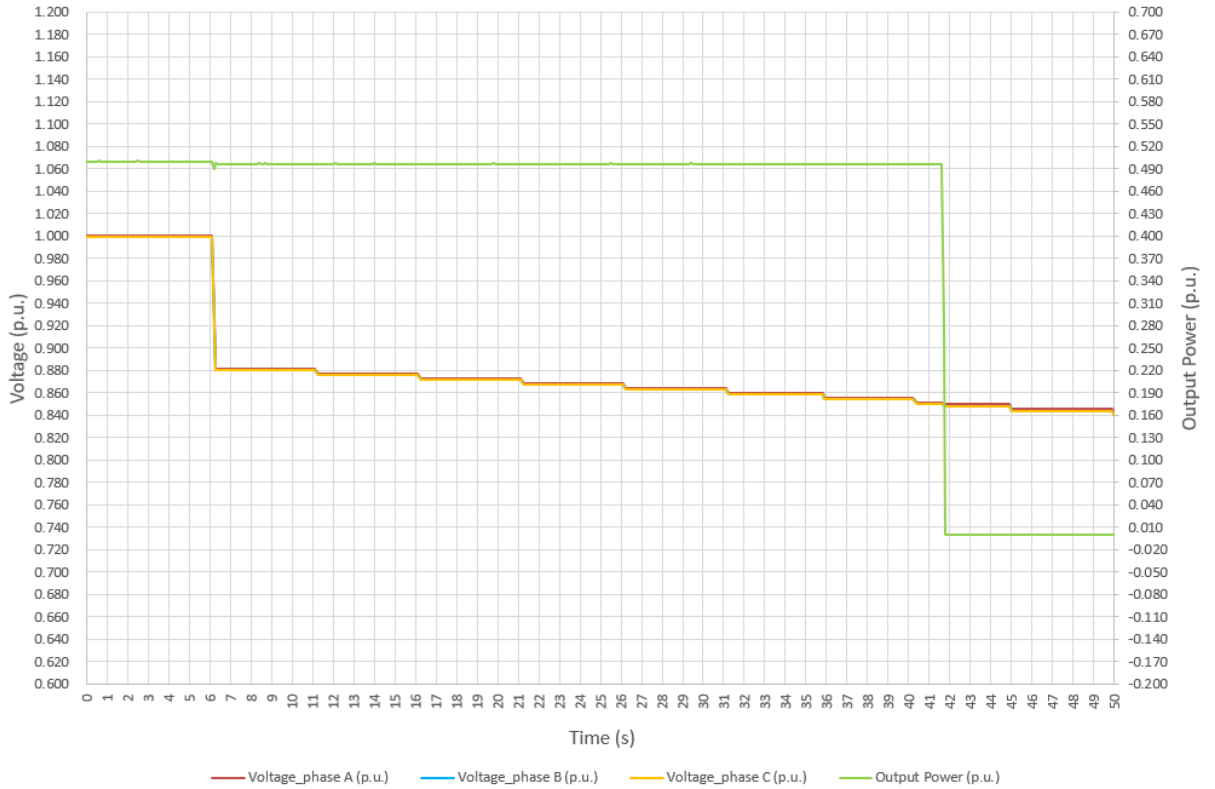

Trip Time

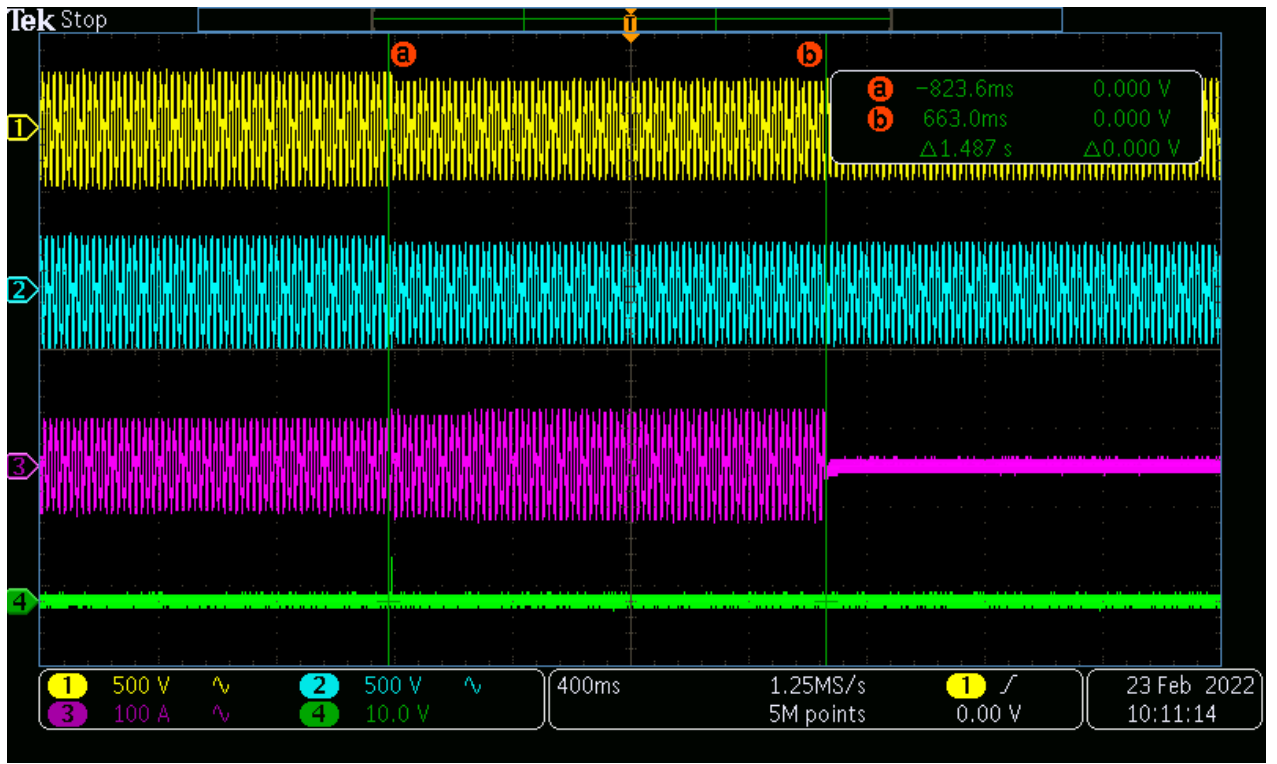

Phase ABC of Test 2

Trip Value

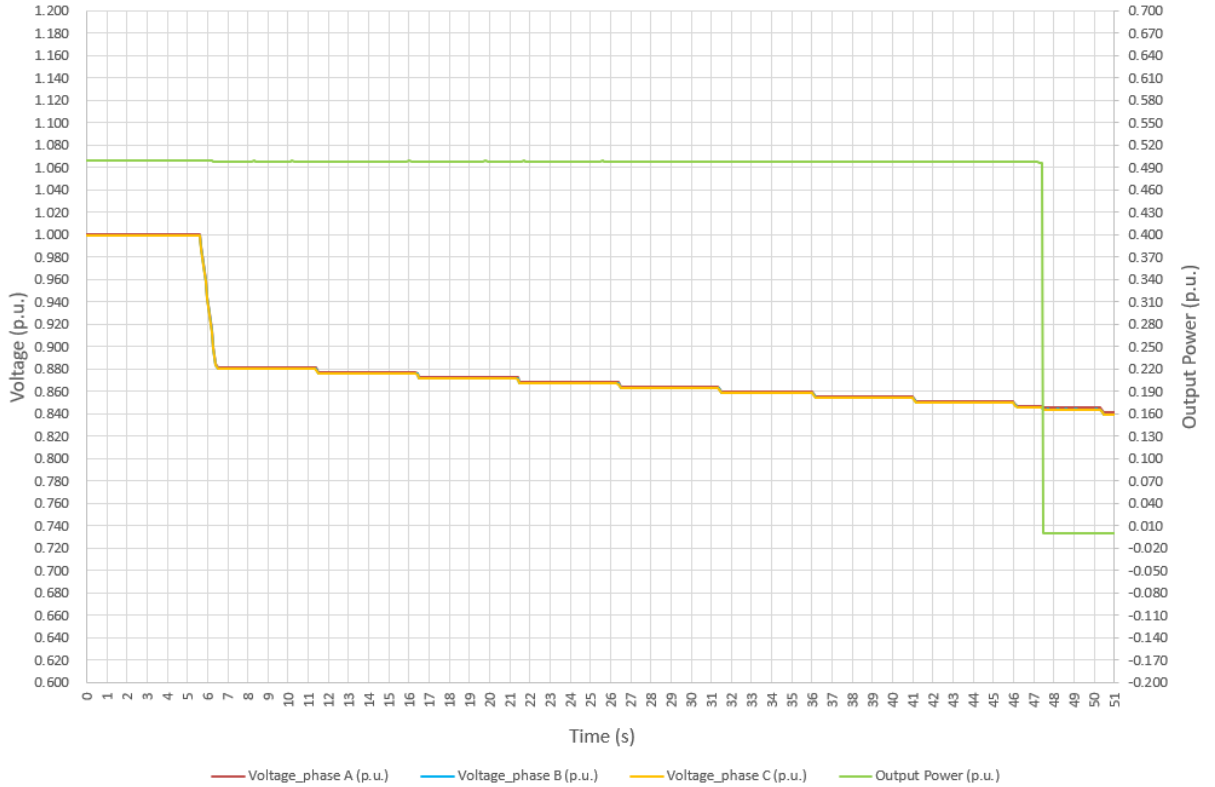

Trip Time

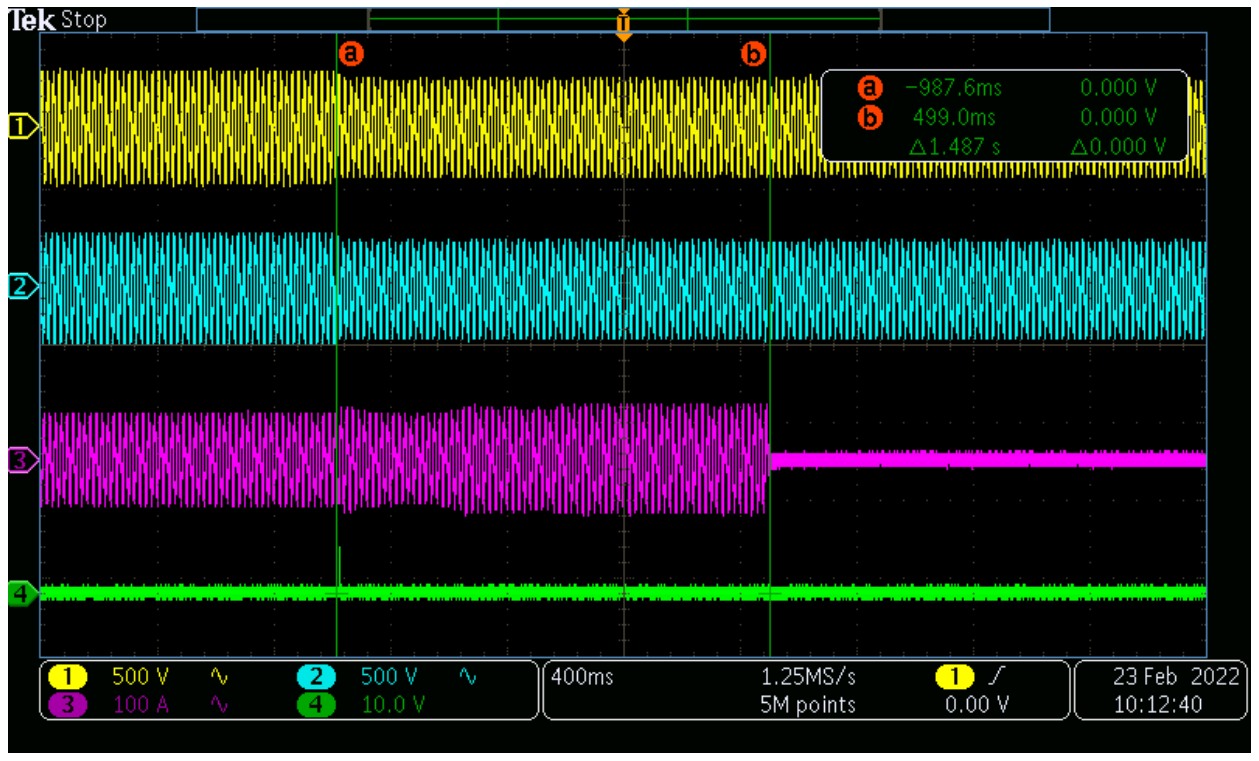



Phase ABC of Test 3

Trip Value

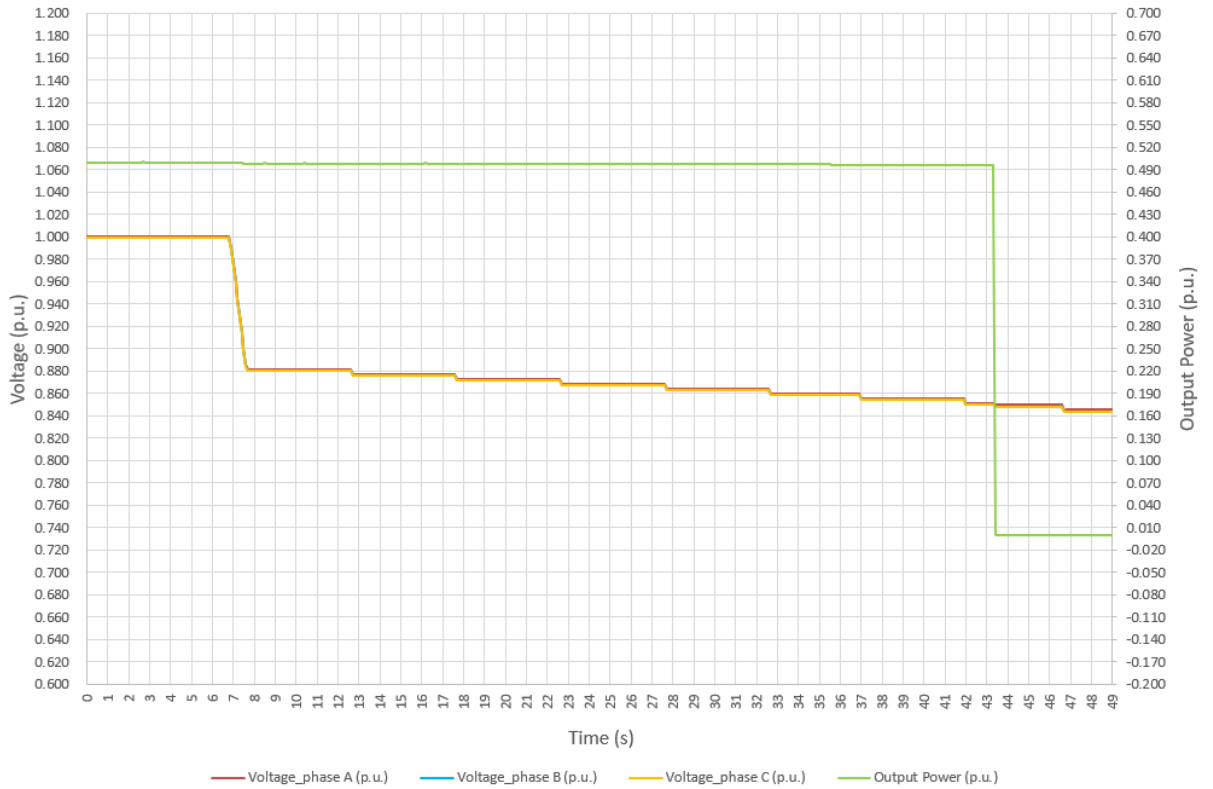

Trip Time

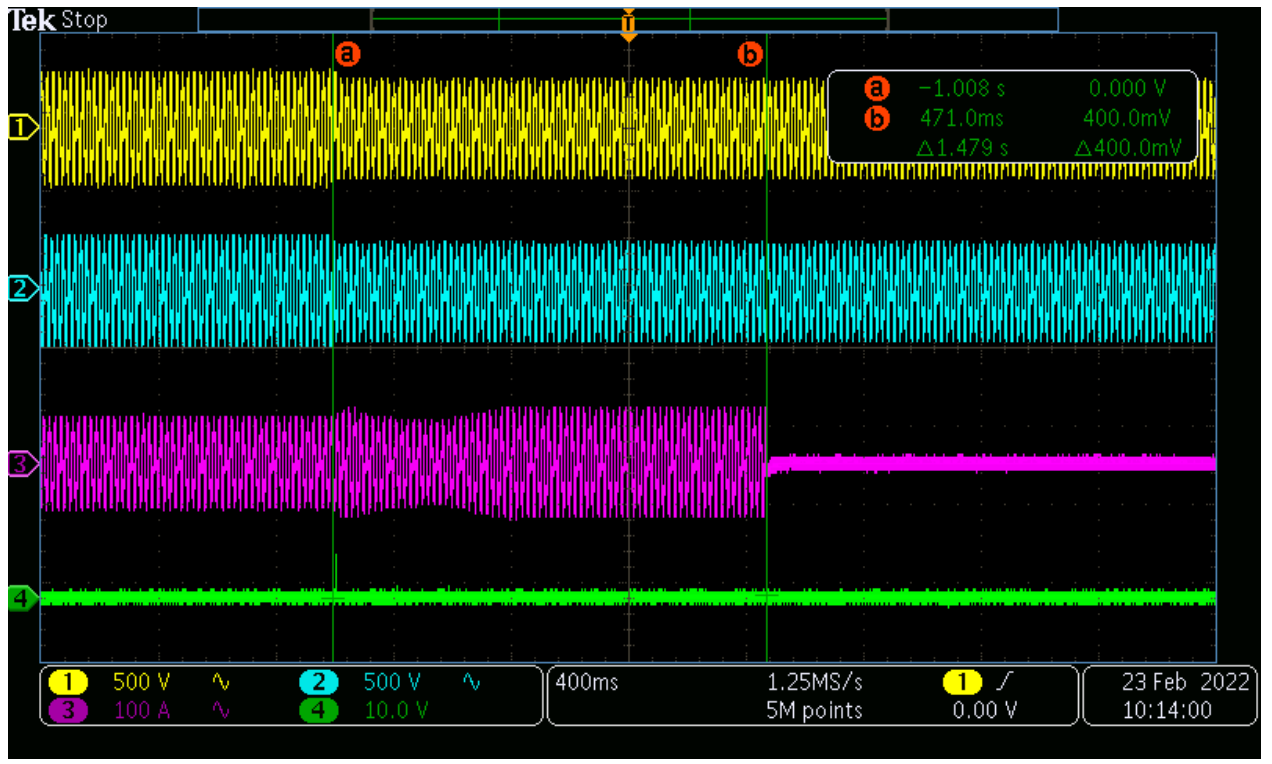

**4.6.4.2 Overvoltage protection (Country / Region: Poland)**

Overvoltage of 115%Un				
Phase A				
Parameter	Settings	Test 1	Test 2	Test 3
Trip value [V]	264.5	264.7	264.7	264.7
Trip time [s]	< 0.200	0.168	0.174	0.170
Phase B				
Parameter	Settings	Test 1	Test 2	Test 3
Trip value [V]	264.5	264.5	264.5	264.5
Trip time [s]	< 0.200	0.170	0.174	0.173
Phase C				
Parameter	Settings	Test 1	Test 2	Test 3
Trip value [V]	264.5	264.4	264.5	264.5
Trip time [s]	< 0.200	0.177	0.176	0.178
Phase ABC				
Parameter	Settings	Test 1	Test 2	Test 3
Trip value [V]	264.5	264.4	264.4	264.4
Trip time [s]	< 0.200	0.173	0.177	0.175

Test results are represented at diagrams below.

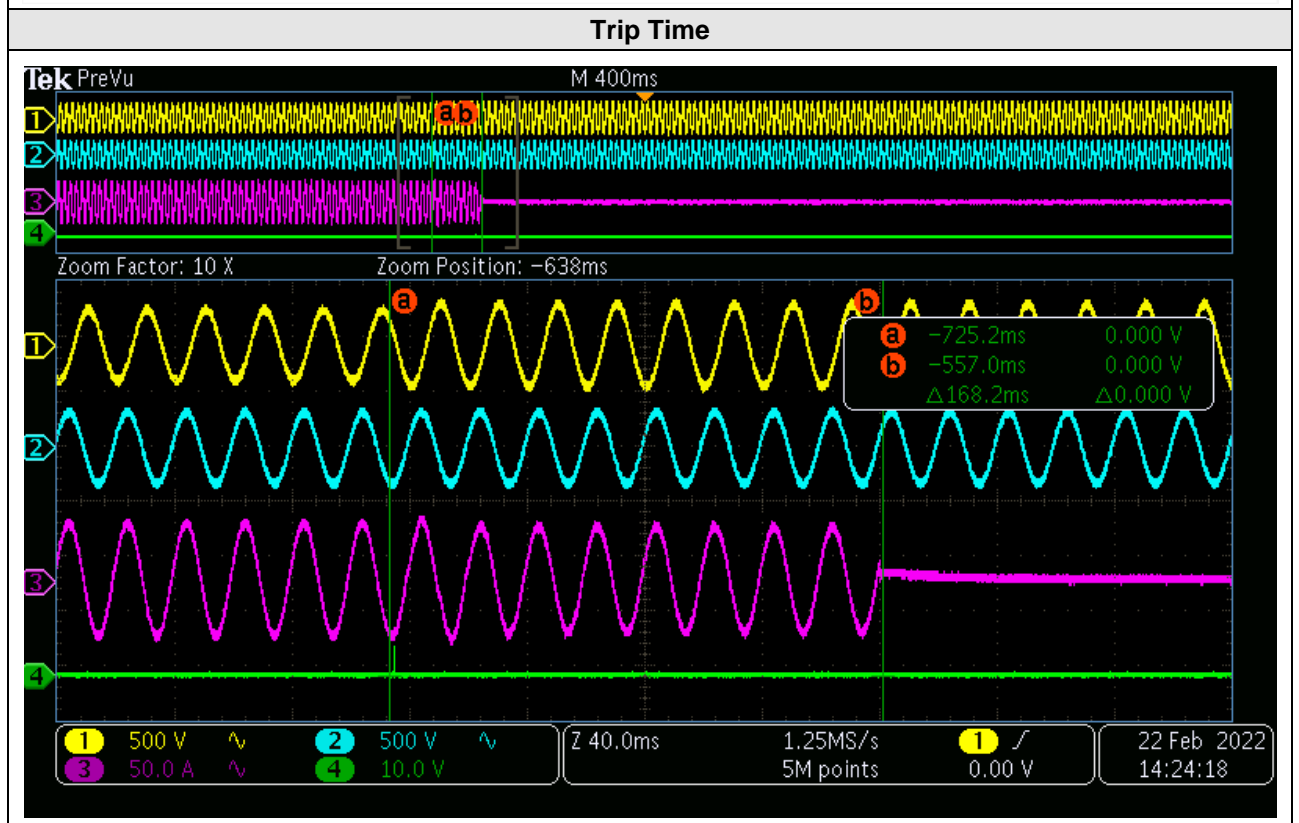
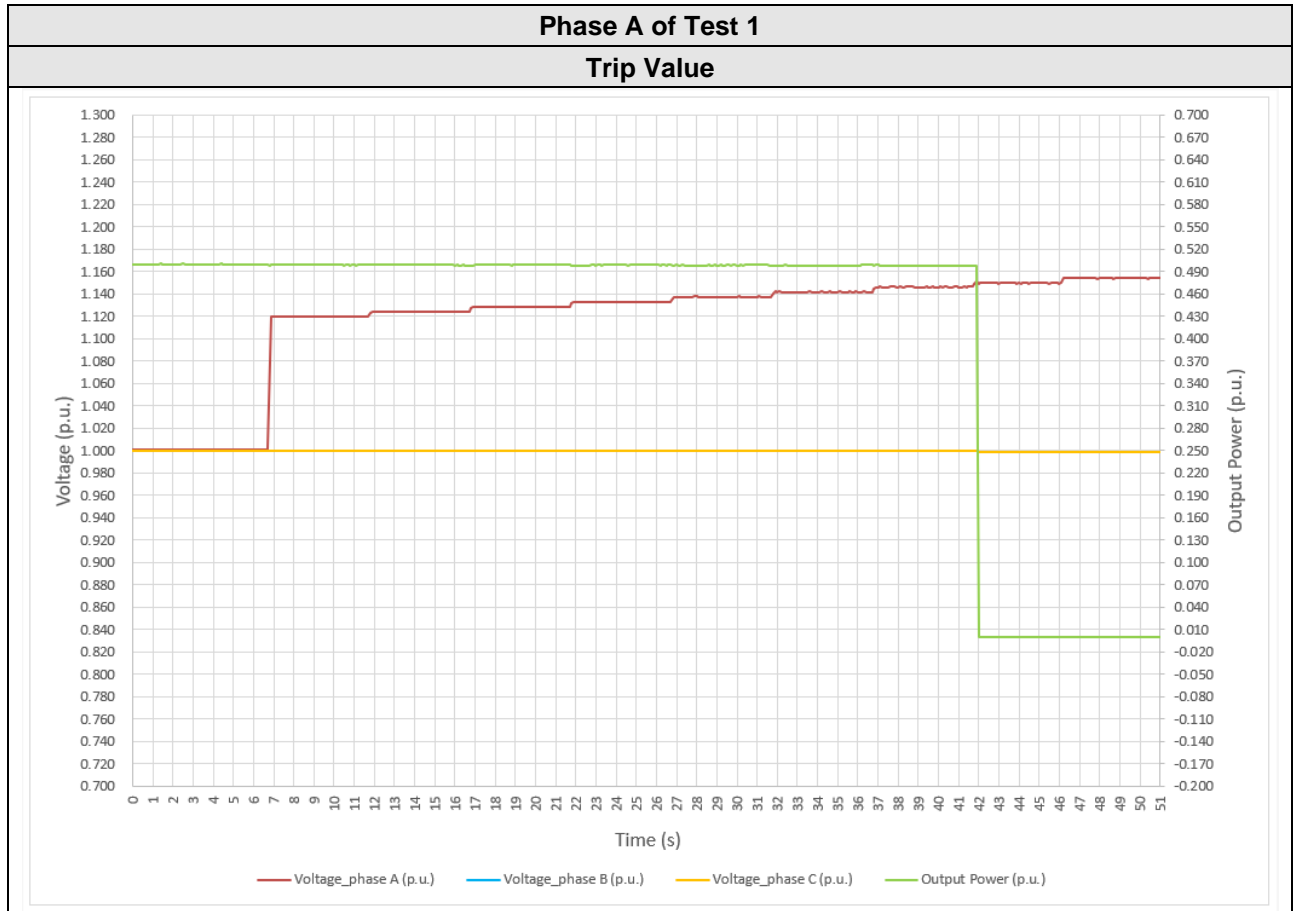

Phase A of Test 2

Trip Value

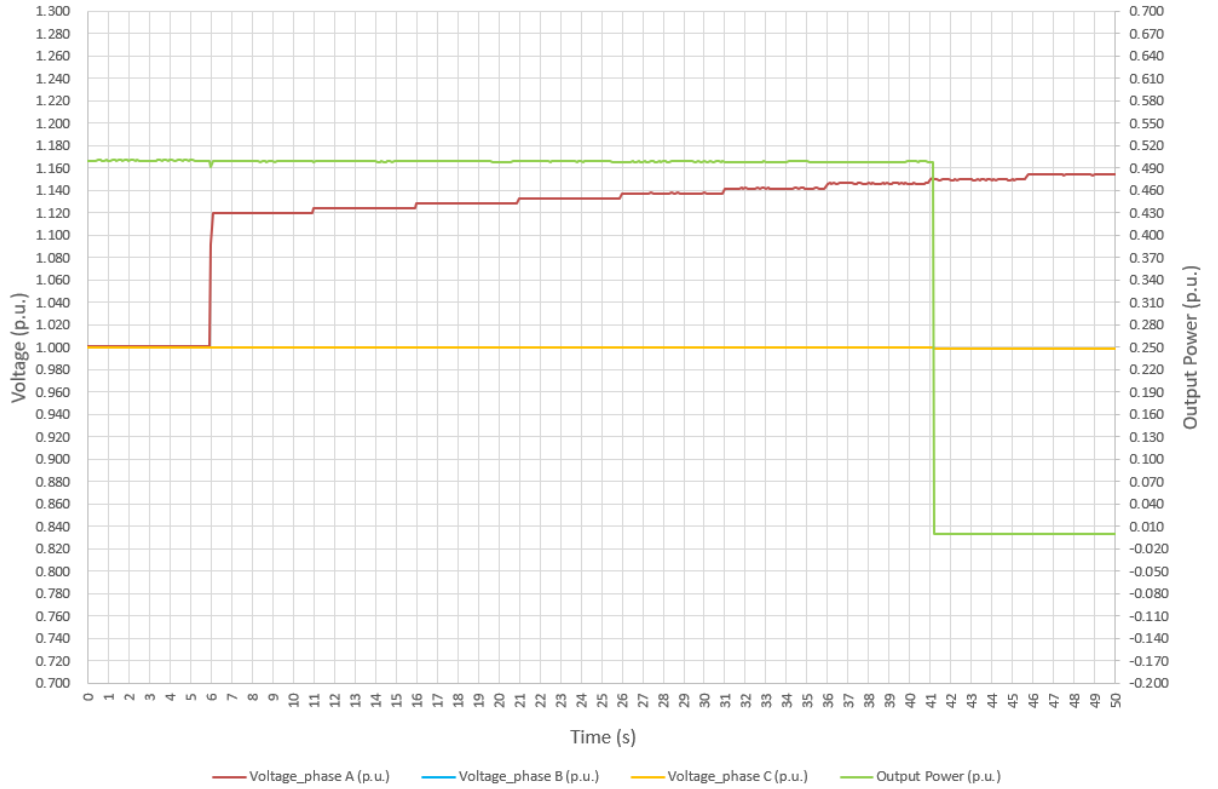

Trip Time

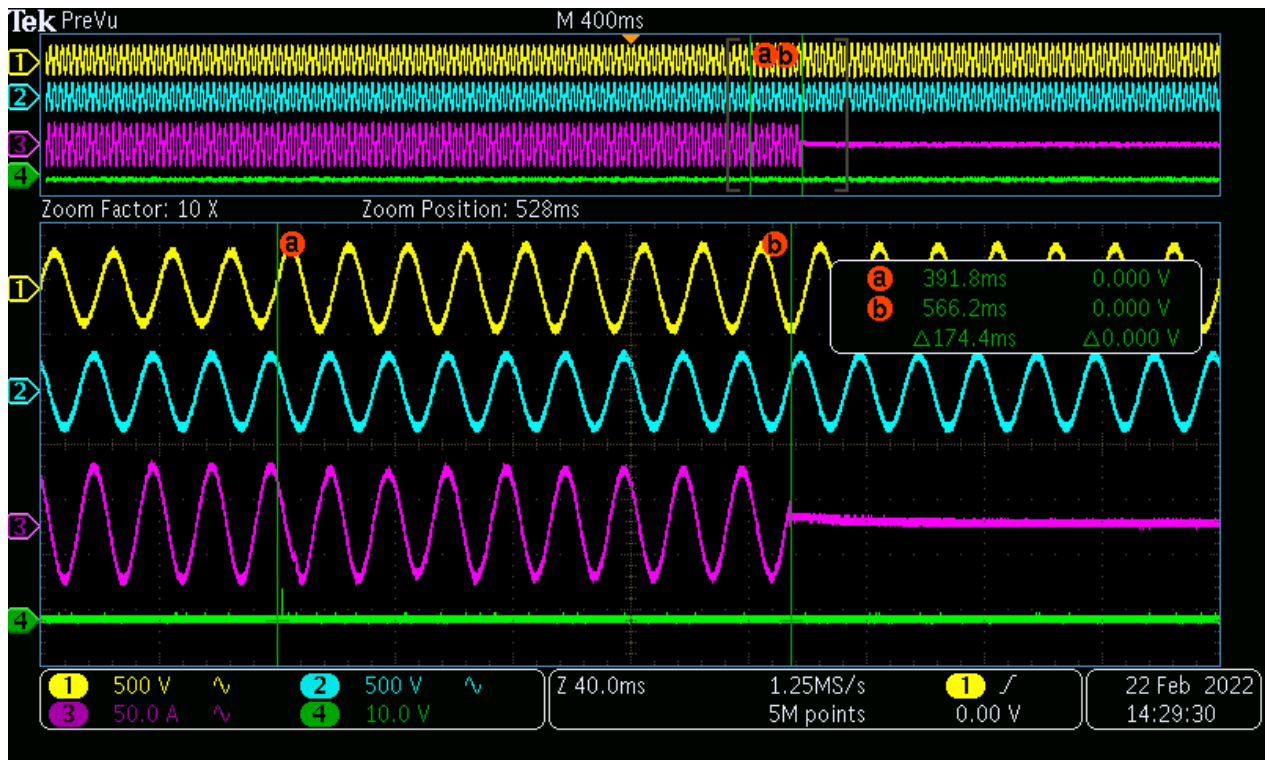

Phase A of Test 3

Trip Value

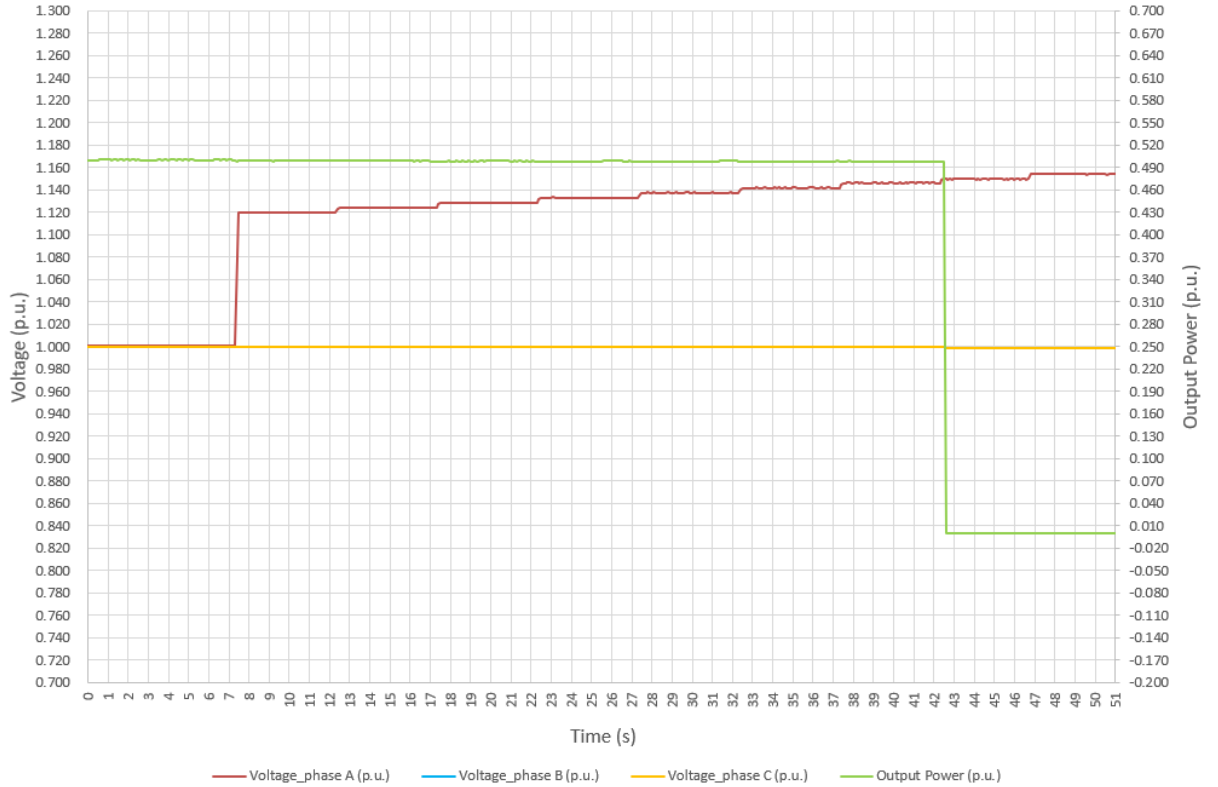

Trip Time

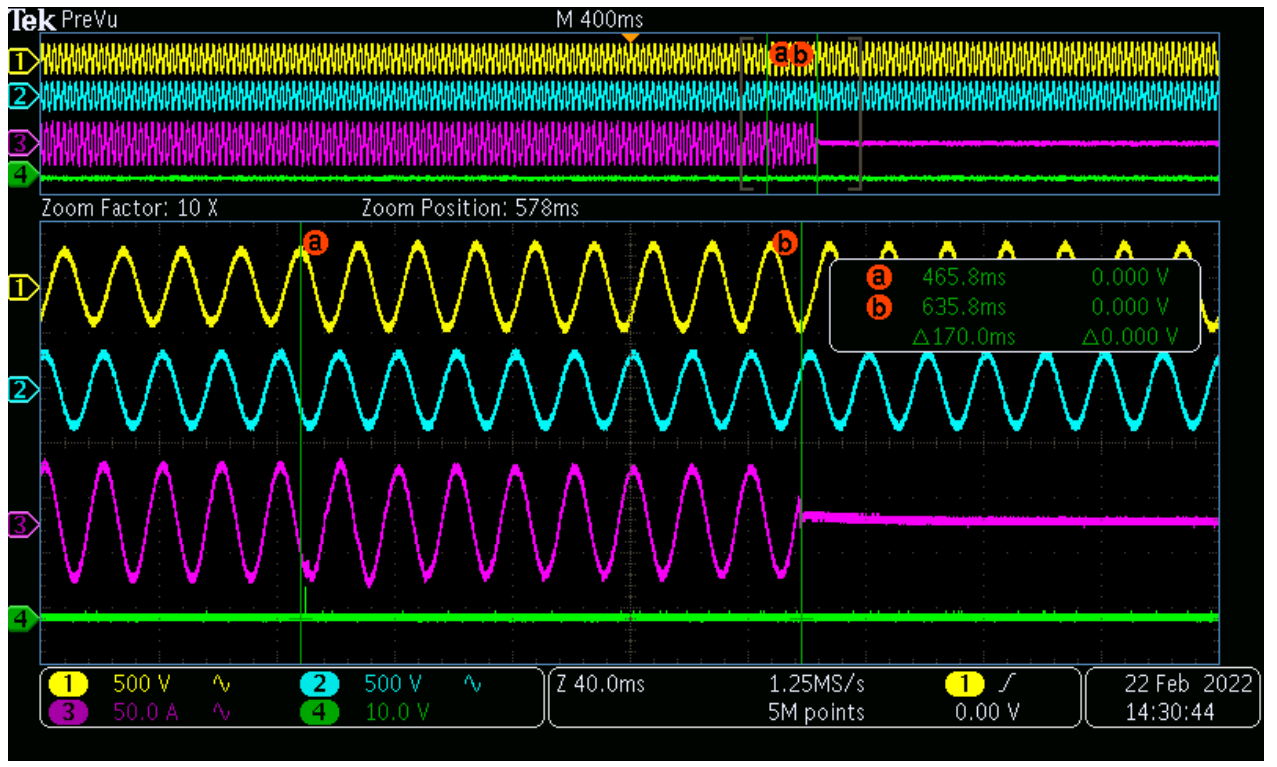

Phase B of Test 1

Trip Value

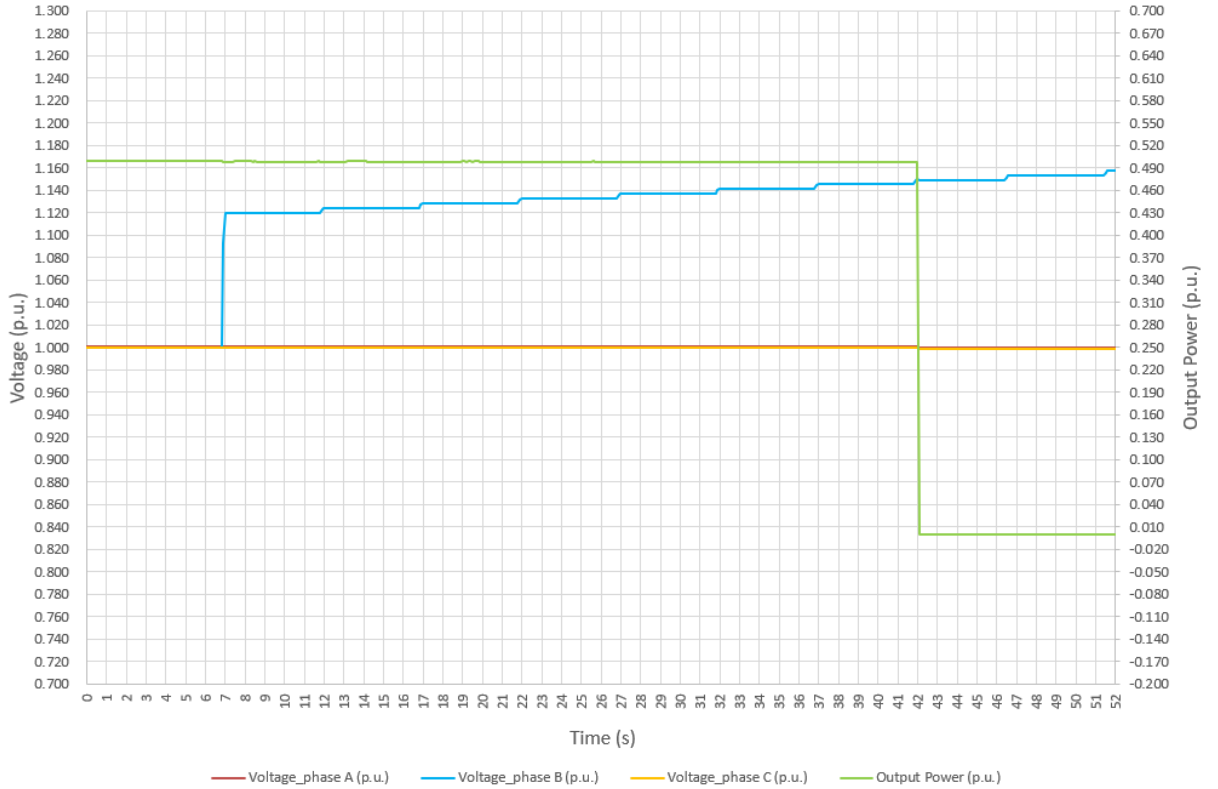

Trip Time

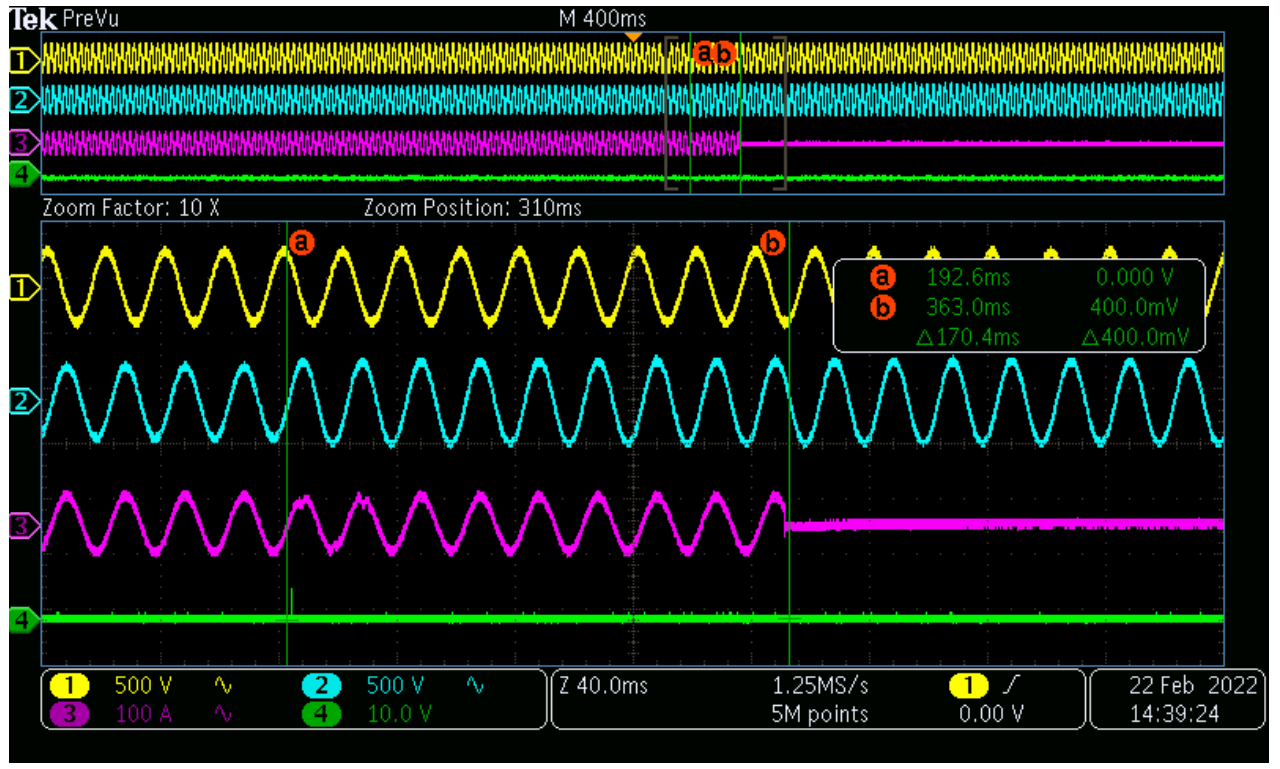

Phase B of Test 2

Trip Value

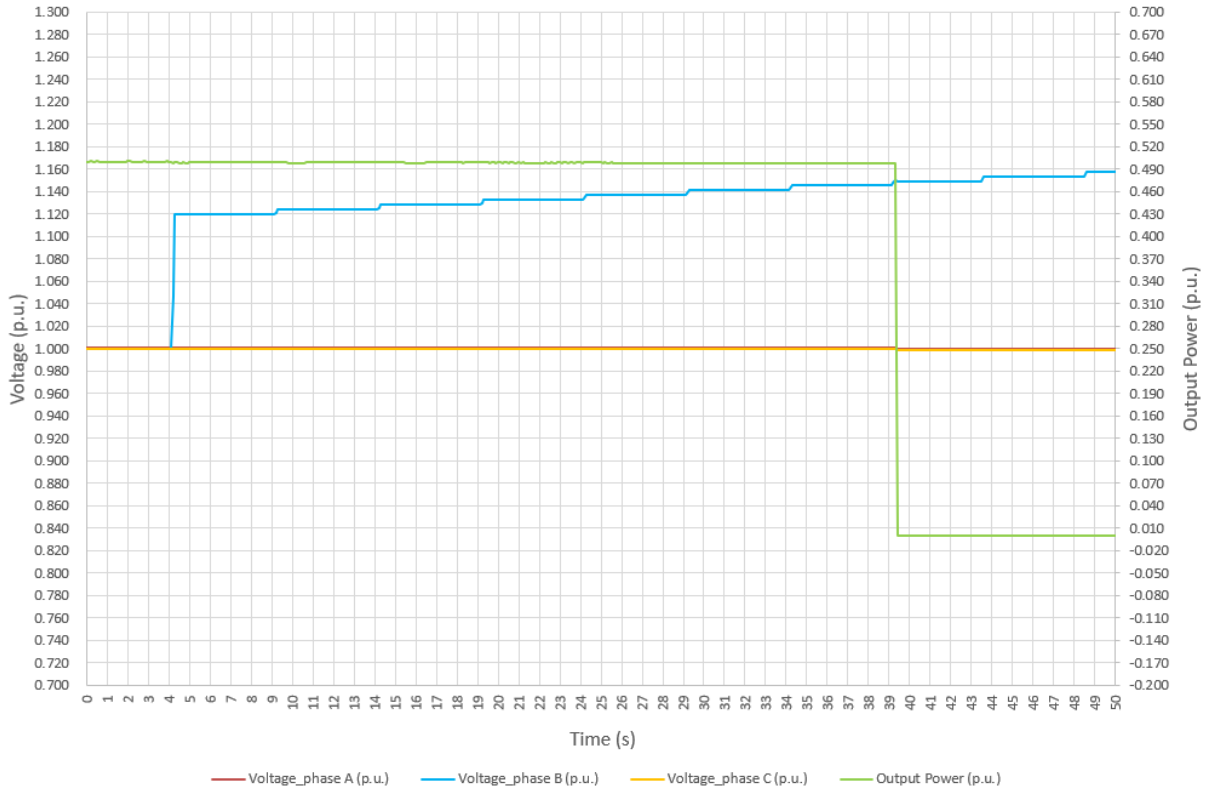

Trip Time

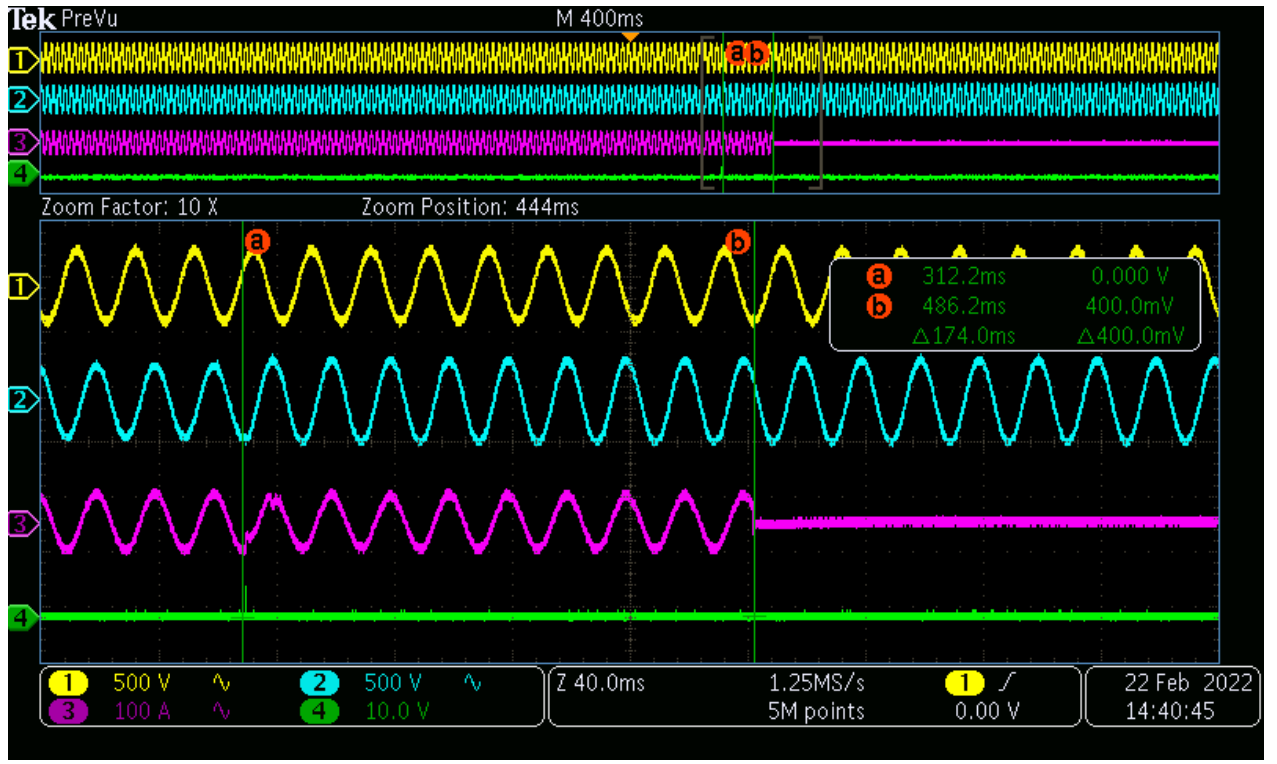

Phase B of Test 3

Trip Value

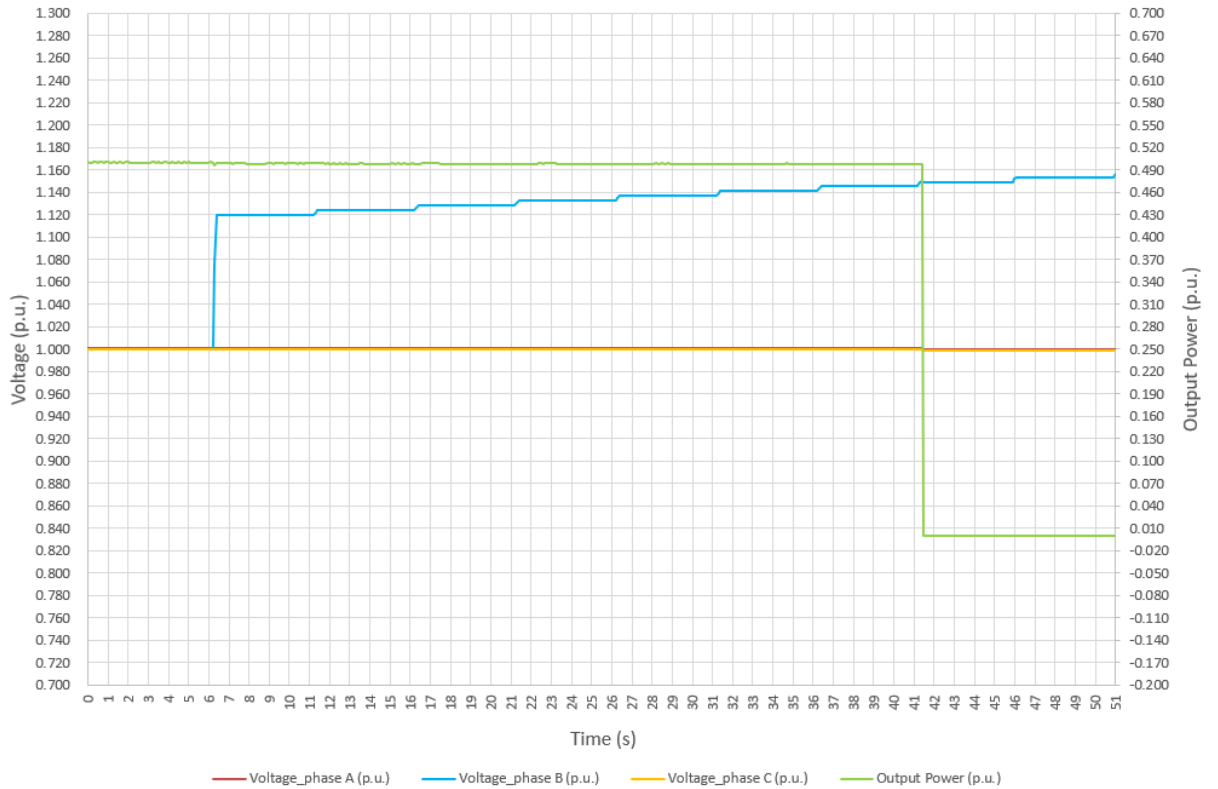

Trip Time

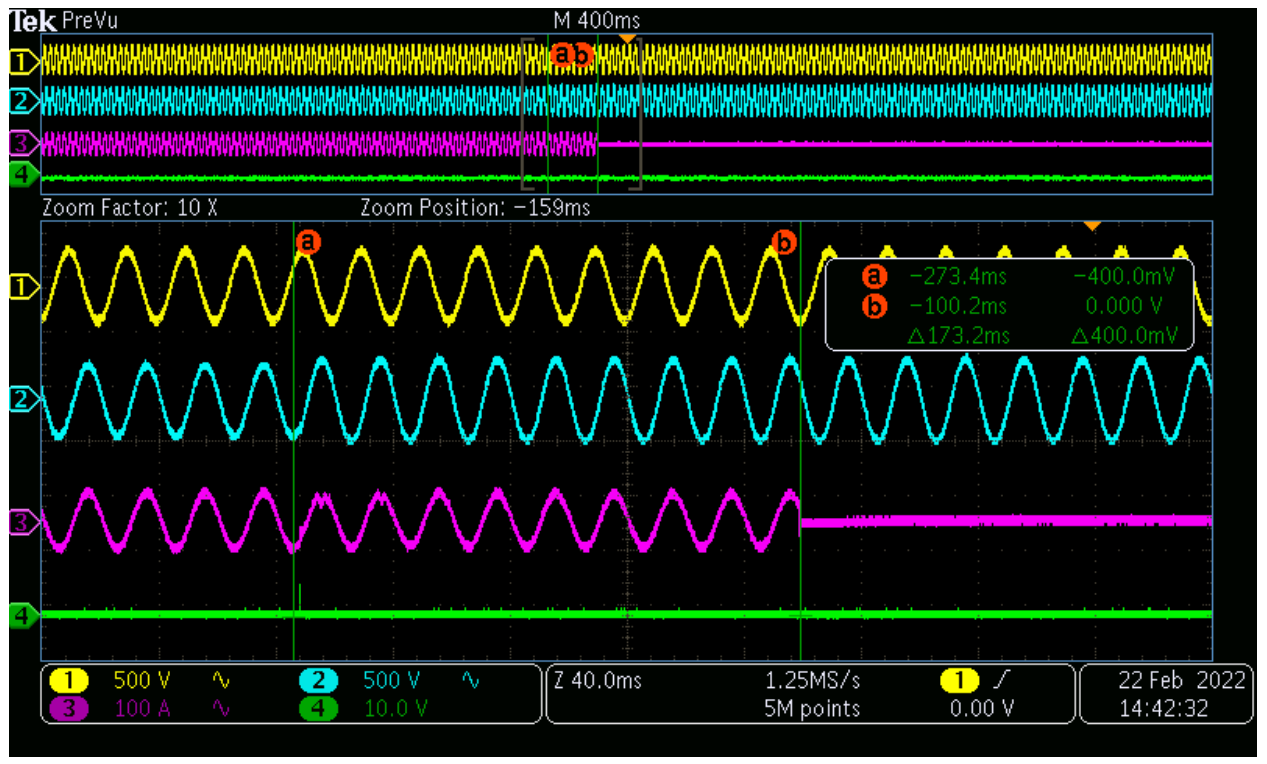



Phase C of Test 1

Trip Value



Trip Time

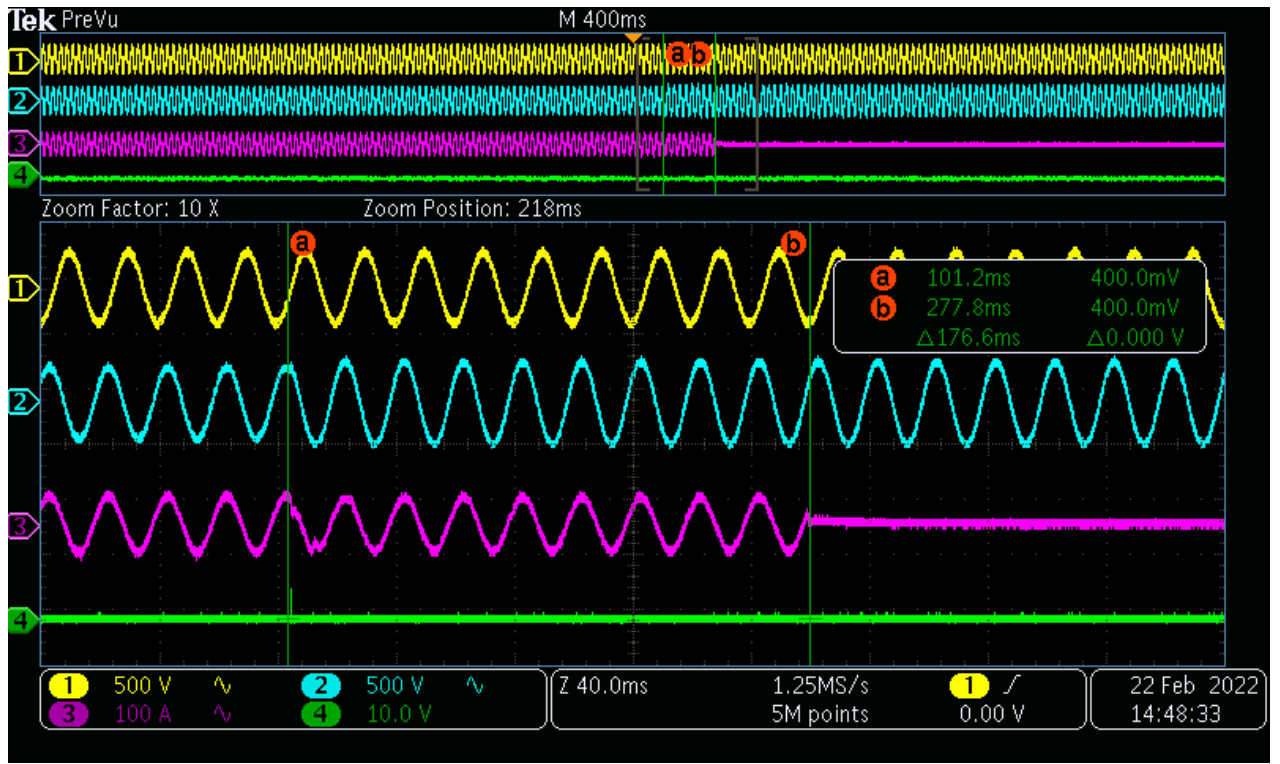

Phase C of Test 2

Trip Value

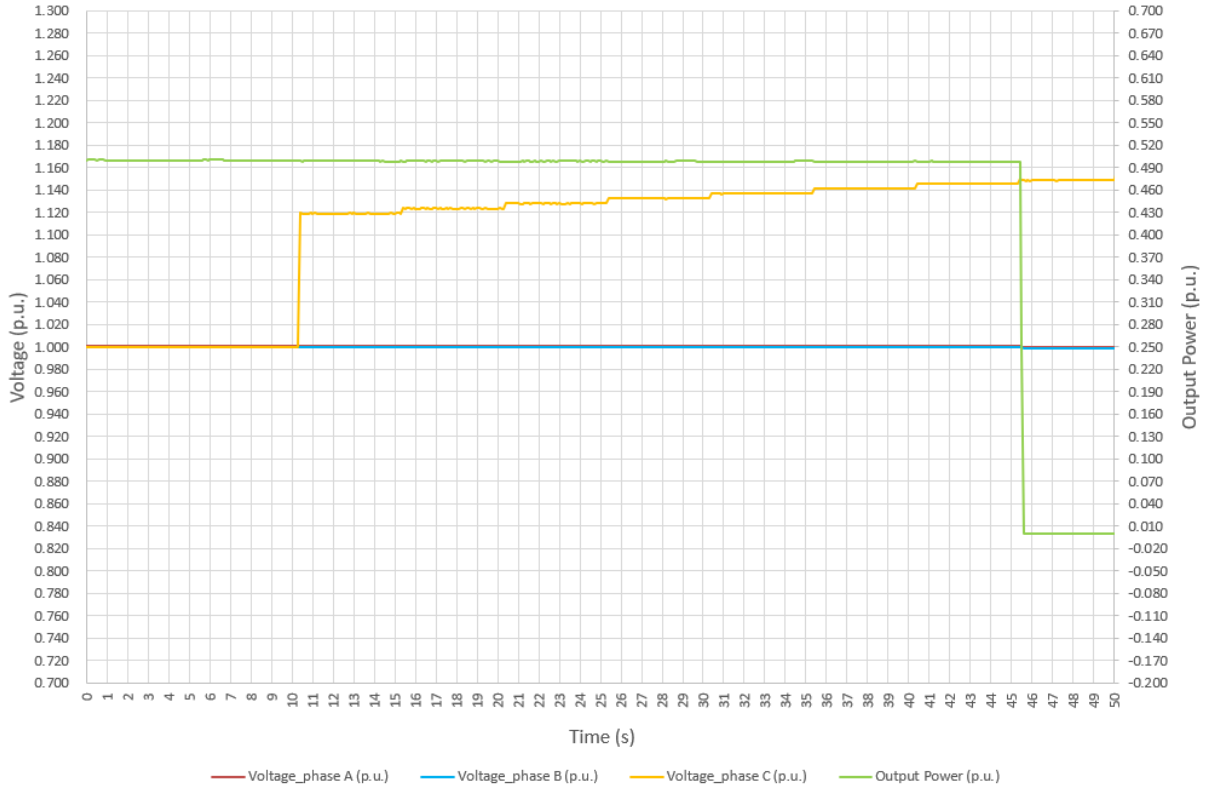

Trip Time

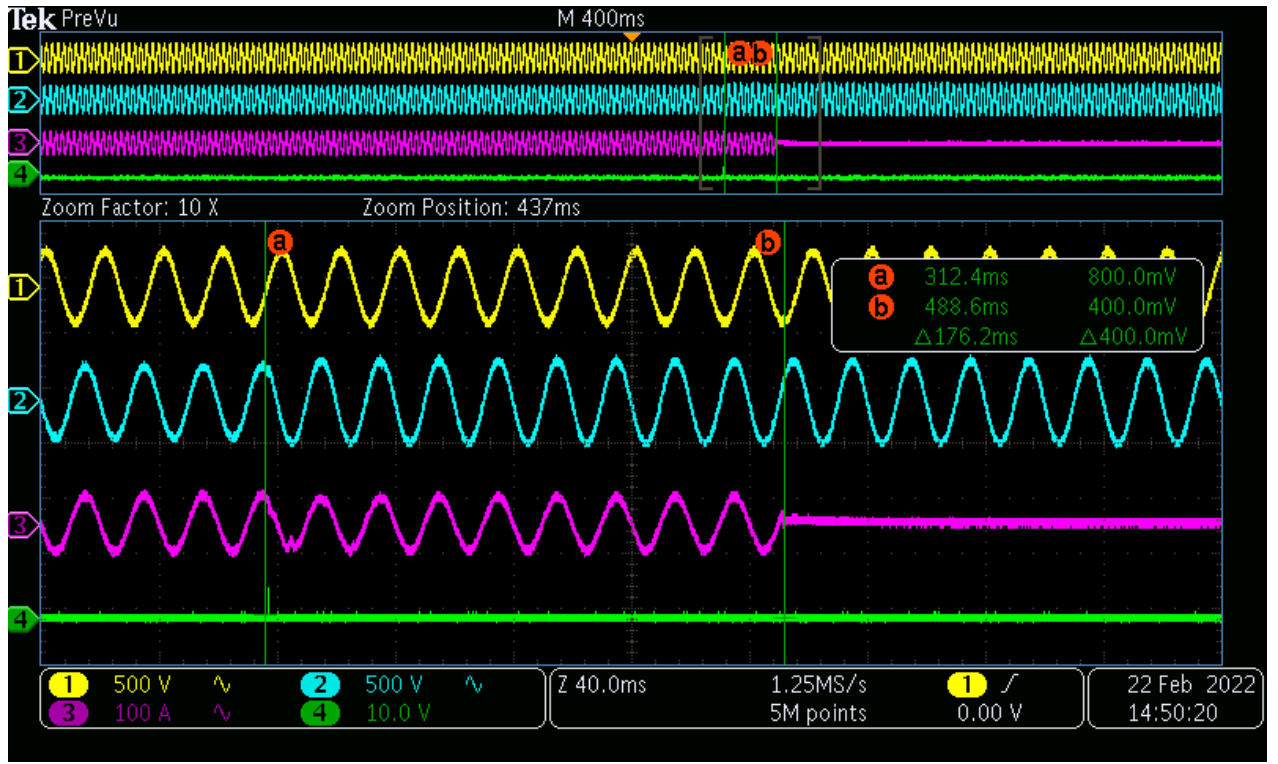

Phase C of Test 3

Trip Value



Trip Time

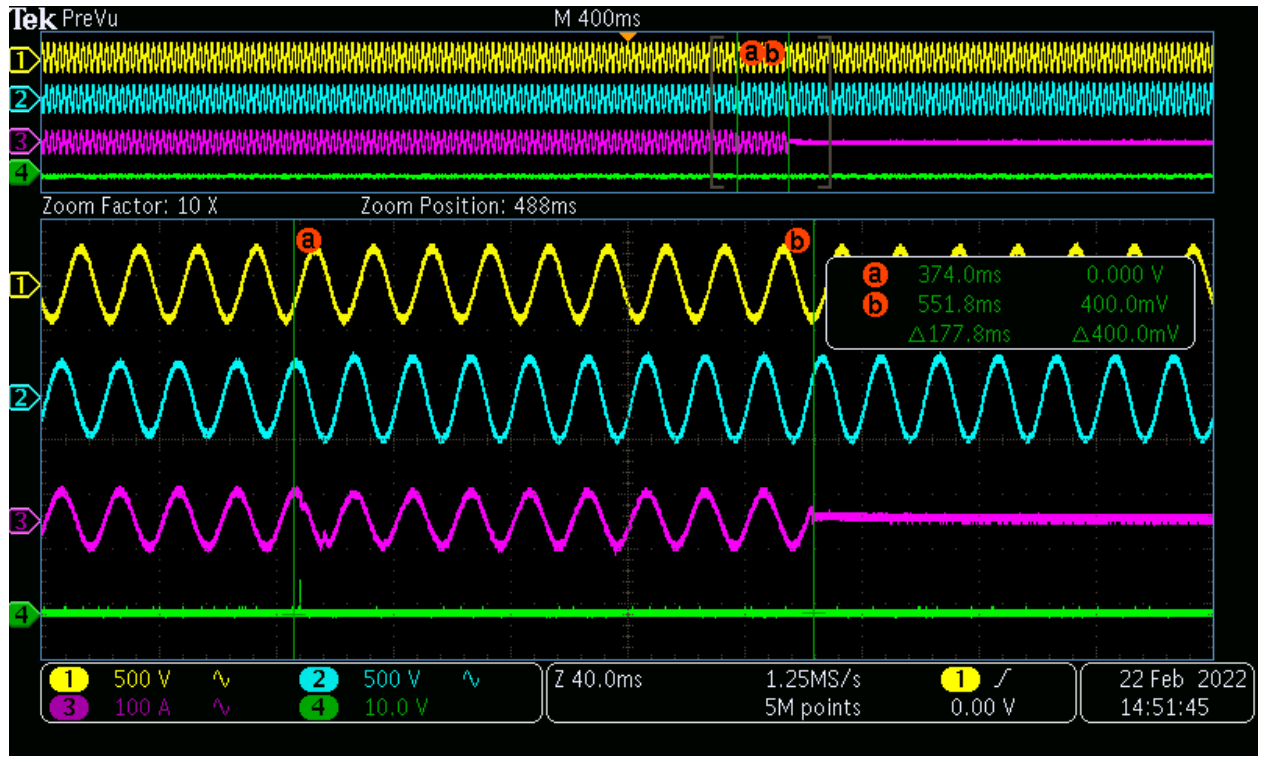

Phase ABC of Test 1

Trip Value

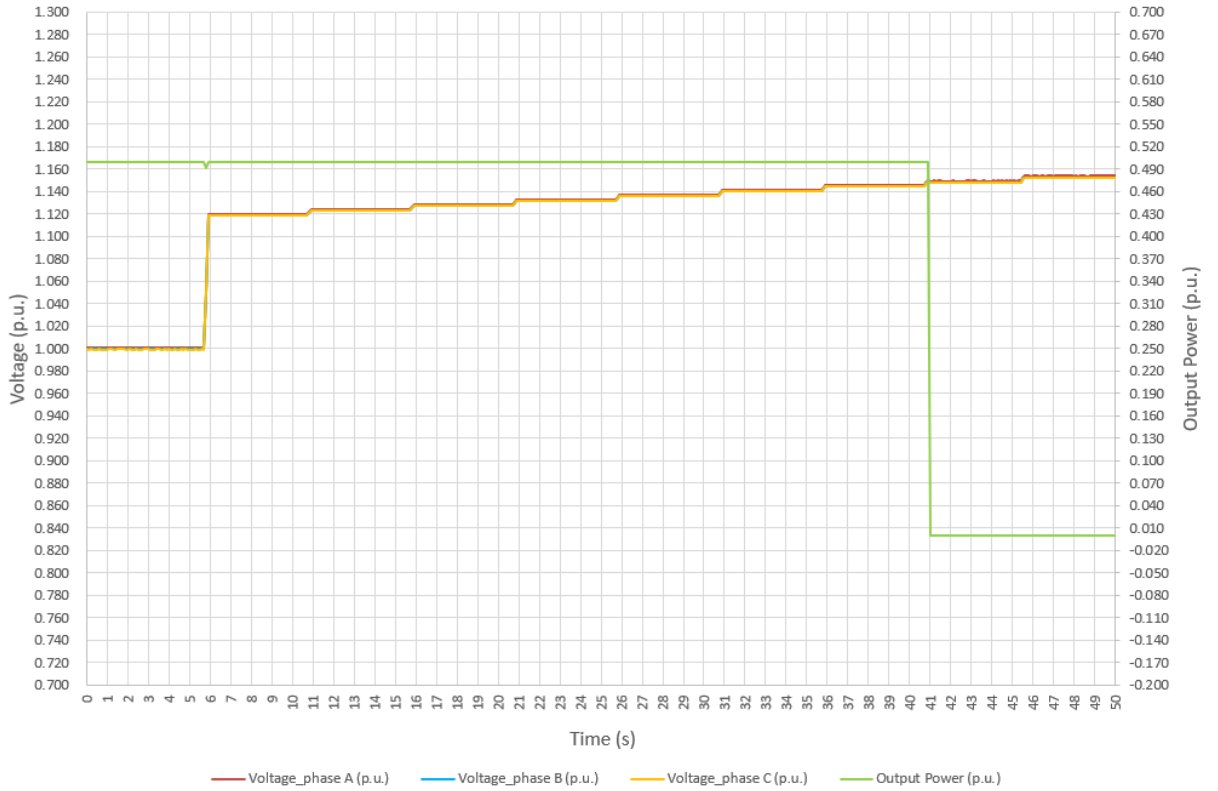

Trip Time

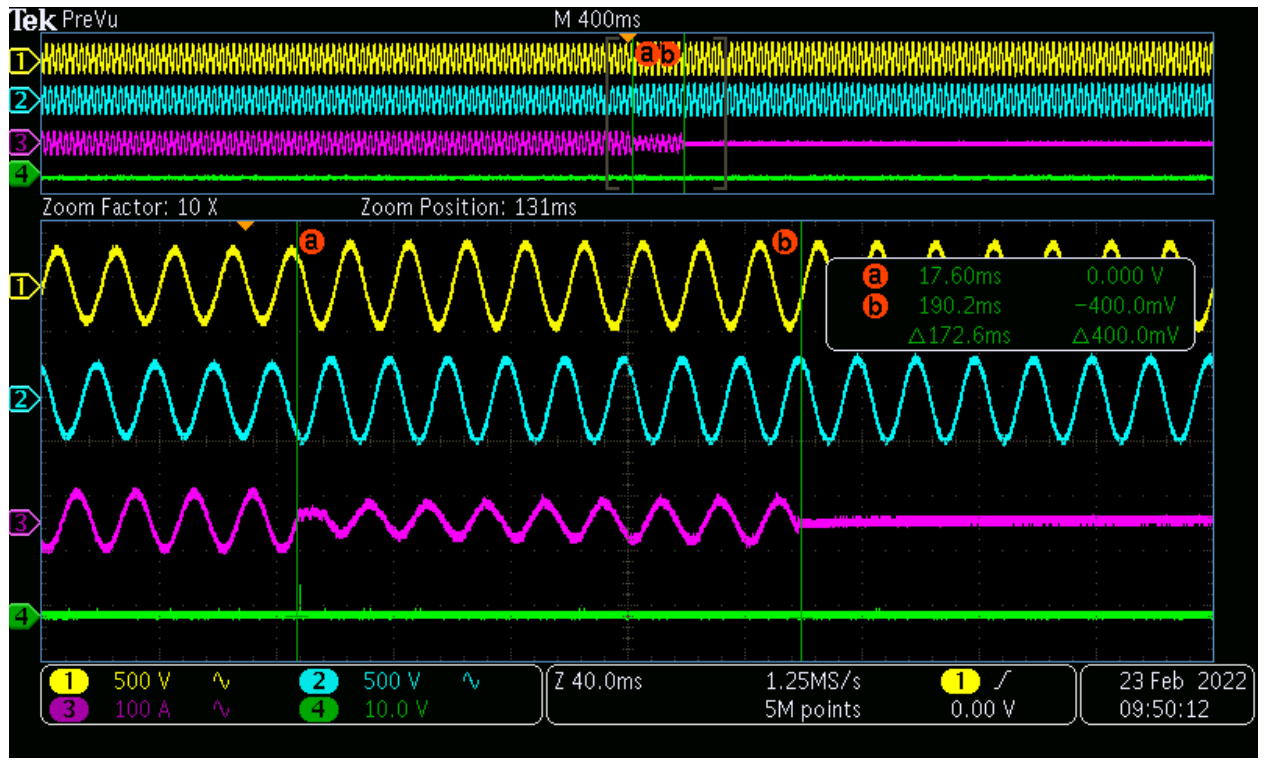

Phase ABC of Test 2

Trip Value

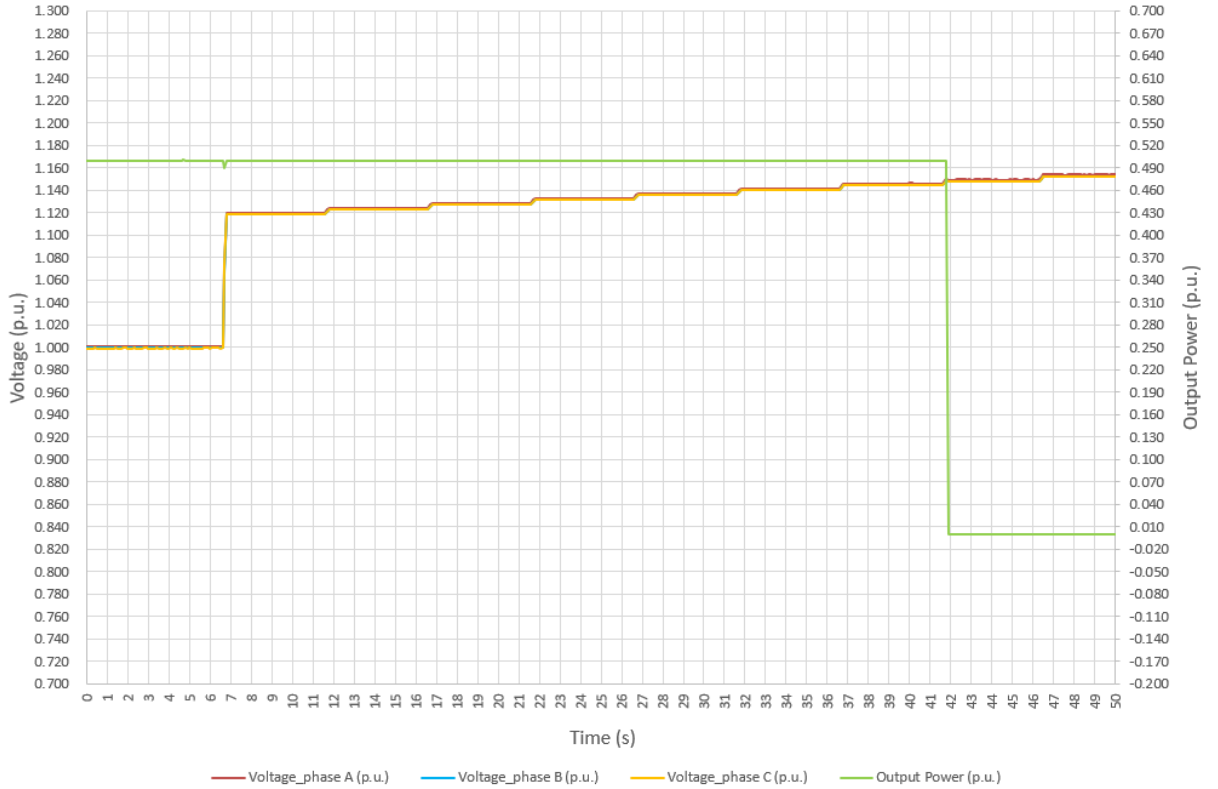

Trip Time

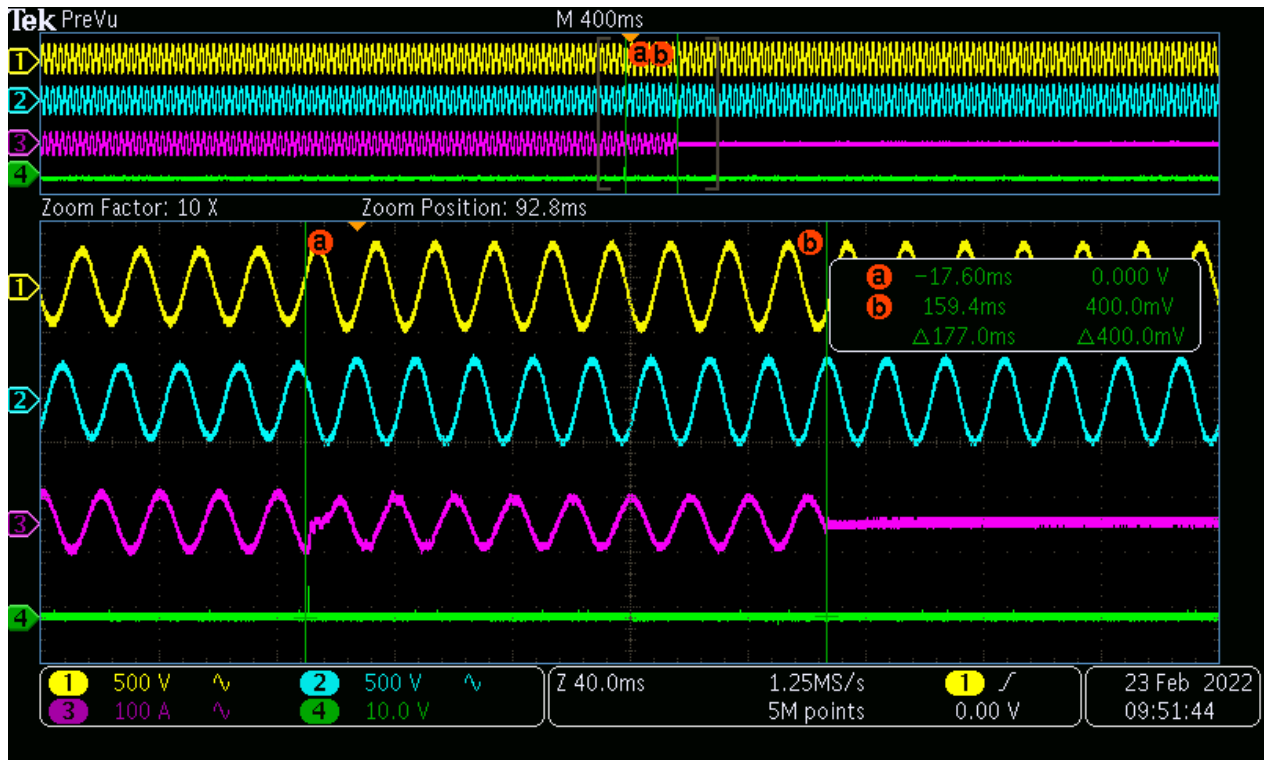

Phase ABC of Test 3

Trip Value

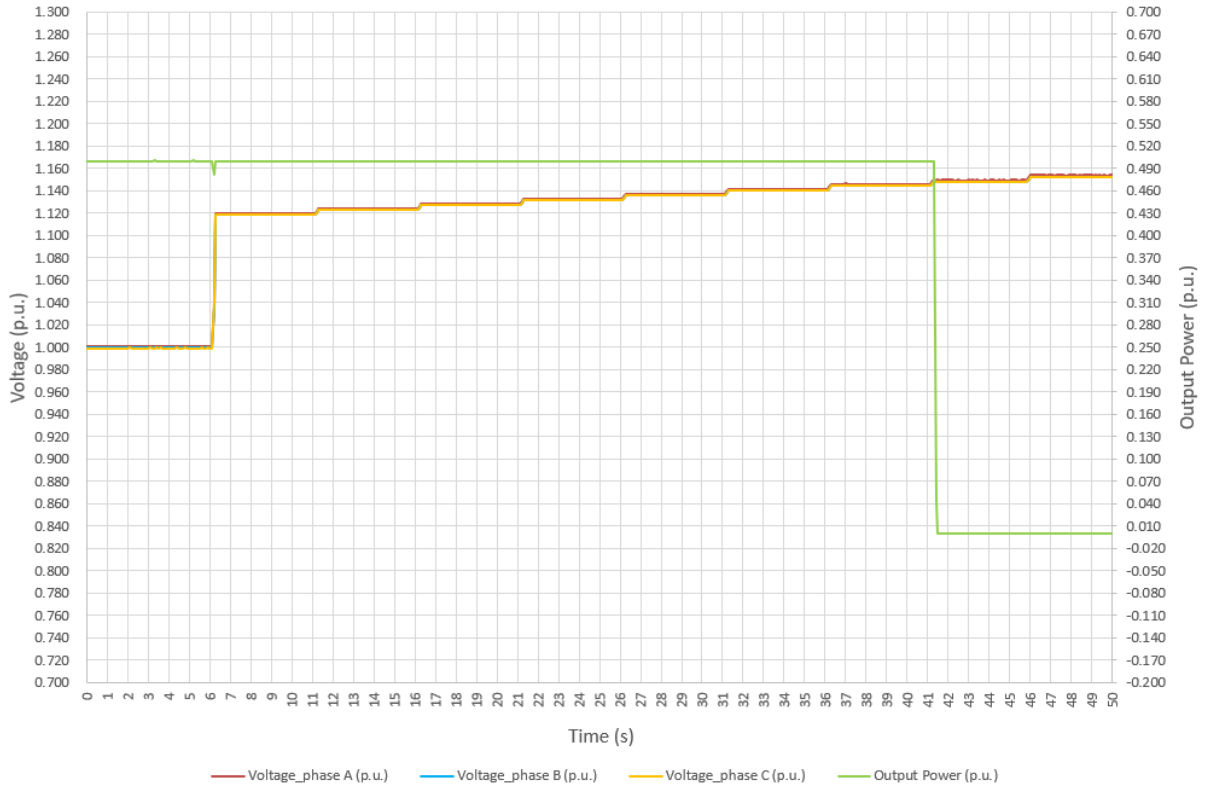

Trip Time

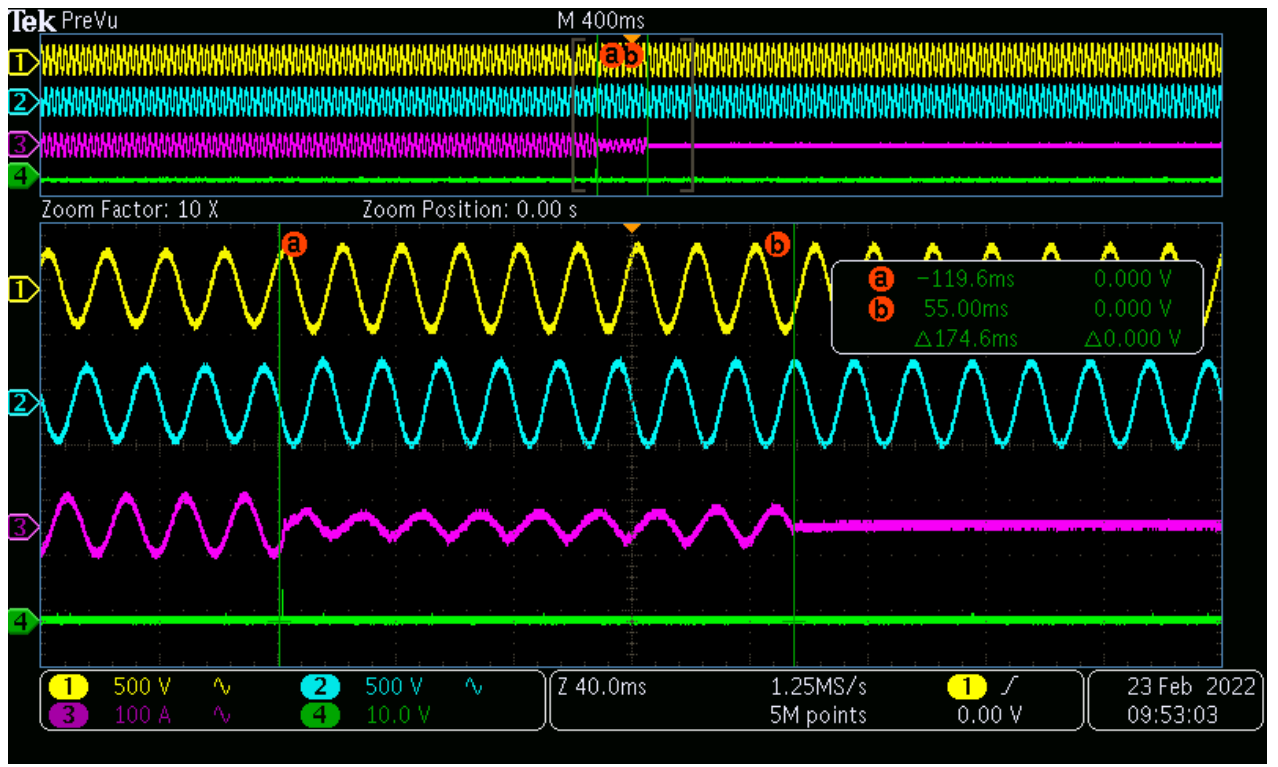

**4.6.4.3 Overvoltage 10 min mean protection (Country / Region: Poland)**

The function shall be based on the calculation of the square root of the arithmetic mean of the squared input values over 10 min. The calculation of a new 10 min value at least every 3 s is sufficient, which is then to be compared with the threshold value.

The following definitions apply to the test to verify the clause:

Overvoltage of 110%Un					
Test No.	Voltage setting (p.u.)	Voltage meas. (p.u.)	Voltage deviation (p.u.)	Trip time meas. (s)	Trip time limited
1	1.100	1.100	0.000	2.7	≤ 3.0s
2	1.100	1.100	0.000	2.8	≤ 3.0s
3	1.100	1.100	0.000	2.7	≤ 3.0s

Note: The trip voltage accuracy tolerance is ±0.01 Un.

Test results are represented at diagrams below.

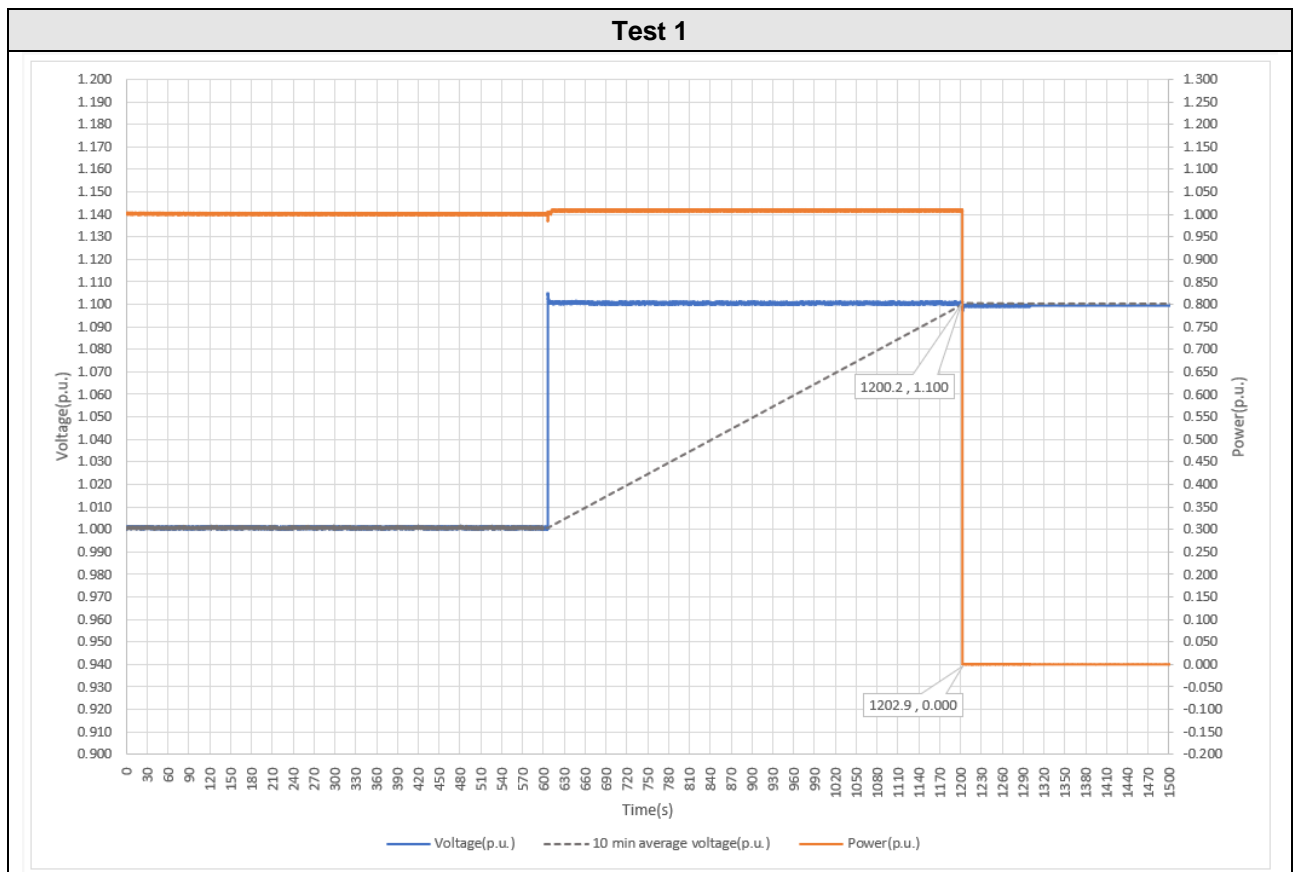

Test 2

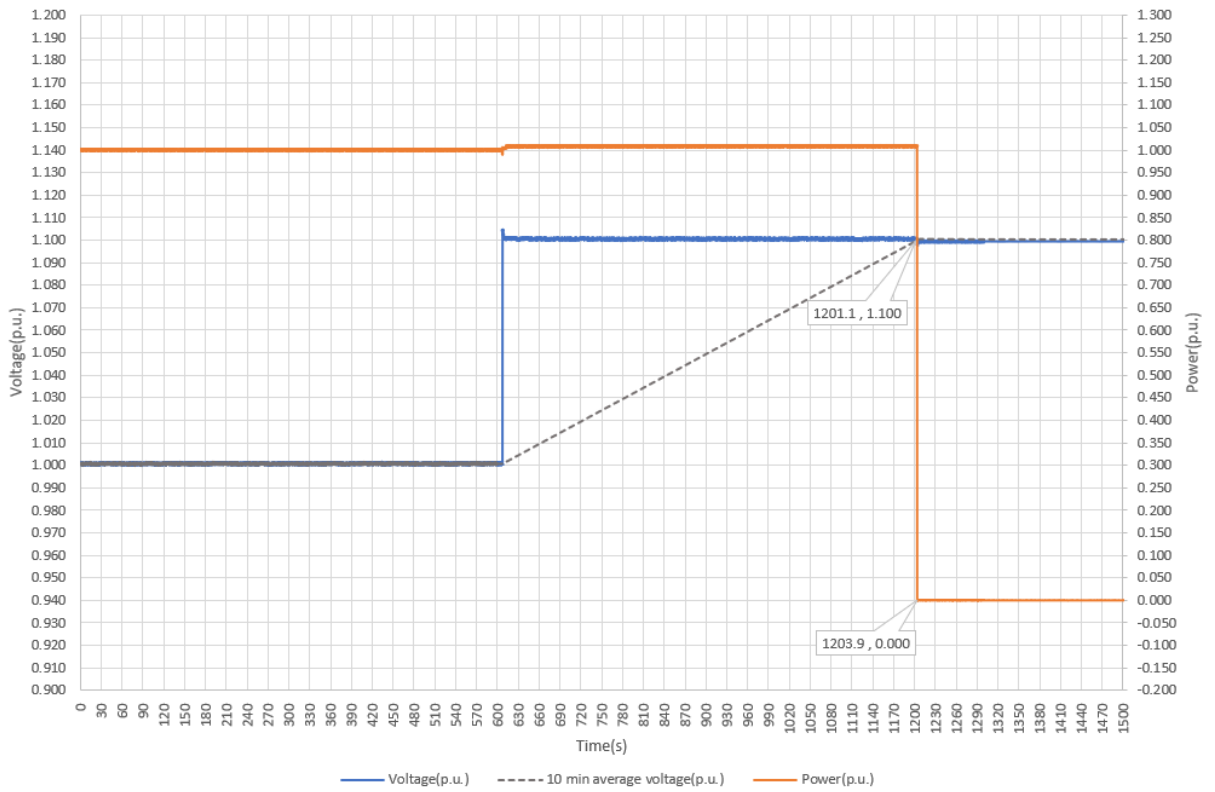

Test 3

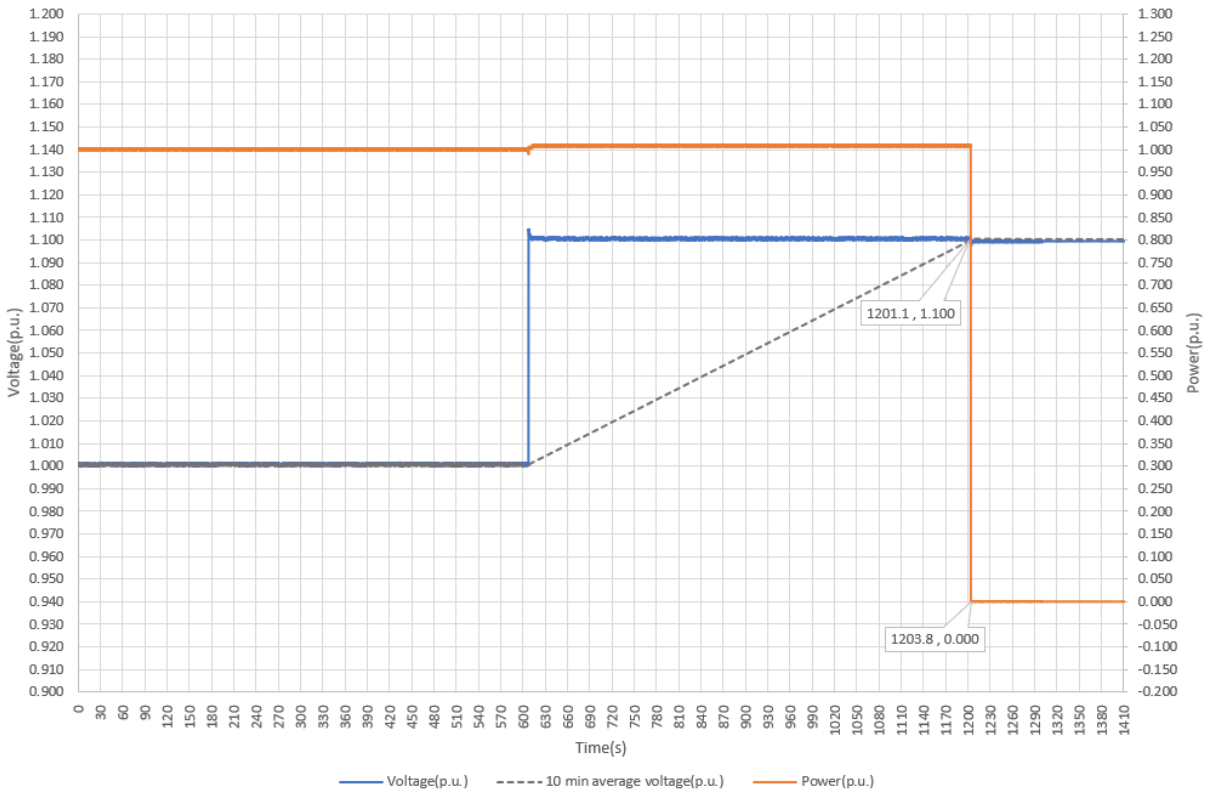



**4.6.4.4 Underfrequency protection (Country / Region: Poland)**

<b>Underfrequency</b>				
<b>Parameter</b>	<b>Settings</b>	<b>Test 1</b>	<b>Test 2</b>	<b>Test 3</b>
Trip value [Hz]	47.50	47.48	47.48	47.48
Trip time [s]	< 0.500	0.436	0.441	0.430

Test results are represented at diagrams below.

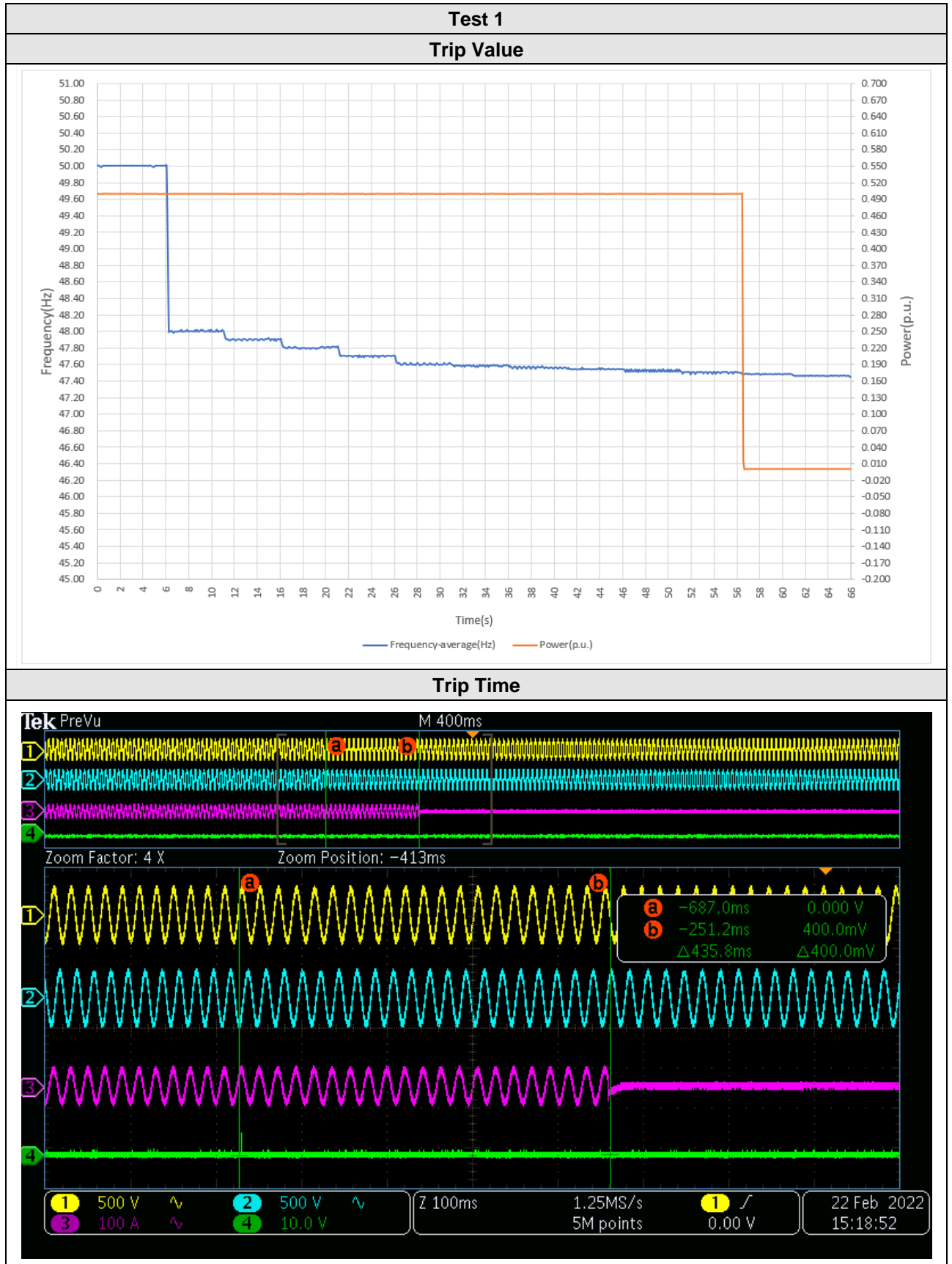

Test 2

Trip Value

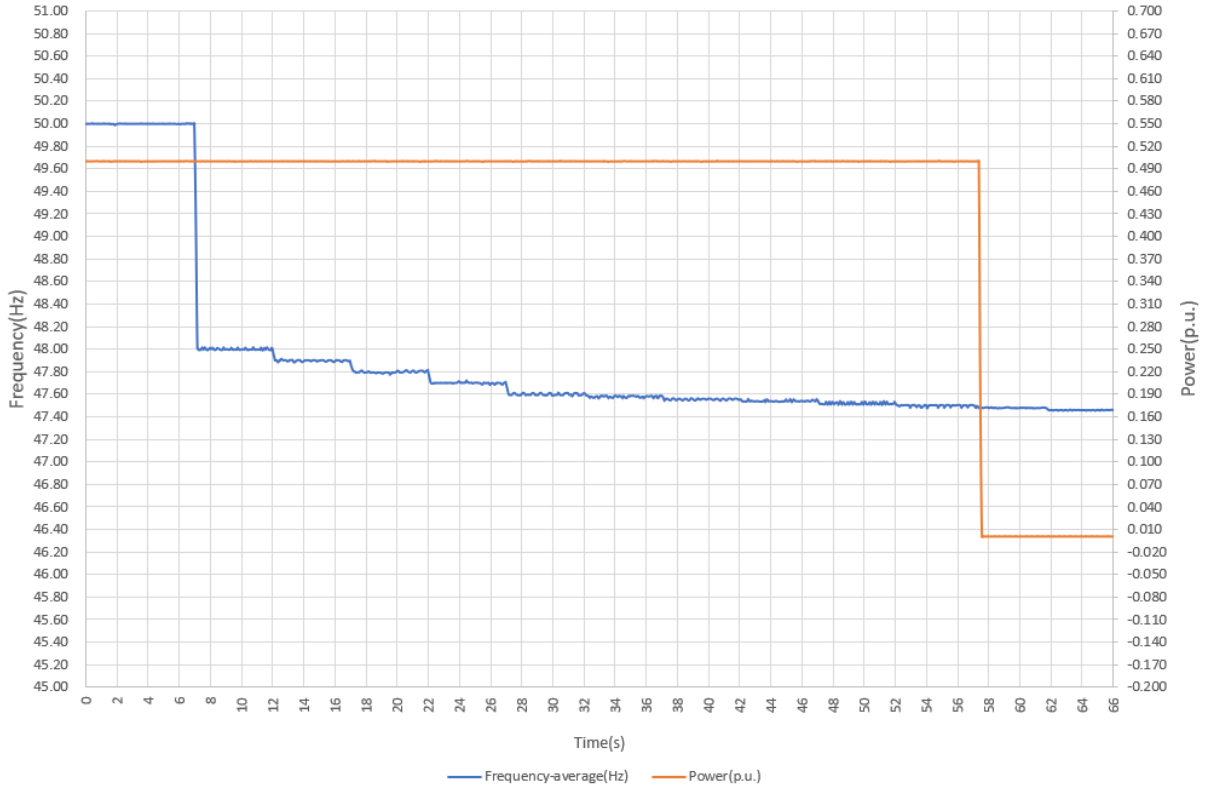

Trip Time

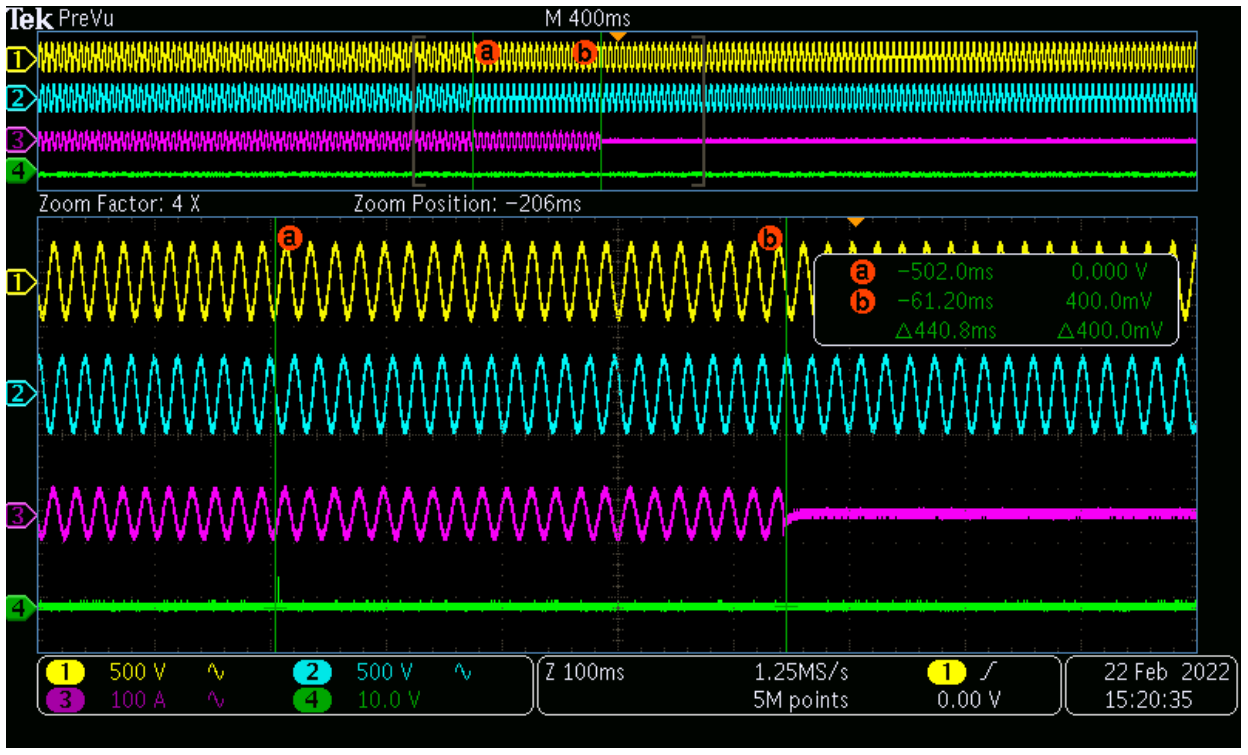

Test 3

Trip Value

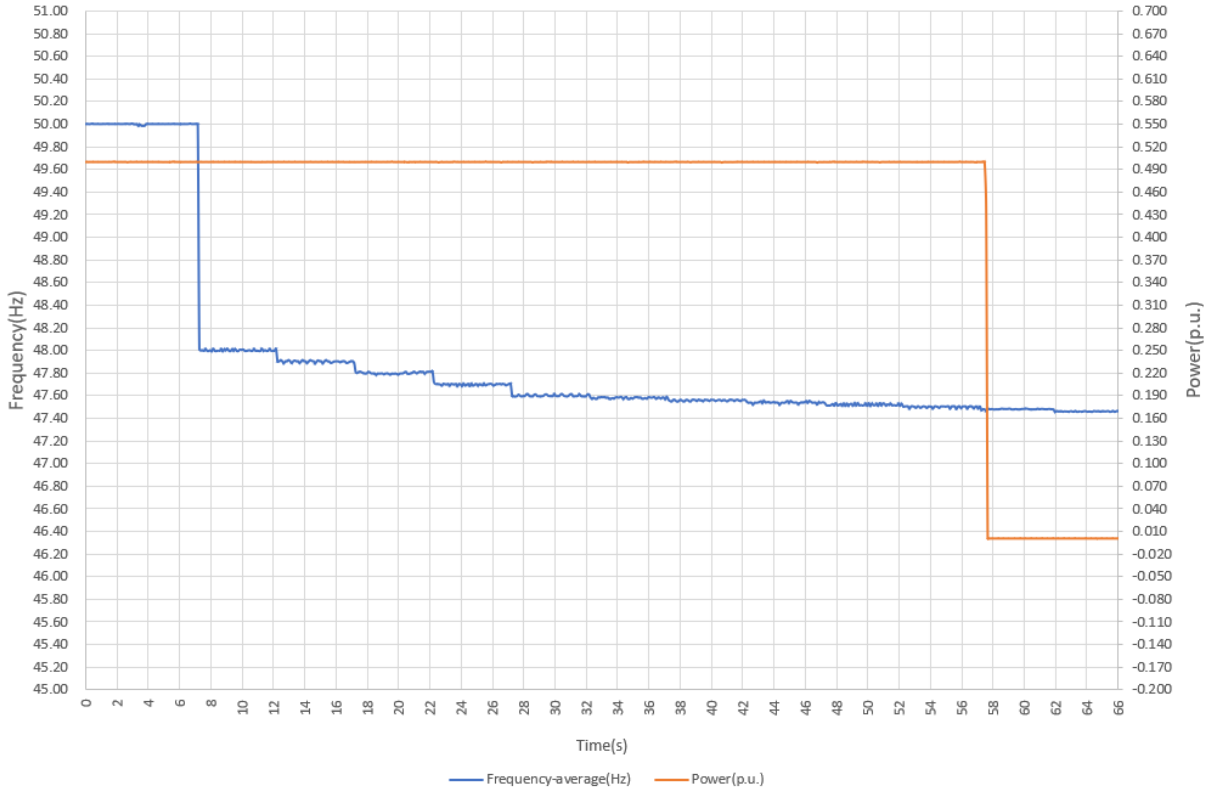

Trip Time

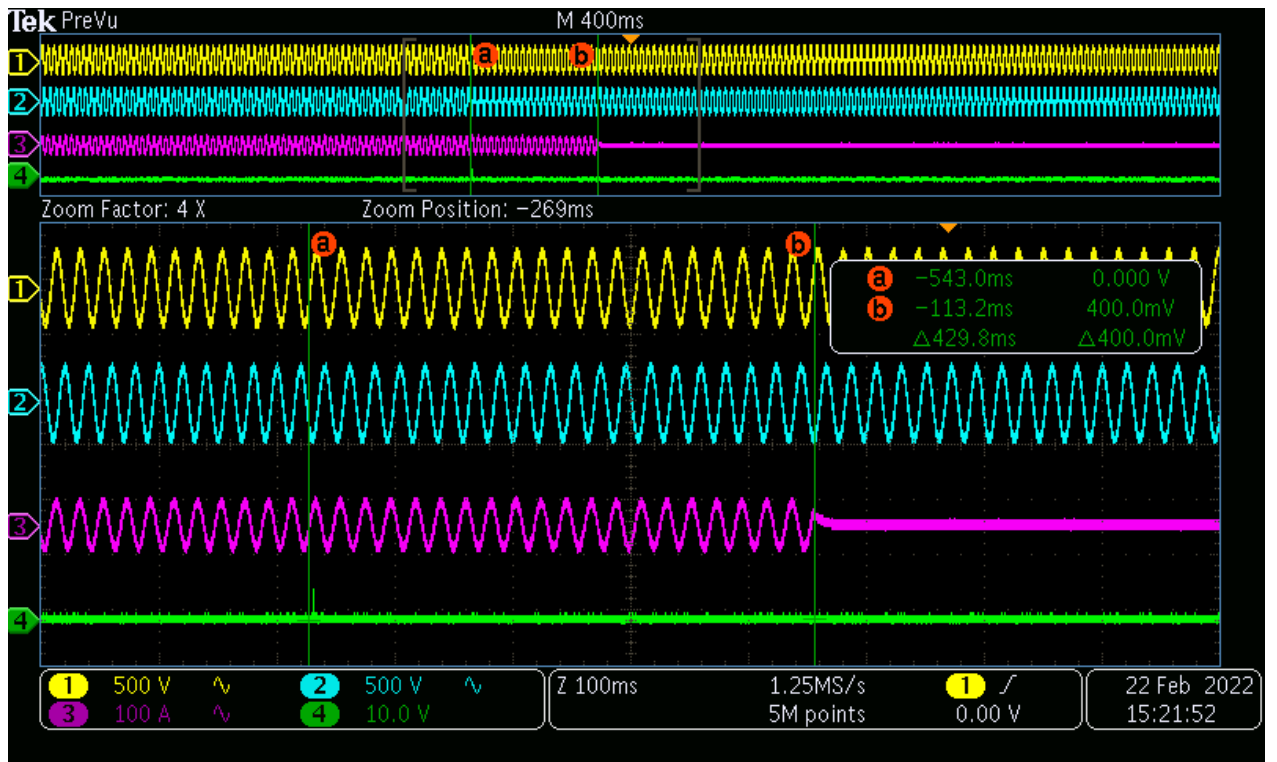

**4.6.4.5 Overfrequency protection (Country / Region: Poland)**

<b>Overfrequency</b>				
<b>Parameter</b>	<b>Settings</b>	<b>Test 1</b>	<b>Test 2</b>	<b>Test 3</b>
Trip value [Hz]	52.00	52.00	52.01	52.01
Trip time [s]	< 0.500	0.462	0.456	0.462

Test results are represented at diagrams below.

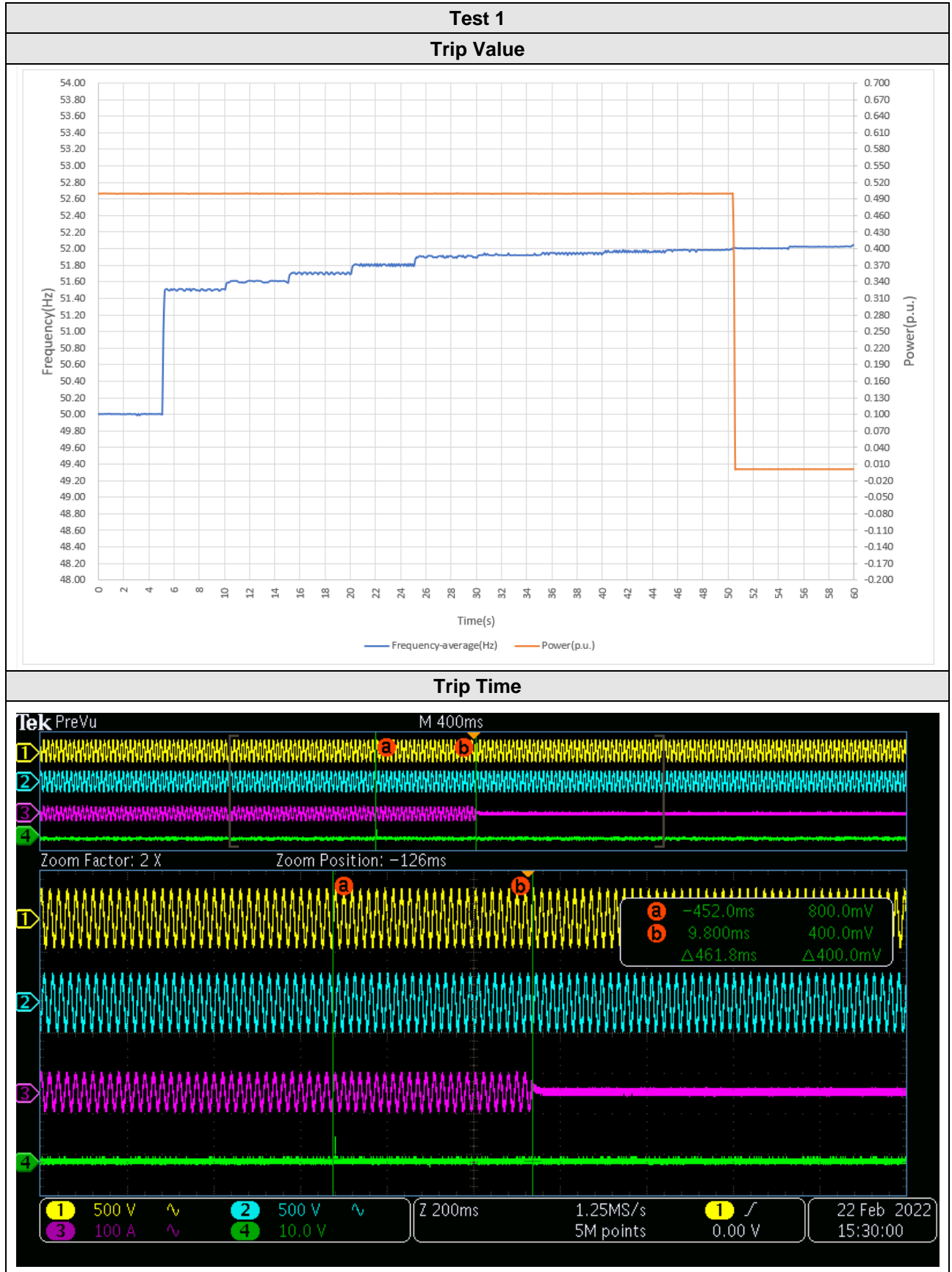

Test 2

Trip Value

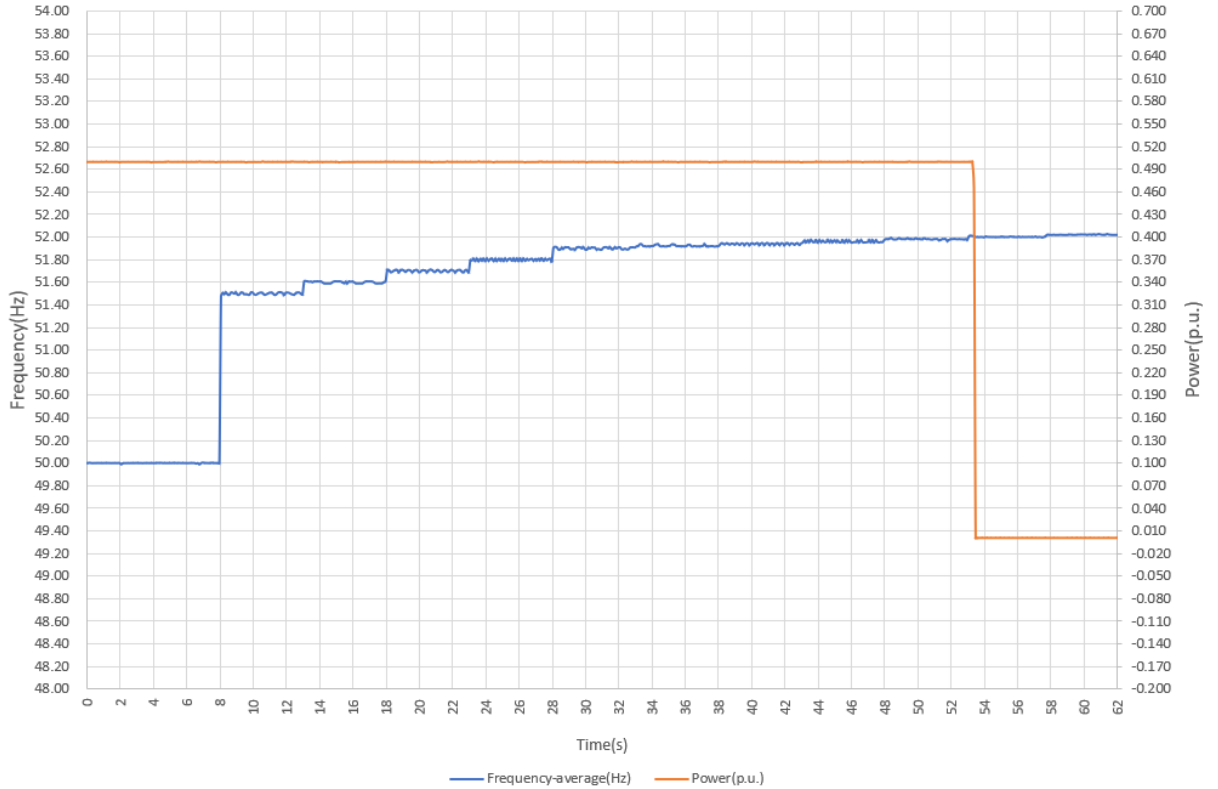

Trip Time

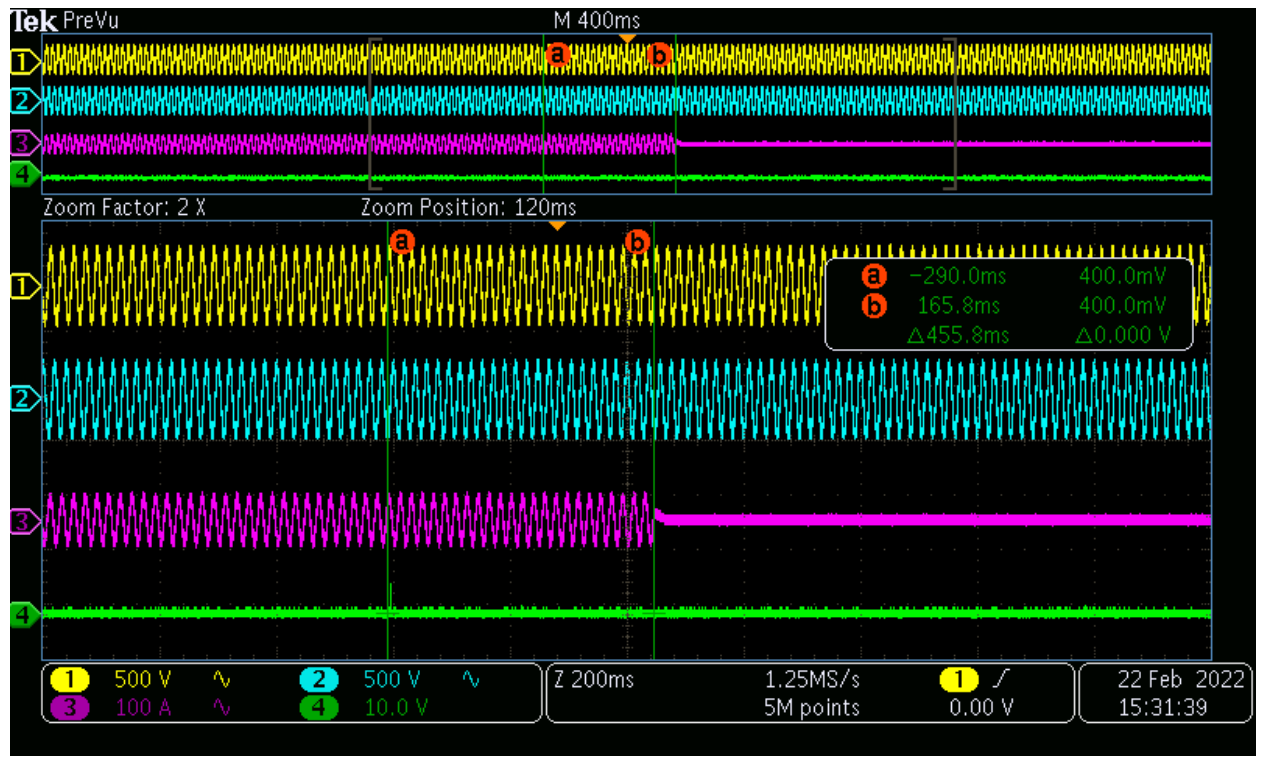

Test 3

Trip Value

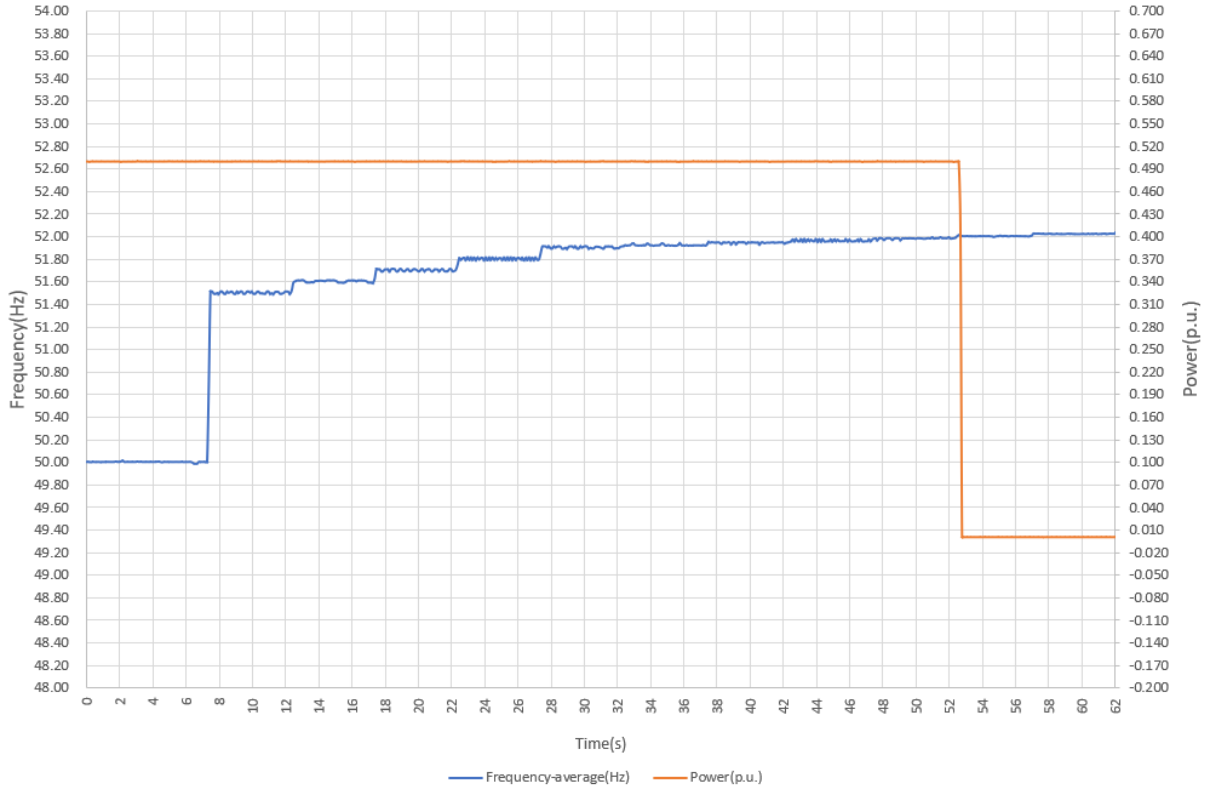

Trip Time

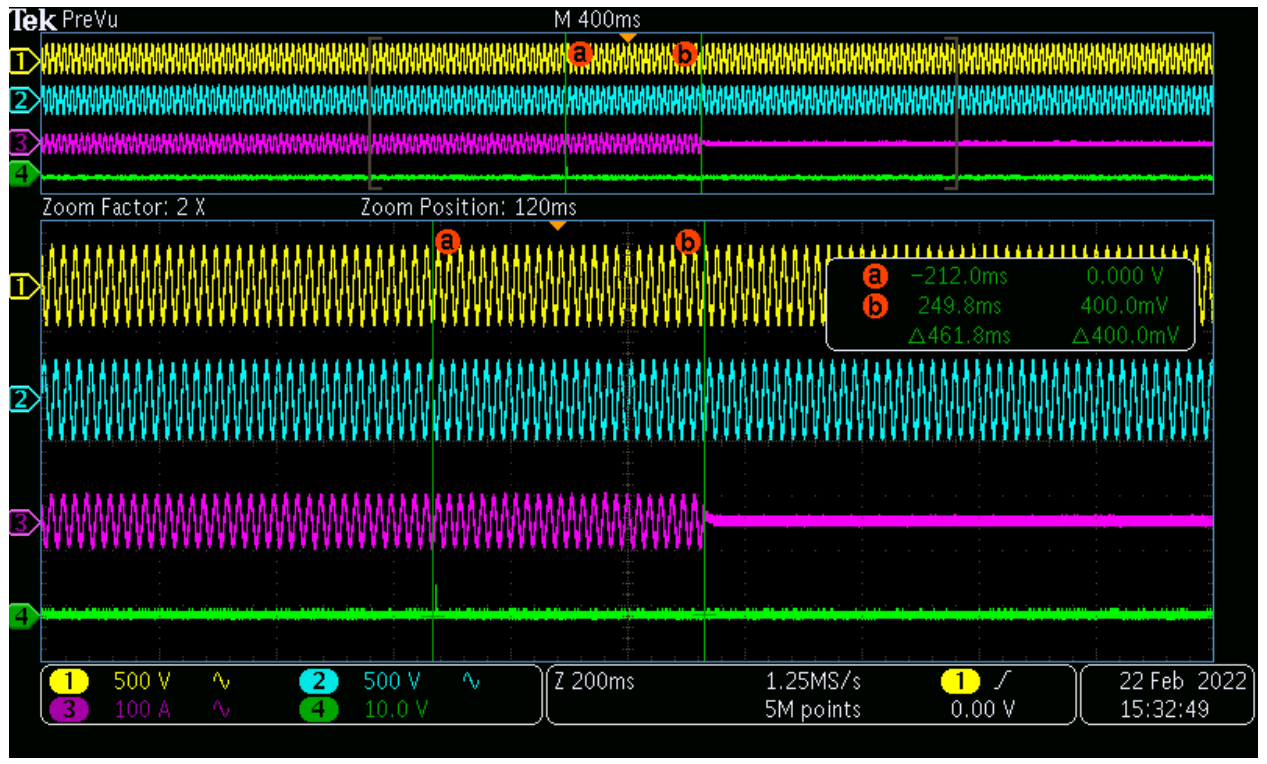



#### 4.6.5. Means to detect island situation

The test has been done according to the clause 4.9.4 of the standard.

This protection device is also able to detect islanded situations and disconnect the equipment from the grid. Active methods tested with a resonant circuit used for detecting islanding situations.

The compliances with these requirements are stated in the according to EN 62116. An EUT is considered to comply with the requirements for islanding protection when each case of recorded run-on time is less than 2 s or meets the requirements of local codes.

Table: tested condition and run-on time									
No.	P <sub>EUT</sub> (% of EUT rating)	Reactive load (% of normal)	P <sub>AC</sub>	Q <sub>AC</sub>	Run-on time (ms)	P <sub>EUT</sub> (KW)	Actual Q <sub>i</sub>	V <sub>DC</sub> (d.c.V)	Which load is selected to be adjusted (R or L)
Test condition A									
1	100	100	0	0	496	50.0	1.000	800.0	--
2	100	100	-5	-5	368	50.0	1.026	800.0	R/L
3	100	100	-5	0	483	50.0	1.049	800.0	R
4	100	100	-5	+5	408	50.0	1.074	800.0	R/L
5	100	100	0	-5	495	50.0	0.981	800.0	L
6	100	100	0	+5	466	50.0	1.026	800.0	L
7	100	100	+5	-5	393	50.0	0.940	800.0	R/L
8	100	100	+5	0	481	50.0	0.958	800.0	R
9	100	100	+5	+5	332	50.0	0.982	800.0	R/L
10	100	100	-10	+10	--	--	--	--	R/L
11	100	100	-5	+10	--	--	--	--	R/L
12	100	100	0	+10	--	--	--	--	L
13	100	100	+10	+10	--	--	--	--	R/L
14	100	100	+10	+5	--	--	--	--	R/L
15	100	100	+10	0	--	--	--	--	R
16	100	100	+10	-5	--	--	--	--	R/L
17	100	100	+10	-10	--	--	--	--	R/L
18	100	100	+5	-10	--	--	--	--	R/L
19	100	100	+5	10	--	--	--	--	R/L
20	100	100	0	-10	--	--	--	--	L
21	100	100	-5	-10	--	--	--	--	R/L
22	100	100	-10	-10	--	--	--	--	R/L
23	100	100	-10	-5	--	--	--	--	R/L
24	100	100	-10	0	--	--	--	--	R/L
25	100	100	-10	+5	--	--	--	--	R/L
Test condition B									
26	66	66	0	0	494	33.2	0.999	590.5	--
27	66	66	0	-5	404	33.2	0.975	590.5	L
28	66	66	0	-4	427	33.2	0.979	590.5	L
29	66	66	0	-3	439	33.2	0.988	590.5	L
30	66	66	0	-2	469	33.2	0.993	590.5	L
31	66	66	0	-1	489	33.2	0.995	590.5	L
32	66	66	0	1	489	33.2	1.003	590.5	L
33	66	66	0	2	475	33.2	1.011	590.5	L
34	66	66	0	3	469	33.2	1.015	590.5	L
35	66	66	0	4	433	33.2	1.020	590.5	L
36	66	66	0	5	388	33.2	1.024	590.5	L

**Table: tested condition and run-on time**

No.	P <sub>EUT</sub> (% of EUT rating)	Reactive load (% of normal)	P <sub>AC</sub>	Q <sub>AC</sub>	Run-on time (ms)	P <sub>EUT</sub> (KW)	Actual Q <sub>f</sub>	V <sub>DC</sub> (d.c.V)	Which load is selected to be adjusted (R or L)
Test condition C									
37	33	33	0	0	499	16.6	1.001	342.1	--
38	33	33	0	-5	376	16.6	0.977	342.1	L
39	33	33	0	-4	392	16.6	0.979	342.1	L
40	33	33	0	-3	416	16.6	0.984	342.1	L
41	33	33	0	-2	449	16.6	0.988	342.1	L
42	33	33	0	-1	455	16.6	0.994	342.1	L
43	33	33	0	1	492	16.6	1.006	342.1	L
44	33	33	0	2	415	16.6	1.009	342.1	L
45	33	33	0	3	405	16.6	1.012	342.1	L
46	33	33	0	4	397	16.6	1.018	342.1	L
47	33	33	0	5	350	16.6	1.022	342.1	L

Remark:

For test condition A:

If any of the recorded run-on times are longer than the one recorded for the rated balance condition, then the non-shaded parameter combinations also require testing.

For test condition B and C:

If run-on times are still increasing at the 95 % or 105 % points, additional 1 % increments is taken until run-on times begin decreasing.

**Test Condition A**

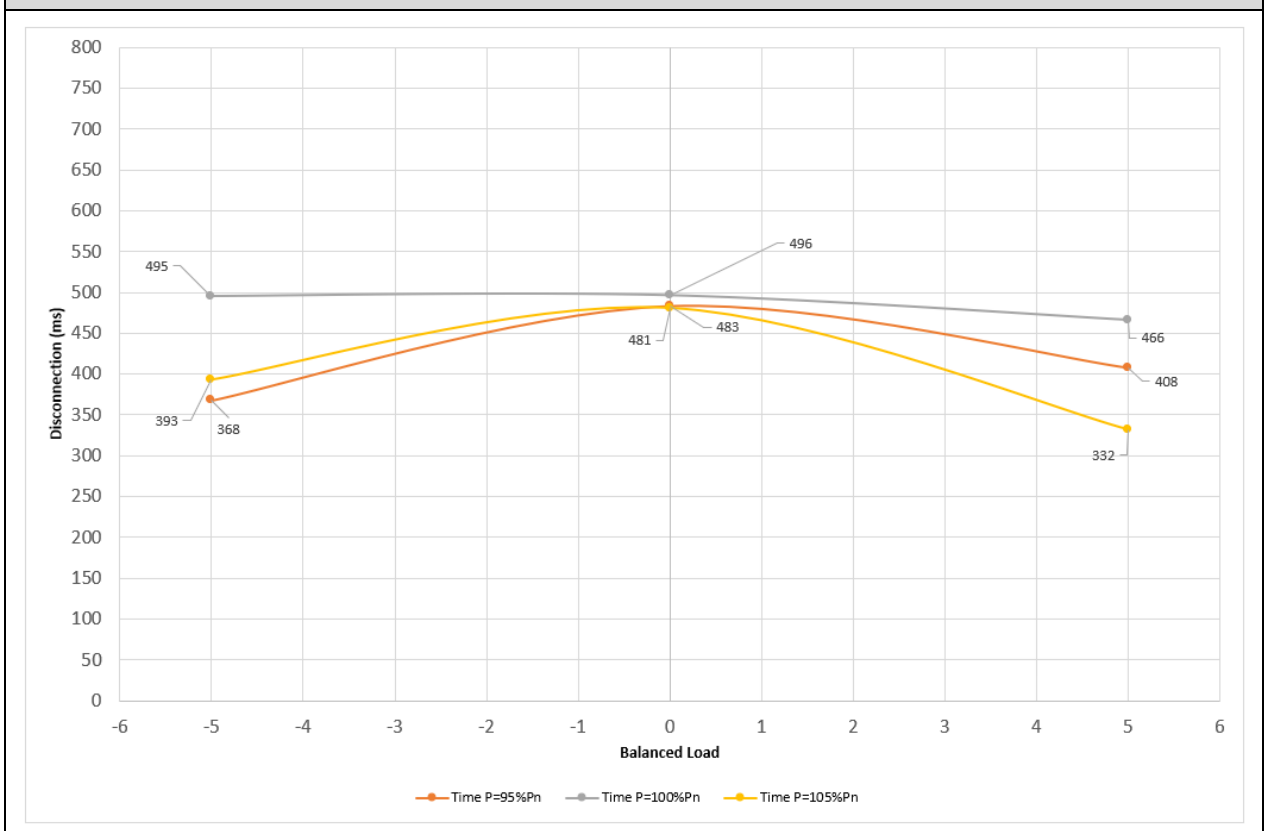

**Test Condition B**

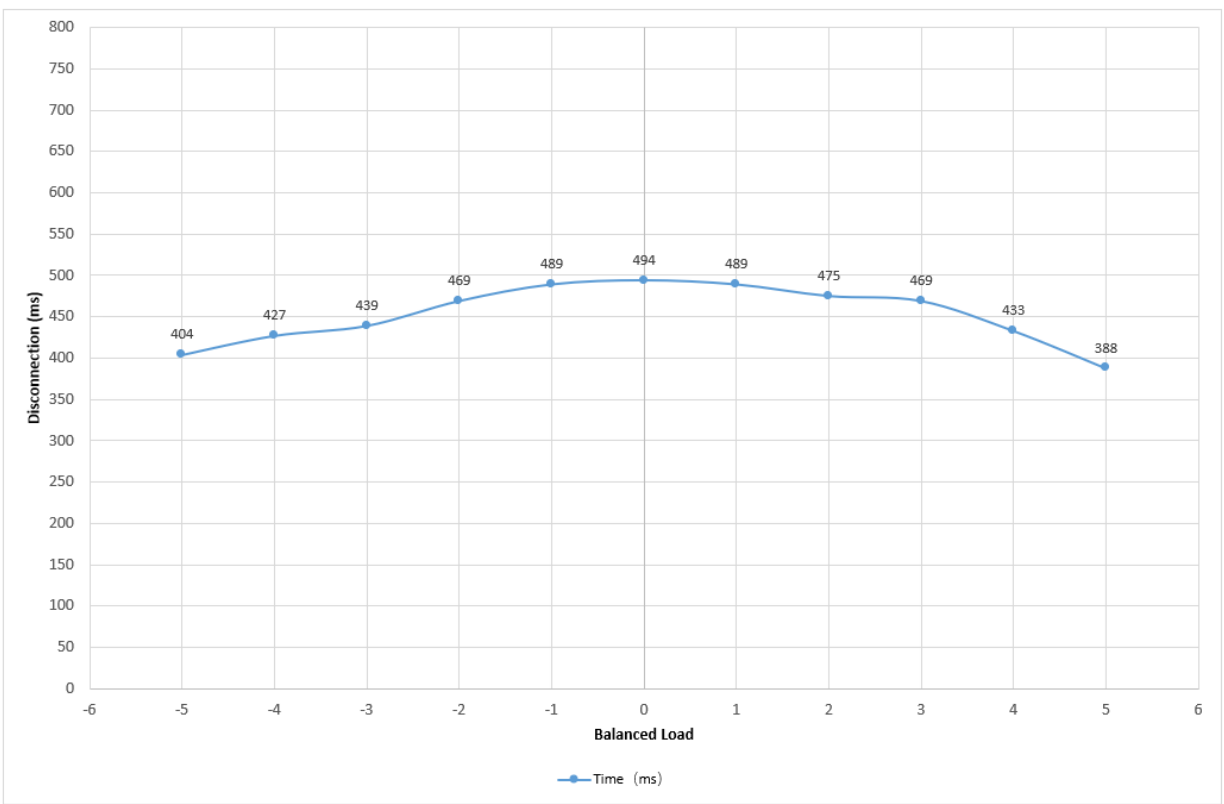

**Test Condition C**

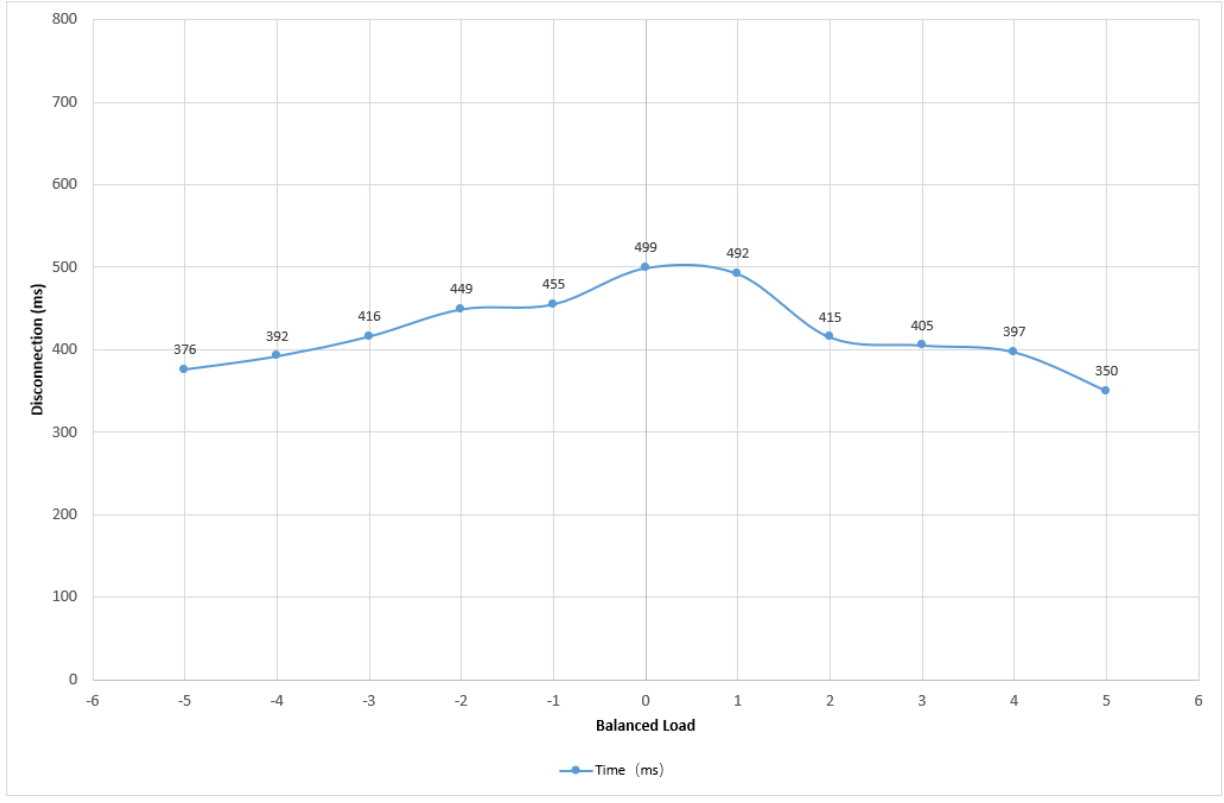

#### 4.6.6. Digital input to the interface protection

The test has been done according to the clause 4.9.5 of the standard.

The interface protection shall have at least two configurable digital inputs, EUT used active methods tested with a resonant circuit and ROCOF to comply to the clause.

#### 4.7. CONNECTION AND STARTING TO GENERATE ELECTRICAL POWER

The test has been done according to the clause 4.10 of the standard.

##### 4.7.1. Automatic reconnection after tripping

The test has been done according to the clause 4.10.2 of the standard.

The frequency range, the voltage range, the observation time shall be adjustable in the range according to Table 3 column 2. If no settings are specified by the DSO and the responsible party, the default settings for the reconnection after tripping of the interface protection are according to Table 3 column 3.

**Table 3 — Automatic reconnection after tripping**

Parameter	Range	Default setting
Lower frequency	47,0Hz – 50,0Hz	49,5Hz
Upper frequency	50,0Hz – 52,0Hz	50,2Hz
Lower voltage	50% – 100%U <sub>n</sub>	85 % U <sub>n</sub>
Upper voltage	100% – 120% U <sub>n</sub>	110 % U <sub>n</sub>
Observation time	10s – 600s	60s
Active power increase gradient	6% – 3000%/min	10%/min

The following definitions apply to the test to verify the clause:

Disconnection Setting		Reconnection Setting		Setting Reconnection time (s) <sup>(1)</sup>	Meas. Reconnection time (s)	Setting gradient (%Pn/min)	Meas. gradient (%Pn/min)
U= 115 %Un	Yes	U = 110 %Un	Yes	60.0	63.4	6.0	5.2
U = 84 %Un	Yes	U = 85 %Un	Yes	10.0	13.8	10.0	9.2
f = 52.00 Hz	Yes	f = 50.20 Hz	Yes	600.0	606.4	3000.0	1762.9 <sup>(1)</sup>
f = 47.50 Hz	Yes	f = 49.50 Hz	Yes	100.0	103.6	10.0	9.3

<sup>(1)</sup> This is the maximum gradient which can be measured for the setting of 3000.0 %Pn/min.

Overvoltage re-connection

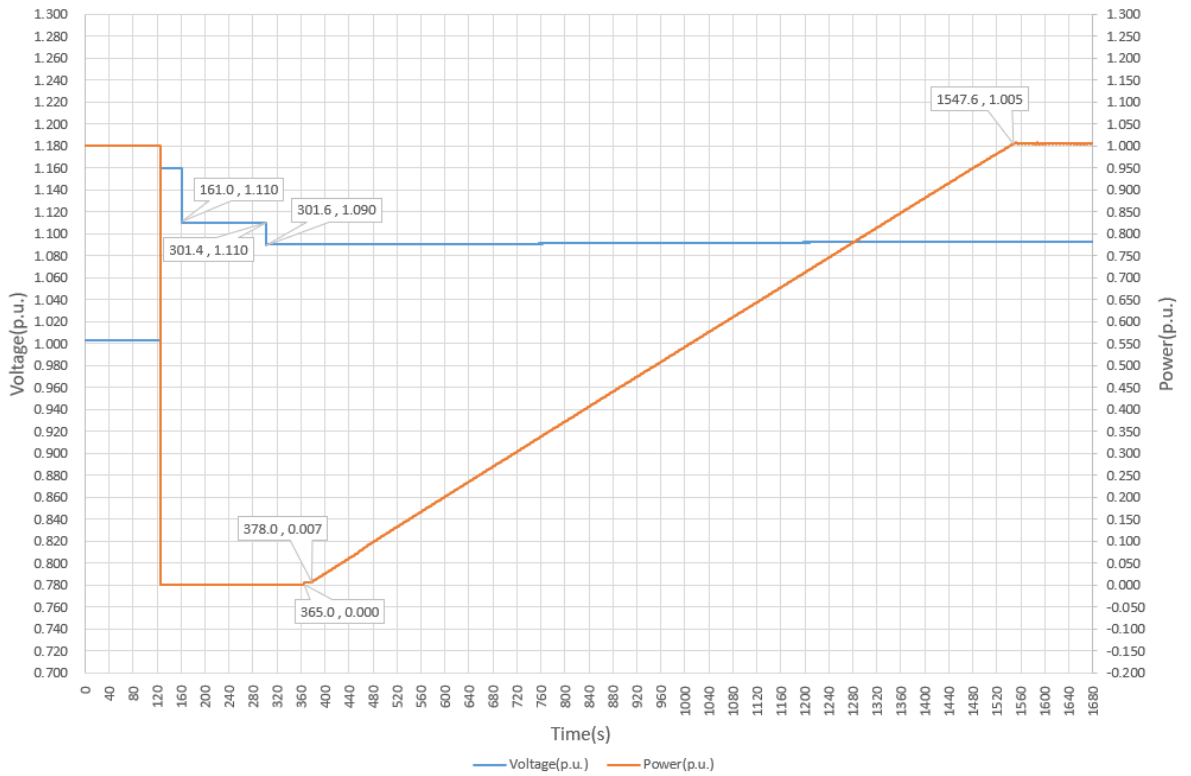

Undervoltage re-connection



Overfrequency re-connection

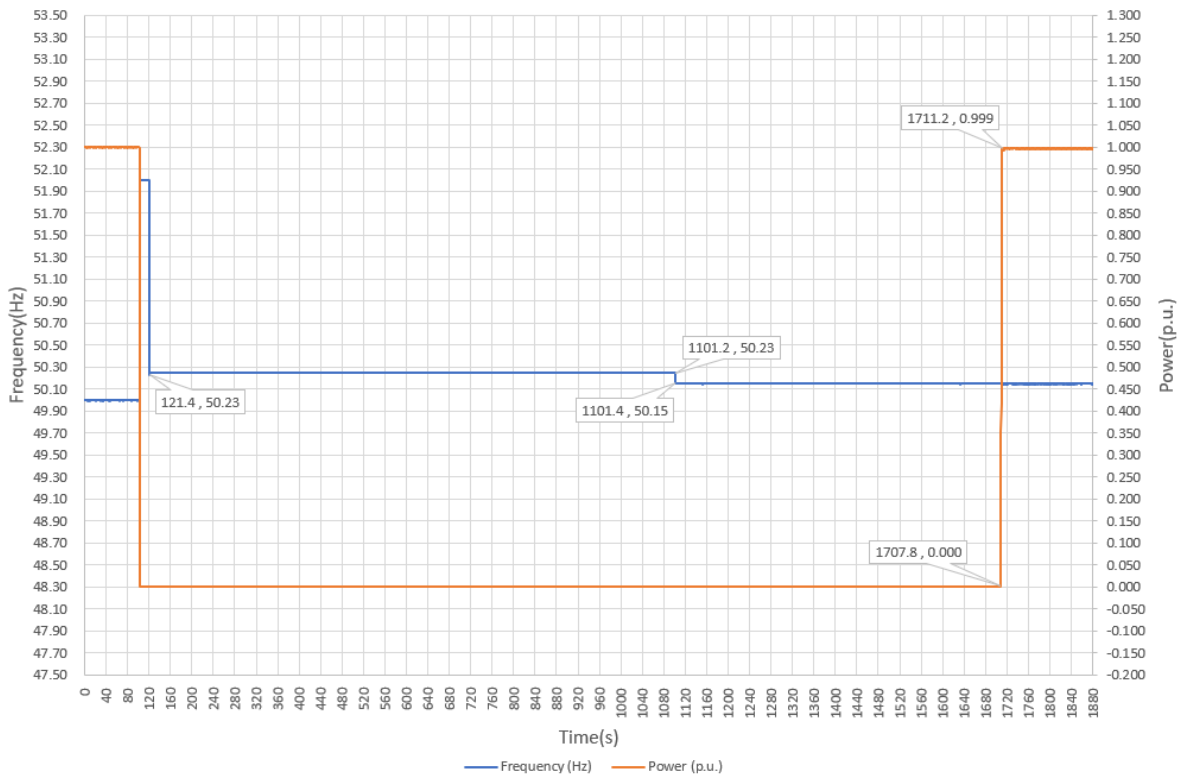

Underfrequency re-connection

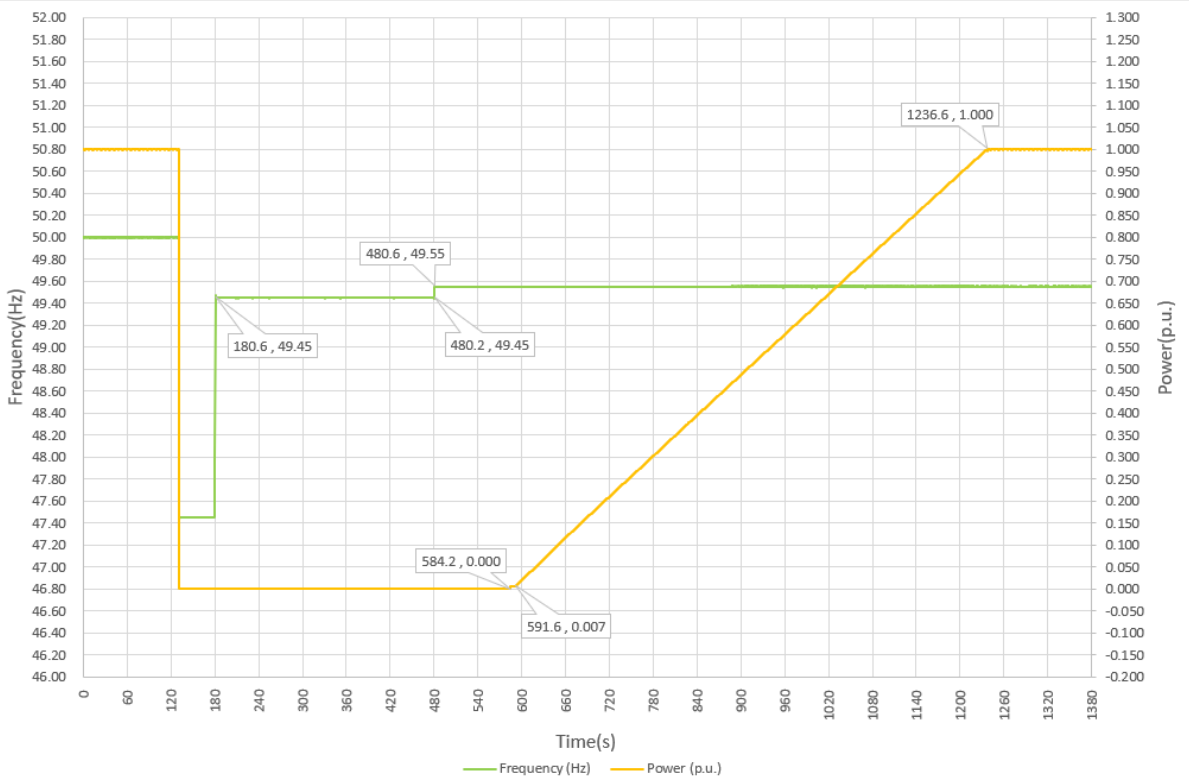

#### 4.7.2. Starting to generate electrical power

The test has been done according to the clause 4.10.3 of the standard.

The frequency range, the voltage range, the observation time shall be adjustable in the range according to Table 4 column 2. If no settings are specified by the DSO and the responsible party, the default settings for connection or starting to generate electrical power due to normal operational startup or activity are according to Table 4 column 3.

**Table 4 — Starting to generate electrical power**

Parameter	Range	Default setting
Lower frequency	47,0Hz – 50,0Hz	49,5Hz
Upper frequency	50,0Hz – 52,0Hz	50,1Hz
Lower voltage	50% – 100% $U_n$	85 % $U_n$
Upper voltage	100% – 120% $U_n$	110 % $U_n$
Observation time	10s – 600s	60s
Active power increase gradient	6% – 3000%/min	disabled

The following definitions apply to the test to verify the clause:

Connection		Setting Connection time (s)	Meas. Connection time (s)	Setting gradient (%Pn/min)	Meas. gradient (%Pn/min)
$U < 110 \% U_n$	Yes	60.0	63.6	6.0	5.1
$85 \% < U$	Yes	10.0	13.8	10.0	9.2
$f < 50.10 \text{ Hz}$	Yes	600.0	605.8	3000.0	1766.5 <sup>(1)</sup>
$49.50 < f$	Yes	100.0	103.6	10.0	9.3

<sup>(1)</sup> This is the maximum gradient which can be measured for the setting of 3000.0 %Pn/min.

Overvoltage Connection

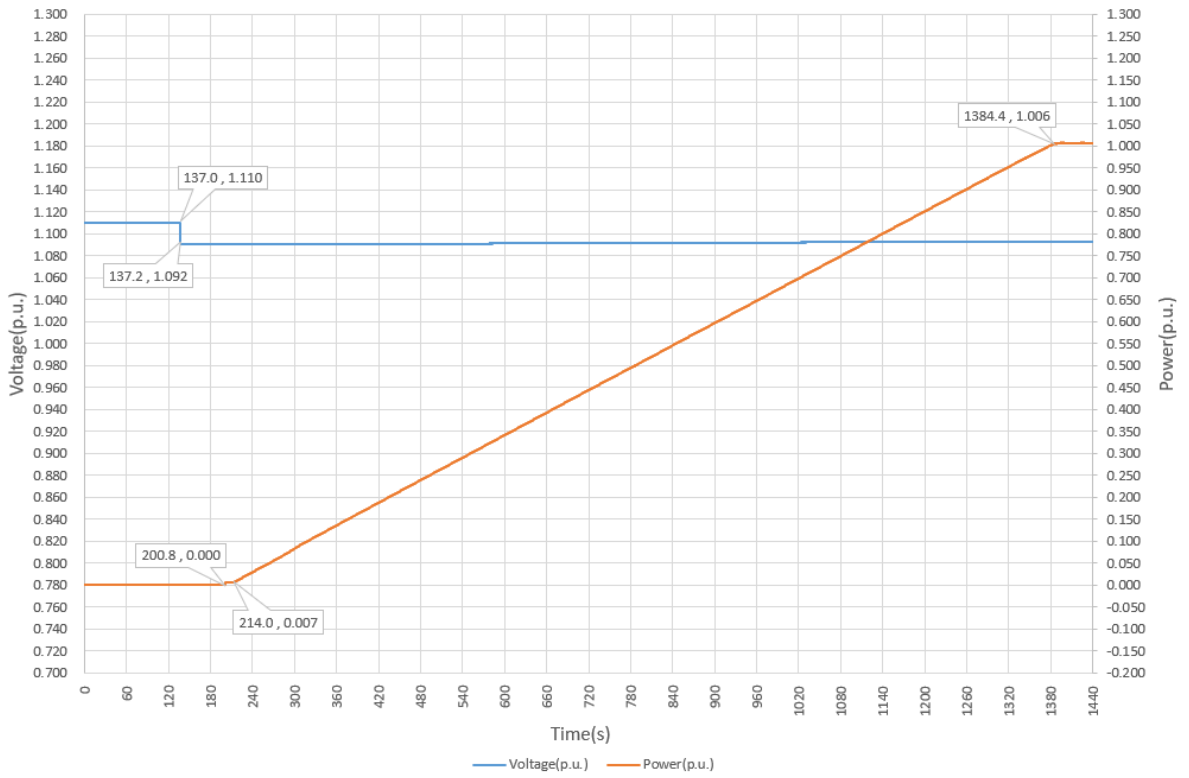

Undervoltage Connection

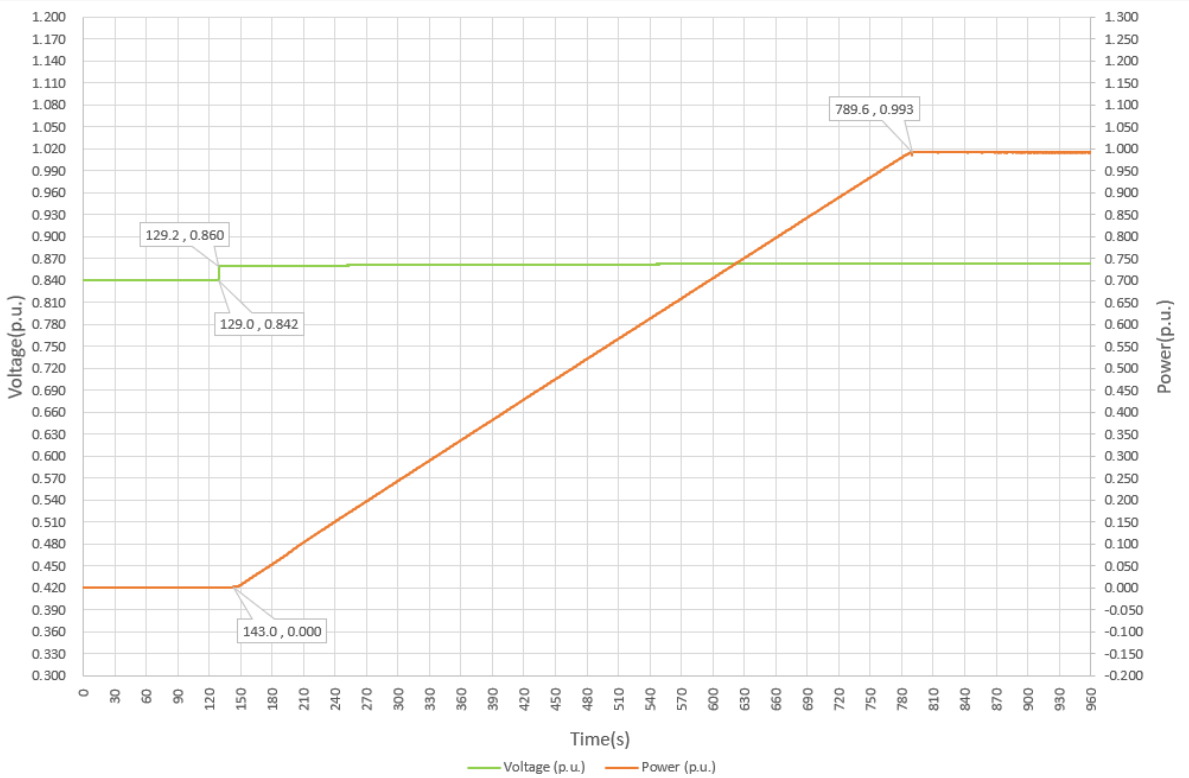



Overfrequency Connection

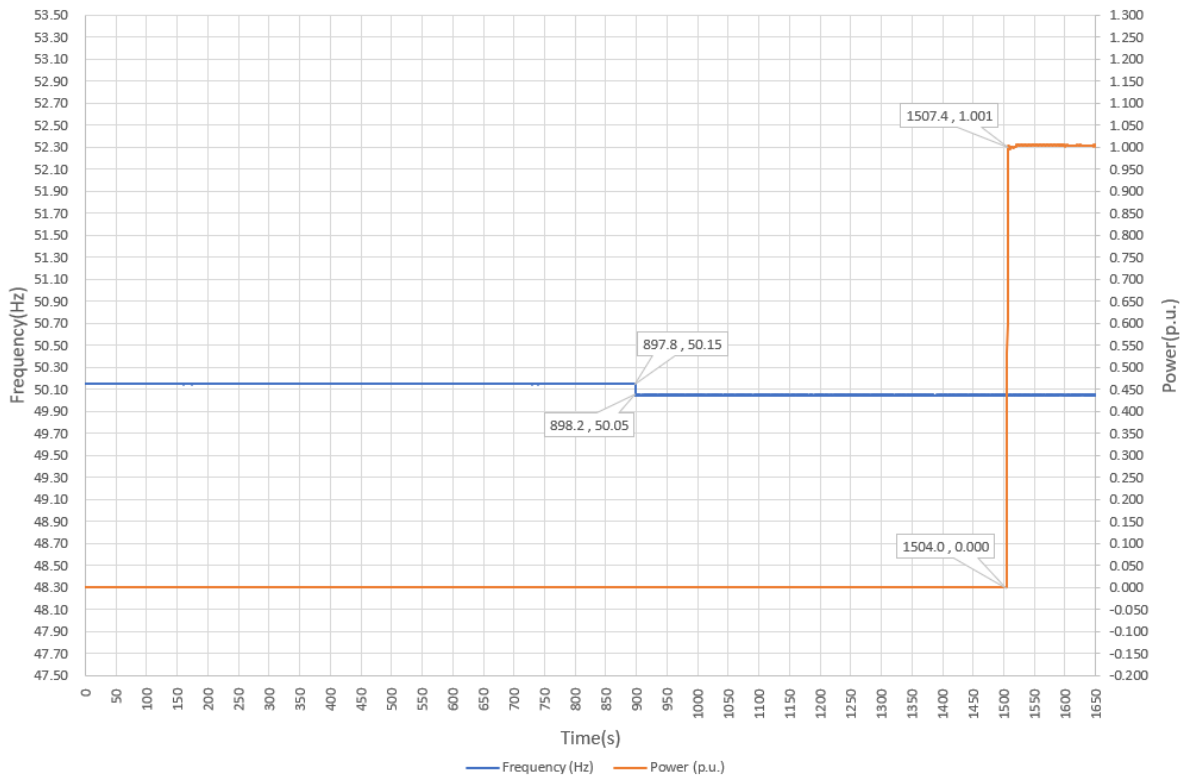

Underfrequency reconnection

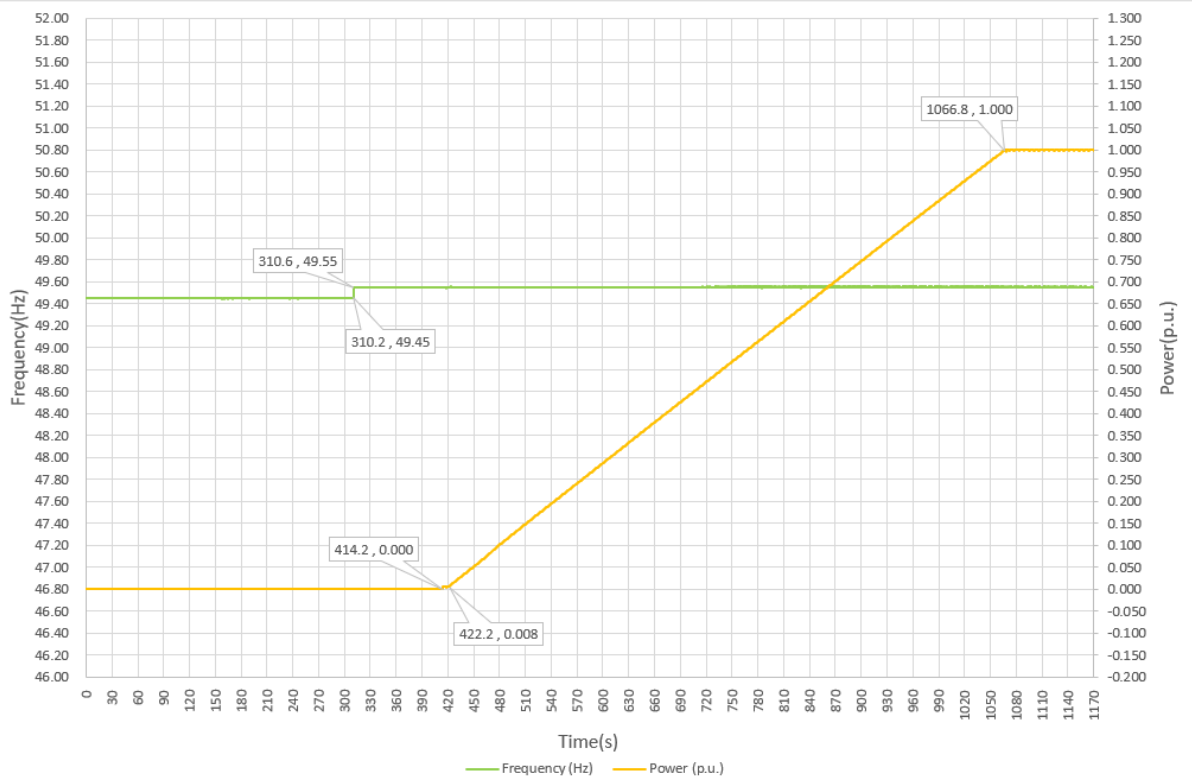

**4.7.3. Synchronization**

The requirements are from clause 4.10.4 of the standard. Synchronizing a generating plant/unit with the distribution network shall be fully automatic.

The EUT is fully automatic in the connection to the distribution network.

**4.8. CEASING AND REDUCTION OF ACTIVE POWER ON SET POINT**

**4.8.1. Ceasing active power**

The test has been done according to the clause 4.11.1 of the standard.

Generating plants with a maximum capacity of 0.8 kW or more shall be equipped with a logic interface (input port) in order to cease active power output within 5 seconds following an instruction being received at the input port. If required by the DSO and the responsible party, this includes remote operation.

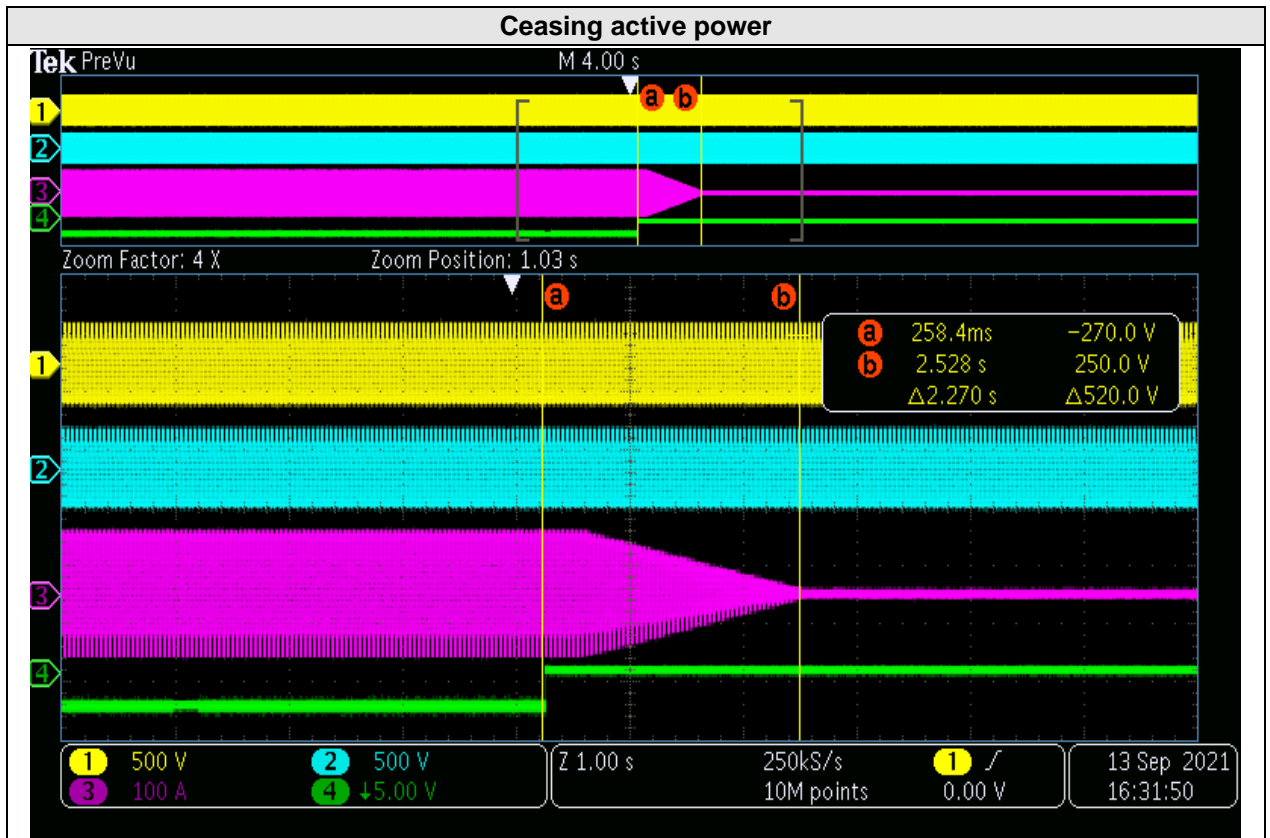

Tested ceasing active power time: 2.270 s

Ch1: Output Voltage ; Ch2: Output Voltage ;  
 Ch3: Phase B current; Ch4: Signal line.

#### 4.8.2. Reduction of active power on set point

Test requirements according to the clause 4.11.2 of the standard.

Active Power step (%P <sub>n</sub> )	Setpoint value		Actual value		Deviation <math>\leq \pm 5\% P_n</math>		Gradient 0.66%P <sub>n</sub> /s to 0.33%P <sub>n</sub> /s (%P <sub>n</sub> /s)
	(kW)	(%P <sub>n</sub> )	(kW)	(%P <sub>n</sub> )	(kW)	(%P <sub>n</sub> )	
100	50.000	100.0	50.018	100.0	+0.018	0.0	--
90	45.000	90.0	45.058	90.1	+0.058	+0.1	0.47
80	40.000	80.0	40.065	80.1	+0.065	+0.1	0.49
70	35.000	70.0	35.053	70.1	+0.053	+0.1	0.49
60	30.000	60.0	30.026	60.1	+0.026	+0.1	0.49
50	25.000	50.0	25.011	50.0	+0.011	0.0	0.49
40	20.000	40.0	20.047	40.1	+0.047	+0.1	0.49
30	15.000	30.0	15.011	30.0	+0.011	+0.0	0.49
20	10.000	20.0	10.026	20.1	+0.026	+0.1	0.49
10	5.000	10.0	5.047	10.1	+0.047	+0.1	0.49
0	0.000	0.0	0.066	0.1	+0.066	+0.1	0.51

Output power reduction by steps (100 %P<sub>n</sub> to 0 %P<sub>n</sub>)

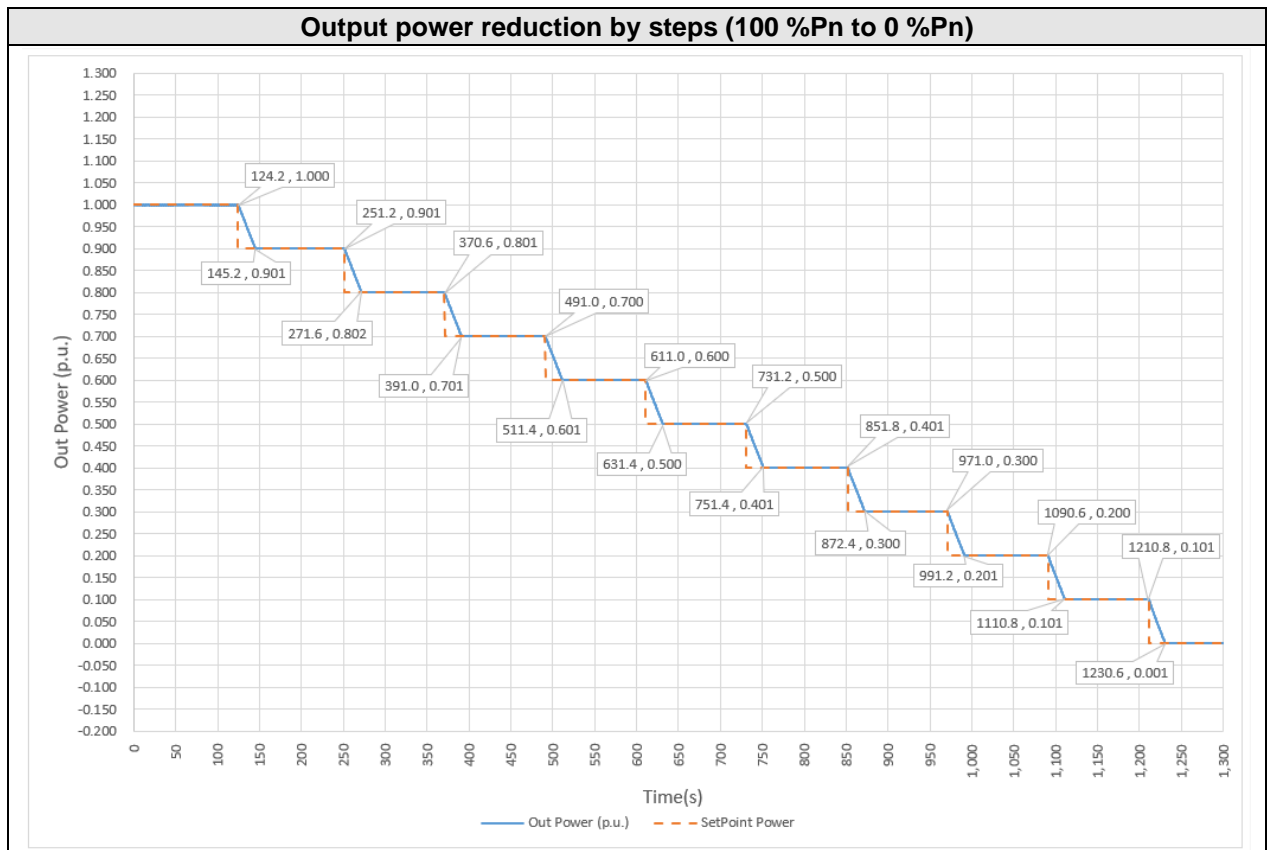

#### **4.9. REQUIREMENTS REGARDING SINGLE FAULT TOLERANCE OF INTERFACE PROTECTION SYSTEM AND INTERFACE SWITCH**

The requirements are from clause 4.3.2 and 4.13 of the standard.

1) The compliances with the requirements of clause 4.3.2 are met with the following structure:

The output is switched off redundant by the high-power switching bridge and two relays, model HFD3/5-SR(825), rated: 250Vac/2A,5Vdc.

2) The compliances with the requirements of clause 4.13 are stated in section 4.4 and section 4.4.4 of the following test report:

IEC/EN 62109-1: 2010: Report No. BL-DG2180298-B01 and IEC/EN 62109-1: 2011: Report No. BL-DG2180298-B02 , issued by Dongguan BALUN Testing Technology Co., Ltd. on Oct.26, 2021. CNAS L14701

5. PICTURES

Front view



Back view



**Connection interface 1  
(SOFAR 25KTLX-G3, SOFAR 30KTLX-G3, SOFAR 30KTLX-G3-A,  
SOFAR 33KTLX-G3, SOFAR 36KTLX-G3, SOFAR 40KTLX-G3-HV)  
COM communication port of manufacturer: Feng Nian**



**Connection interface 2  
(SOFAR 25KTLX-G3, SOFAR 30KTLX-G3, SOFAR 30KTLX-G3-A,  
SOFAR 33KTLX-G3, SOFAR 36KTLX-G3, SOFAR 40KTLX-G3-HV)  
COM communication port of manufacturer: Dian Wei**



**DC Connection interface 1  
(SOFAR 40KTLX-G3, SOFAR 45KTLX-G3, SOFAR 50KTLX-G3, SOFAR 50KTLX-G3-HV)  
COM communication port of manufacturer: Feng Nian**



**DC Connection interface 2  
(SOFAR 40KTLX-G3, SOFAR 45KTLX-G3, SOFAR 50KTLX-G3, SOFAR 50KTLX-G3-HV)  
COM communication port of manufacturer: Dian Wei**



**Side View**  
**(SOFAR 25KTLX-G3, SOFAR 30KTLX-G3, SOFAR 30KTLX-G3-A, SOFAR 33KTLX-G3, SOFAR 36KTLX-G3, SOFAR 40KTLX-G3-HV)**



**Side View**  
**(SOFAR 40KTLX-G3, SOFAR 45KTLX-G3, SOFAR 50KTLX-G3, SOFAR 50KTLX-G3-HV)**





**Internal View**  
**(SOFAR 25KTLX-G3, SOFAR 30KTLX-G3, SOFAR 30KTLX-G3-A,  
SOFAR 33KTLX-G3, SOFAR 36KTLX-G3, SOFAR 40KTLX-G3-HV)**

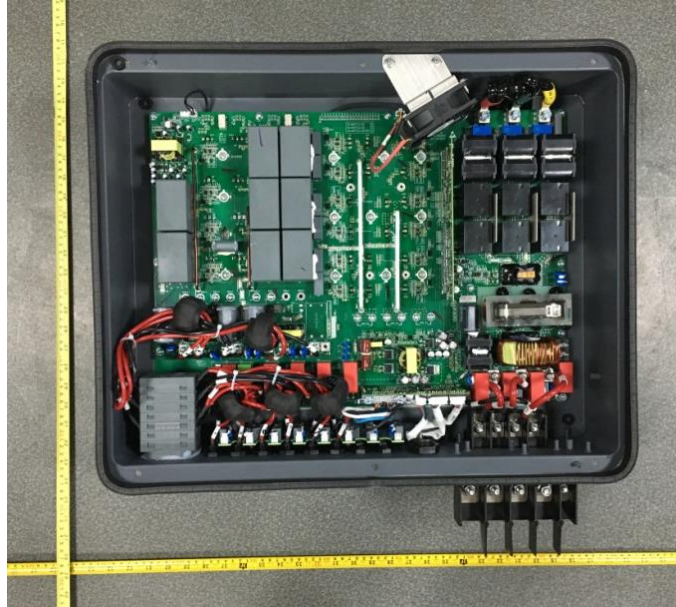

**Internal View**  
**(SOFAR 40KTLX-G3, SOFAR 45KTLX-G3, SOFAR 50KTLX-G3, SOFAR 50KTLX-G3-HV)**

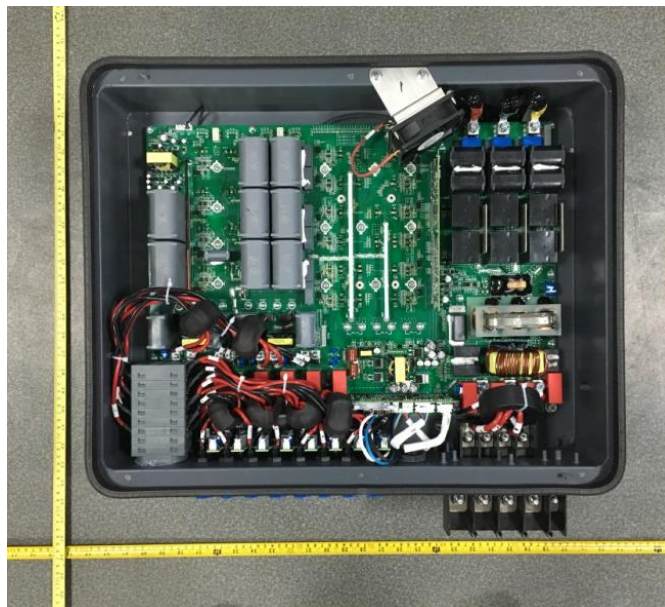

Front side of Power board

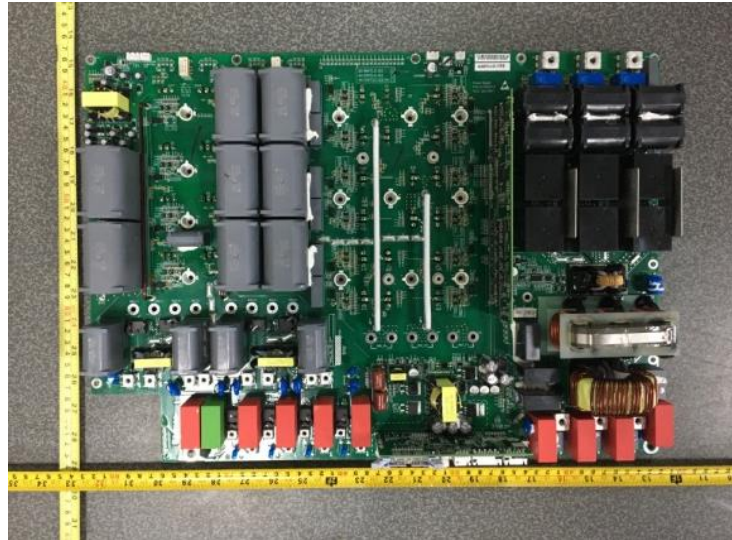

Back side of Power board



Front side of Display board



Back side of Display board

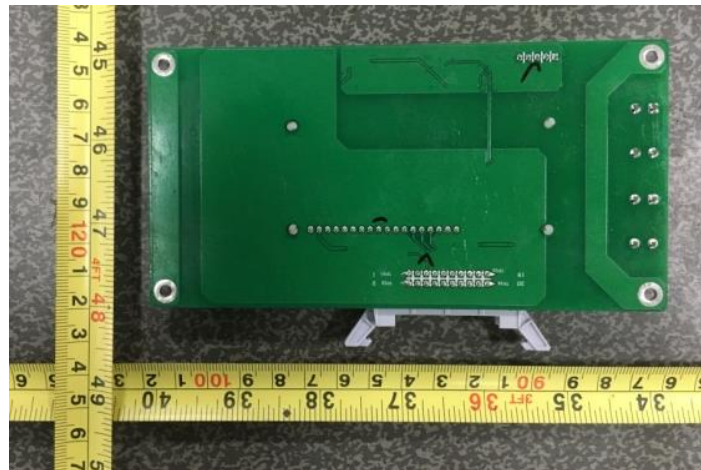

## Serial number

A photograph of a monochrome LCD screen displaying the serial number. The text is in a pixelated font. The screen shows "2. Serial Number" on the first line and "SS3ES250M7F022" on the second line.

2. Serial Number  
SS3ES250M7F022

## Software Version

A photograph of a monochrome LCD screen displaying the software version. The text is in a pixelated font. The screen shows "6. SafetySwVer" on the first line and "V000001" on the second line.

6. SafetySwVer  
V000001

6. ELECTRICAL SCHEME

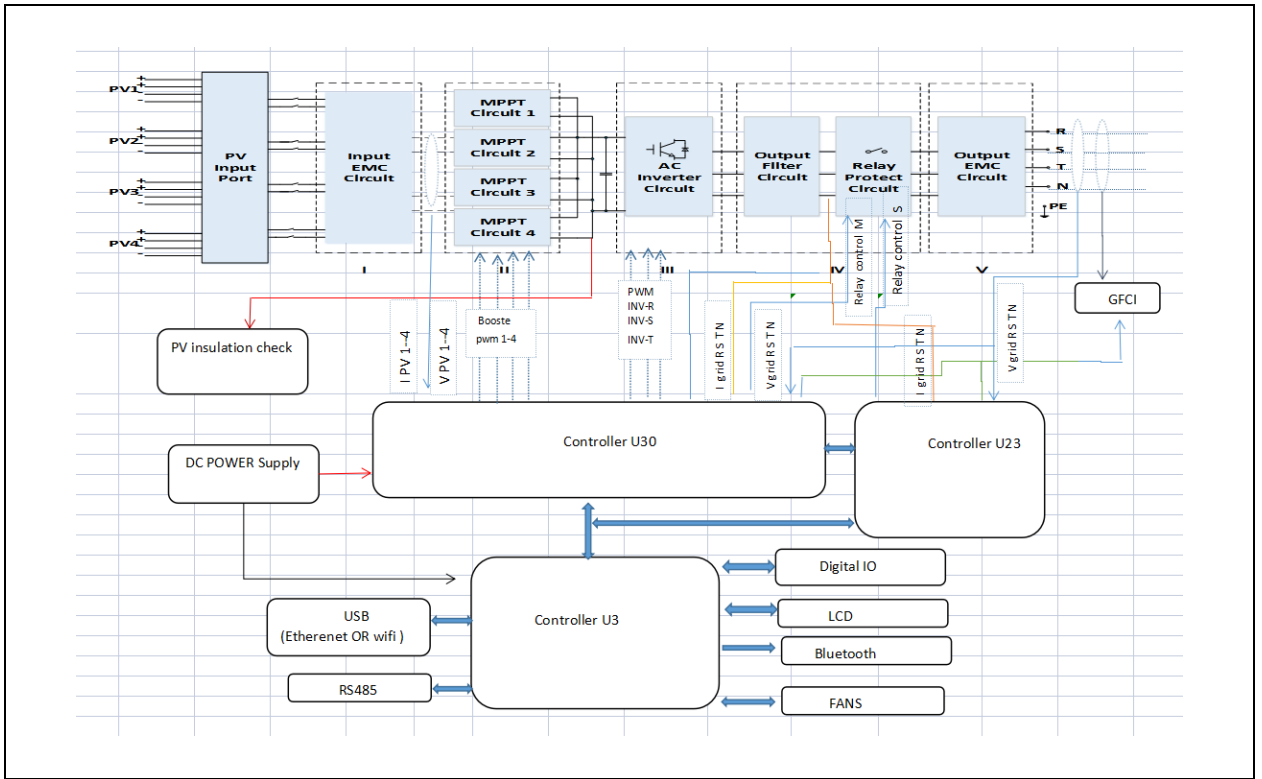

-----End of Report-----